Contents

WF-C5810/WF-C5890 User's Guide	17
Product Basics	18
Installing or Using Optional Parts	18
Optional Accessories and Replacement Parts	18
Installing the Optional Paper Cassette Units	19
Enabling the Optional Paper Cassettes - Windows.....	25
Enabling the Optional Paper Cassettes - PostScript Printer Software - Windows.....	27
Enabling the Optional Paper Cassettes - Mac	29
Enabling the Optional Paper Cassettes - PostScript Printer Software - Mac.....	30
Product Parts Locations	31
Product Parts - Front	32
Product Parts - Inside	34
Product Parts - Back.....	36
Using the Control Panel	37
Control Panel Buttons and Lights	37
Status Icon Information	38
Selecting the Date and Time	39
Selecting Your Country or Region	40
Entering Characters on the LCD Screen	41
Using Presets	41
Changing LCD Screen Language.....	42
Adjusting Control Panel Sounds	42
Adjusting the Screen Brightness.....	43
Turning Off the Operation Time Out Setting	43
Checking for Software Updates.....	44
Using Power Saving Settings	44
Changing the Sleep Timer Settings	45
Changing the Power Off Timer Settings	45
Epson Connect Solutions for Smartphones, Tablets, and More	46
Setting Up Epson Connect Services.....	46

Using Epson Email Print	47
Using Epson Remote Print	47
Using Epson Scan to Cloud	48
Using the Epson Smart Panel Mobile App	49
Using AirPrint	50
Setting Up Printing on a Chromebook	50
Android Printing Using the Epson Print Enabler	51
Using the Mopria Print Service	51
Voice-activated Printing	52
Wi-Fi or Wired Networking	53
Network Security Recommendations	53
Wi-Fi Infrastructure Mode Setup	54
Selecting Wireless Network Settings from the Control Panel	55
Wi-Fi Direct Mode Setup	57
Connecting to a Mobile Device	57
Modifying the Wi-Fi Direct Network Name or Password	58
Wi-Fi Protected Setup (WPS)	60
Using WPS to Connect to a Network	60
Printing a Network Status Sheet	61
Printing a Network Connection Report	61
Network Connection Report Codes and Messages	62
Configuring Email Server Settings	67
Email Server Settings	68
Changing or Updating Network Connections	69
Changing a USB Connection to a Wi-Fi Connection	69
Changing a Wi-Fi Connection to a Wired Network Connection	69
Connecting to a New Wi-Fi Router	70
Disabling Wi-Fi Features	71
Enabling PCL or PostScript Printing	72
Installing the PCL Driver - Windows	72
Installing the PostScript (PS3) Printer Software - Windows	74
Installing the PostScript (PS3) Printer Software - Mac	74
Selecting PDL (Page Description Language) Settings	75

PDL Print Configuration Options.....	75
Selecting Printer Language and Interface Settings	78
Printing Language and Interface Options	78
Printing a PCL or PS3 (PostScript) Status Sheet	79
Loading Paper	80
Loading Paper in the Paper Cassettes and Rear Paper Tray.....	80
Paper Loading Capacity	83
Double-sided Printing Capacity	88
Compatible Epson Papers.....	90
Paper or Media Type Settings - Printing Software.....	92
Selecting the Paper Settings for Each Source - Control Panel	93
Paper Type Settings - Control Panel	93
Selecting Default Paper Settings - Administrator.....	94
Selecting the Default Printer Settings	95
Paper Source Settings Options.....	95
Selecting the Universal Print Settings.....	96
Universal Print Settings Options	97
Placing Originals on the Product	98
Placing Originals in the Automatic Document Feeder	98
Placing Originals on the Scanner Glass	99
Copying.....	101
Copying Documents or Photos.....	101
Copying Options.....	102
Printing from a Computer	105
Printing with the Standard Epson Printer Software - Windows	105
Selecting Basic Print Settings - Windows	106
Paper Source Options - Windows	108
Print Quality Options - Windows	109
Multi-Page Printing Options - Windows.....	109
Selecting Double-sided Printing Settings - Windows	109
Double-sided Printing Options - Windows.....	113
Print Density Adjustments - Windows	113

Selecting Additional Layout and Print Options - Windows	113
Custom Color Correction Options - Windows.....	116
Image Options and Additional Settings - Windows.....	117
Header/Footer Settings - Windows	118
Selecting a Printing Preset - Windows.....	120
Selecting Extended Settings - Windows	121
Extended Settings - Windows	123
Printing Your Document or Photo - Windows.....	125
Locking Printer Settings - Windows	125
Locked Setting Options.....	127
Entering a User ID and Password for Printing	128
Selecting Default Print Settings - Windows.....	130
Changing the Language of the Printer Software Screens	131
Changing Automatic Update Options	132
Printing with the Built-in Epson Driver - Windows 10 S.....	133
Selecting Print Settings - Windows 10 S.....	133
Printing with the Epson Standard Printer Software - Mac.....	137
Selecting Basic Print Settings - Mac	138
Paper Source Options - Mac.....	141
Print Quality Options - Mac	142
Selecting Page Setup Settings - Mac	142
Selecting Print Layout Options - Mac.....	143
Selecting Double-sided Printing Settings - Mac.....	143
Double-sided Printing Options and Adjustments - Mac.....	145
Selecting Printing Preferences - Mac	145
Printing Preferences - Mac.....	146
Printing Your Document or Photo - Mac	147
Checking Print Status - Mac.....	147
Setting Up Printing on a Chromebook	148
Printing from a Smartphone or Tablet.....	149
Printing with the PCL Printer Software - Windows.....	149
Synchronizing Printer Settings - PCL Driver - Windows	149
Selecting Basic Print Settings - PCL Driver - Windows.....	151

Selecting Default Print Settings - PCL Driver - Windows	153
Locking Printer Settings - PCL Driver - Windows.....	154
PCL Driver Locked Setting Options	156
Printing with the PostScript (PS3) Printer Software - Windows	157
Selecting Print Settings - PostScript Printer Software - Windows	157
Selecting Default Print Settings - PostScript Printer Software - Windows.....	159
Printing with the PostScript (PS3) Printer Software - Mac	161
Selecting Basic Print Settings - PostScript Printer Software - Mac	162
Cancelling Printing Using a Product Button.....	166
Scanning	167
Starting a Scan.....	167
Starting a Scan Using the Product Control Panel	167
Scanning to Email	168
Scanning to a Connected Computer	169
Scanning to a Memory Device	170
Scanning to the Cloud.....	171
Setting Up a WSD Port (Windows 7/Windows Vista)	172
Control Panel Scanning Options.....	173
Setting Up and Scanning to a Network Folder or FTP Server	174
Creating a Shared Network Folder.....	175
Registering Contacts for Network Folder or FTP Scanning - Web Config	176
Registering Contacts for Email, Network, or FTP Scanning - Control Panel	177
Scanning to a Network Folder or FTP Server.....	179
Starting a Scan Using the Epson Scan 2 Icon	180
Starting a Scan from a Scanning Program.....	183
Starting a Scan from a Smartphone or Tablet.....	185
Scanning in Epson Scan 2	185
Additional Scanning Settings - Main Settings Tab	188
Additional Scanning Settings - Advanced Settings Tab	189
Saving Scanned Documents as a Searchable PDF Using Epson Scan 2	190
Image Format Options	192
Scan Resolution Guidelines	192
Scanning with Document Capture Pro or Document Capture	193

Scanning with Simple Scan in Document Capture Pro - Windows	193
Scanning with Job Scan in Document Capture Pro - Windows.....	195
Adding and Assigning Scan Jobs with Document Capture Pro - Windows	196
Scanning Two Originals onto One Sheet (Stitching Images) - Windows	199
Scanning Multi-Page Originals as Separate Files - Windows	202
Scanning with Document Capture - Mac	205
Adding and Assigning Scan Jobs with Document Capture - Mac.....	208
Entering a User ID and Password for Scanning	209
Faxing.....	210
Connecting a Telephone or Answering Machine	210
Setting Up Fax Features	213
Setting Up Basic Fax Features	214
Using the Fax Setup Wizard	214
Selecting the Line Type.....	216
Setting the Number of Rings to Answer	217
Selecting Advanced Fax Settings	218
Basic Settings - Fax	219
Send Settings - Fax.....	221
Receive Settings - Fax	222
Report Settings - Fax	225
Security Settings - Fax.....	226
Setting Up the Fax Utility - Windows.....	227
Setting Up Fax Features Using the Fax Utility - Mac	229
Setting Up Contacts and Contact Groups.....	230
Creating a Contact.....	231
Editing or Deleting a Contact	232
Creating a Contact Group.....	232
Editing or Deleting a Contact Group	233
Sending Faxes	234
Sending Faxes from the Product Control Panel.....	234
Sending a Fax Using the Keypad, Contact List, or History	234
Fax Sending Options	236
Sending a Fax at a Specified Time	238

Sending a Fax on Demand	239
Sending a Stored Fax	240
Dialing Fax Numbers from a Connected Telephone	240
Sending Faxes Using the Fax Utility - Windows	241
Sending Faxes Using the Fax Utility - Mac	244
Receiving Faxes.....	247
Fax Reception	247
Receiving Faxes Automatically	248
Receiving Faxes Manually.....	248
Forwarding Received Faxes.....	249
Receiving a Fax by Polling	249
Checking Fax Status	250
Viewing a Fax on the LCD Screen (Using the Fax Box)	250
Printing Fax Reports.....	251
Fax Report Options	252
Using External USB Devices with Your Product.....	253
Connecting a USB Device	253
Disconnecting a USB Device.....	253
Viewing and Printing from the LCD Screen	254
Printing JPEG Photos.....	254
Print Setting Options - JPEG Mode.....	255
Printing TIFF and PDF Files	256
Print Setting Options - TIFF Mode.....	257
Print Setting Options - PDF Mode.....	258
Transferring Files on a USB Device	259
Setting Up File Sharing for File Transfers from Your Computer.....	259
Transferring Files from a USB Device to Your Computer	260
Replacing Ink Supply Units (Ink Packs), Maintenance Boxes, and Cassette Rollers	262
Ink Pack Safety Instructions	262
Check Ink and Maintenance Box Status.....	263
Checking Ink Status on the LCD Screen.....	264
Checking Ink and Maintenance Box Status - Windows.....	264
Checking Ink and Maintenance Box Status - Mac	266

Purchase Epson Ink Packs and Maintenance Boxes	267
Ink Supply Unit (Ink Pack) and Maintenance Box Part Numbers	268
Removing and Installing Ink Packs.....	268
Replacing the Maintenance Box.....	269
Replacing the Paper Feed Rollers	270
Resetting the Roller Counter on the LCD Screen	270
Printing with Black Ink and Expanded Color Ink Packs	271
Printing with Expanded Color Ink Packs - Windows	271
Printing with Expanded Color Ink Packs - Mac	272
Conserving Low Black Ink with Windows	274
Adjusting Print Quality.....	275
Print Head Maintenance.....	275
Print Head Nozzle Check.....	275
Checking the Nozzles Using the Product Control Panel	275
Checking the Nozzles Using a Computer Utility	276
Print Head Cleaning	278
Cleaning the Print Head Using the Product Control Panel	279
Cleaning the Print Head Using a Computer Utility.....	280
Print Head Alignment	281
Aligning the Print Head Using the Product Control Panel	282
Adjusting the Print Quality Using the Product Control Panel.....	282
Cleaning the Paper Guide	283
Cleaning the Translucent Film.....	284
Checking the Number of Sheets on the LCD Screen	286
Cleaning and Transporting Your Product	287
Cleaning Your Product	287
Cleaning the Scanner Glass.....	288
Cleaning the Automatic Document Feeder.....	289
Transporting Your Product	292
Administering Your Product.....	299
Accessing the Web Config Utility.....	299
Changing the Administrator Password in Web Config	300
Configuring Product Settings.....	301

Checking Status Information	302
Managing the Network Connection.....	302
Network Settings.....	303
Setting Control Panel Options	307
Sending Email Notifications.....	307
Adjusting Power Saving Settings.....	308
Adjusting Control Panel Sounds	309
Importing and Exporting Product Settings	309
Exporting Settings Using Web Config	309
Importing Settings Using Web Config	310
Updating Firmware Using Web Config	310
Synchronizing the Date and Time with a Time Server	311
Clearing the Internal Memory	311
Adjusting the Contact List View Options	312
Enabling Periodic Cleaning	312
Powering Off or Rebooting the Product Remotely	312
Restoring Default Product Settings.....	313
Configuring Security Settings	313
Connecting an Authentication Device.....	314
Restricting Features Available for Users	315
User Feature Restriction	315
Configuring User Feature Restrictions	315
Disabling the External Interface.....	316
Setting Up Password Encryption	317
Working with Audit Logs	317
Restricting PDL File Operations	318
Enabling Program Verification on Start Up	318
Restricting Domain Access.....	318
Using Your Product on a Secure Network	319
Configuring Protocols and Services in Web Config	319
Protocol Settings.....	319
Configuring SSL/TLS Communication.....	324
Configuring SSL/TLS Settings	324

Configuring a Server Certificate for the Product.....	324
Configuring IPsec/IP Filtering	325
About IPsec/IP Filtering	325
Configuring the Default IPsec/IP Filtering Policy	325
Configuring the Group IPsec/IP Filtering Policies	326
IPsec/IP Filtering Policy Settings	326
IPsec/IP Filtering Configuration Examples.....	331
Configuring an IPsec/IP Filtering Certificate	332
Connecting the Product to an IEEE 802.1X Network.....	333
Configuring an IEEE 802.1X Network.....	333
IEEE 802.1X Network Settings	333
Configuring a Certificate for an IEEE 802.1X Network.....	334
IEEE 802.1X Network Status	334
Using a Digital Certificate	335
About Digital Certification.....	336
Obtaining and Importing a CA-signed Certificate.....	336
CSR Setup Settings	337
CSR Import Settings	337
Deleting a CA-signed Certificate.....	339
Updating a Self-signed Certificate.....	339
Importing a CA Certificate.....	340
Deleting a CA Certificate.....	340
Setting Up Universal Print (Microsoft)	340
Using Epson Device Admin Configuration Software.....	341
Solving Problems	342
Viewing the Help Screen	342
Product Status Messages	343
Job Status Error Codes	346
Running a Product Check	350
Resetting Control Panel Defaults	351
Solving Setup Problems	352
Product Does Not Turn On or Off.....	353
Noise After Ink Installation.....	353

Software Installation Problems	353
Cannot Read the Authentication Card	354
Solving Network Problems	354
Product Cannot Connect to a Wireless Router or Access Point	355
Network Software Cannot Find Product on a Network.....	356
Wireless Network Connection is Unstable on a Mac	357
USB 3.0 Connection is Unstable When Using a USB 2.0 Cable.....	357
Product Does Not Appear in Mac Printer Window	358
Cannot Print Over a Network.....	358
Cannot Scan Over a Network	360
Solving Network Security Problems	361
Cannot Create the Secure IPP Printing Port.....	361
Cannot Update a Certificate or Create a CSR	361
Cannot Import a Digital Certificate.....	362
Deleted a CA-signed Certificate	362
Digital Certificate Warning Messages.....	362
Solving Copying Problems	364
Product Makes Noise, But Nothing Copies.....	364
Product Makes Noise When It Sits for a While.....	365
Solving Copy Quality Problems	365
Copies Have Incorrect or Faint Colors.....	365
Position, Size, or Margins of Copies are Incorrect	366
Solving Paper Problems	366
Paper Feeding Problems.....	367
Originals Do Not Feed From the Automatic Document Feeder.....	368
Paper Jams Inside the Product.....	369
Paper Ejection Problems	369
Solving Problems Printing from a Computer.....	369
Nothing Prints	370
Product Icon Does Not Appear in Windows Taskbar	371
Printing is Slow	372
Solving Page Layout and Content Problems	374
Inverted Image.....	374

Too Many Copies Print	375
Blank Pages Print	375
Incorrect Margins on Printout.....	375
Incorrect Characters Print.....	376
Incorrect Image Size or Position	377
Slanted Printout	377
Solving Print Quality Problems	378
White or Dark Lines in Printout	379
Blurry or Smearred Printout	379
Faint Printout or Printout Has Gaps	381
Grainy Printout.....	382
Incorrect Colors	383
Solving Scanning Problems	384
Scanning Software Does Not Operate Correctly	384
Cannot Start Epson Scan 2	384
Solving Scanned Image Quality Problems	385
Image Consists of a Few Dots Only.....	386
Line of Dots Appears in All Scanned Images	386
Straight Lines in an Image Appear Crooked	387
Scanned Image Quality Problems	387
Image Colors are Patchy at the Edges	389
Ripple Patterns Appear in an Image	389
Scanned Image Edges are Cropped	389
Solving Faxing Problems.....	389
Cannot Send or Receive Faxes	390
Cannot Receive Faxes with a Telephone Connected to Your Product	392
Fax Memory Full Error Appears.....	393
Fax Quality is Poor	394
Sent Fax is Received in an Incorrect Size	395
Received Fax is Not Printed	395
Solving USB Device Problems	395
Cannot View or Print from a USB Device.....	396
Cannot Save Files on a USB Device	396

Cannot Transfer Files To or From a USB Device.....	397
Uninstall Your Product Software.....	397
Uninstalling Product Software - Windows.....	397
Uninstalling Product Software - Mac.....	398
Where to Get Help (U.S. and Canada).....	399
Where to Get Help (Latin America).....	400
Technical Specifications	402
Windows System Requirements	402
Mac System Requirements	403
Paper Specifications	403
Printable Area Specifications	405
Automatic Document Feeder (ADF) Specifications	406
Scanning Specifications	407
Fax Specifications	407
Ink Pack Specifications	409
Dimension Specifications	410
Electrical Specifications	410
Environmental Specifications	411
Interface Specifications	412
External USB Device Specifications.....	412
Network Interface Specifications	413
Safety and Approvals Specifications	416
Notices	417
Important Safety Instructions.....	417
General Printer Safety Instructions.....	417
Wireless Connection Safety Instructions	419
Telephone Equipment Safety Instructions	419
LCD Screen Safety Instructions.....	420
FCC Compliance Statement.....	420
Binding Arbitration and Class Waiver	421
Trademarks	424
Copyright Notice.....	425
libTIFF Software Acknowledgment.....	425

A Note Concerning Responsible Use of Copyrighted Materials.....	426
Default Delay Times for Power Management for Epson Products	426
Copyright Attribution	426

WF-C5810/WF-C5890 User's Guide

Welcome to the WF-C5810/WF-C5890 *User's Guide*.

For a printable PDF copy of this guide, [click here](#).

Note: Availability of products in this guide varies by country.

Product Basics

See these sections to learn about the basic features of your product.

Note: Printing software instructions in this manual are intended for use with the standard Epson printer software. For more information on using the Printer Command Language (PCL) or PostScript (PS3) printer software, please see the appropriate sections (WF-C5890).

[Installing or Using Optional Parts](#)

[Product Parts Locations](#)

[Using the Control Panel](#)

[Checking for Software Updates](#)

[Using Power Saving Settings](#)

[Epson Connect Solutions for Smartphones, Tablets, and More](#)

[Using the Epson Smart Panel Mobile App](#)

[Using AirPrint](#)

[Setting Up Printing on a Chromebook](#)

[Android Printing Using the Epson Print Enabler](#)

[Using the Mopria Print Service](#)

[Voice-activated Printing](#)

Installing or Using Optional Parts

Follow the instructions in this section to install or use optional parts.

[Optional Accessories and Replacement Parts](#)

[Installing the Optional Paper Cassette Units](#)

Parent topic: [Product Basics](#)

Optional Accessories and Replacement Parts

You can purchase genuine Epson accessories at epson.com (U.S. sales), epson.ca (Canadian sales), or latin.epson.com (Latin American sales). You can also purchase supplies from an Epson authorized reseller. To find the nearest one, call 800-GO-EPSON (800-463-7766) in the U.S. or 800-807-7766 in Canada.

U.S. and Canada

Option or part	Part number
Replacement maintenance box	C12C938211
Optional input tray	C12C937901
Paper Feed Roller for Cassette A (C1)	C12C938261
Paper Feed Roller for Cassette B (C2-C4)	C12C938281
Low Optional Cabinet	C12CFM7066
Medium Optional Cabinet	C12CFM7067
Tall Optional Cabinet	C12CFM7068

Latin America

Option or part	Part number
Replacement maintenance box	C12C938211
Optional input tray	C12C937901
Paper Feed Roller for Cassette A (C1)	C12C938261
Paper Feed Roller for Cassette B (C2-C4)	C12C938281

Parent topic: [Installing or Using Optional Parts](#)

Installing the Optional Paper Cassette Units

You can install up to three optional paper cassette units to provide more paper capacity.

1. Turn off the product, and unplug the power cord and any connected cables.

Warning: To avoid electric shock, make sure you unplug the power cord.

2. Remove the paper cassette unit from its packaging and remove any protective materials.

3. Make sure you have all the items shown here. You will also need a screwdriver to attach the paper cassette unit, and two people to lift the printer.

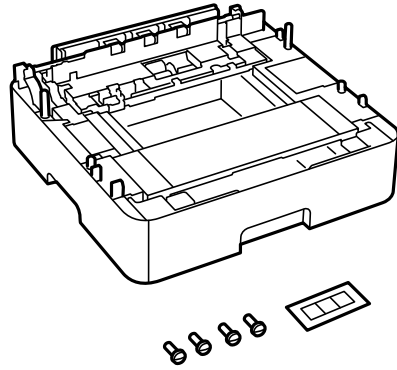

4. Remove the protective piece from the back of the printer.

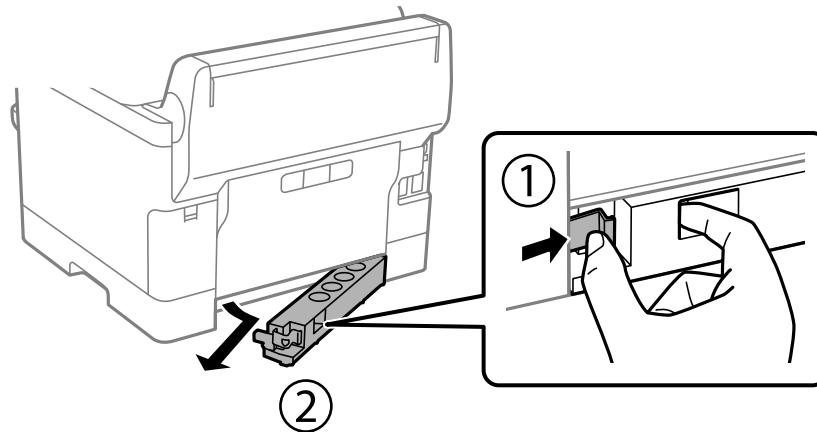

Note: Do not throw the piece away; you will use it later.

5. Place the first optional paper cassette unit in the location where you want to set up the printer.

6. If you are installing more than one optional paper cassette unit, stack them on top of each other and secure them with the included screws.

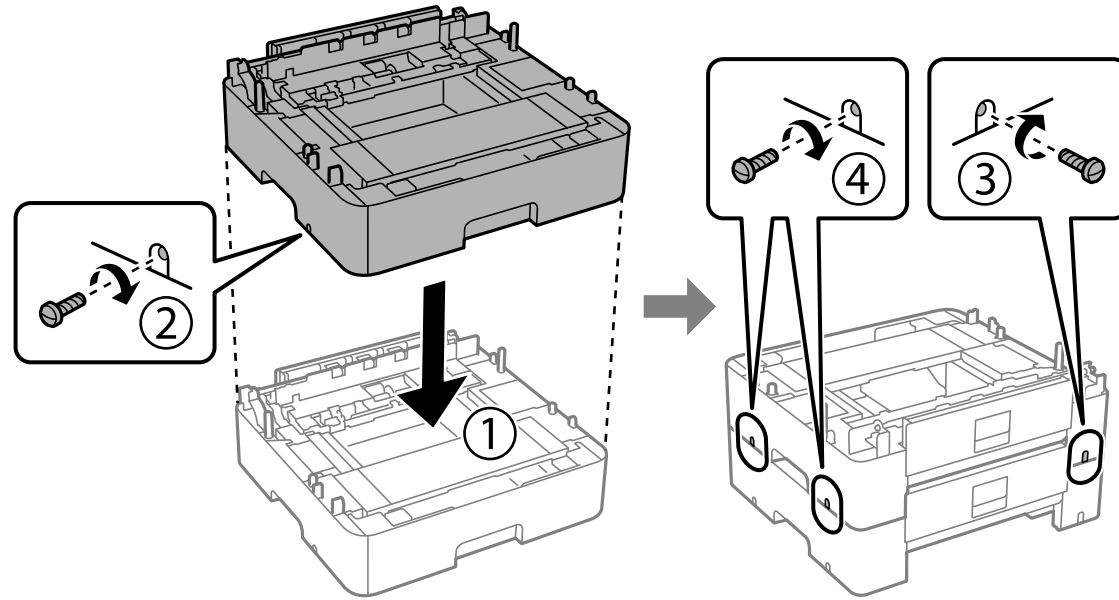

7. Repeat this step for all paper cassette units.

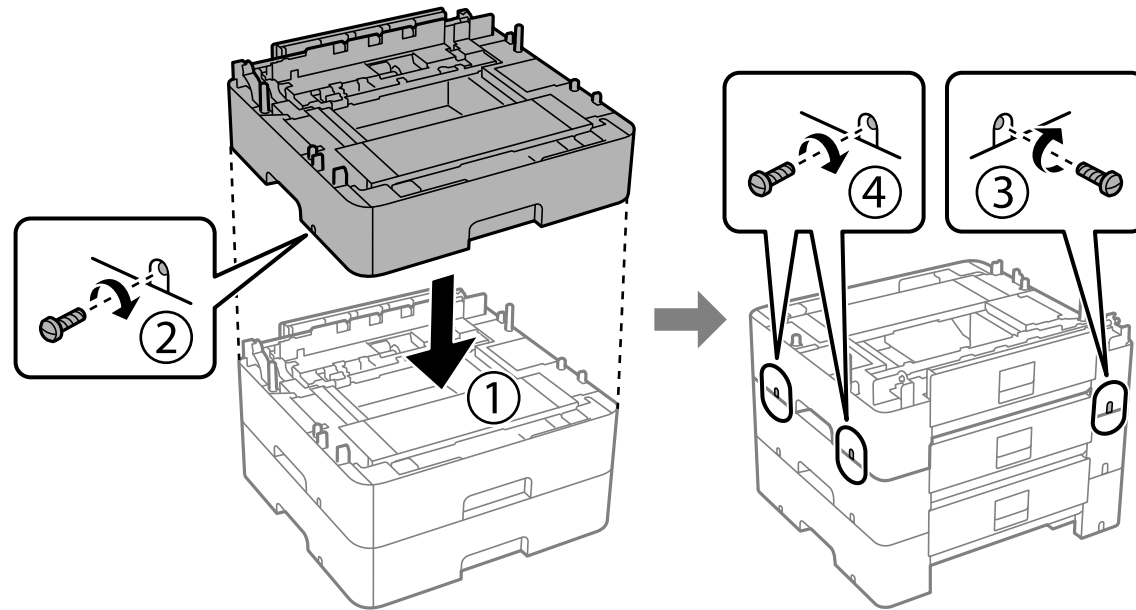

8. Lift up your product and gently lower it onto the paper cassette unit with the corners aligned. Secure the product to the paper cassette unit using the included screws.

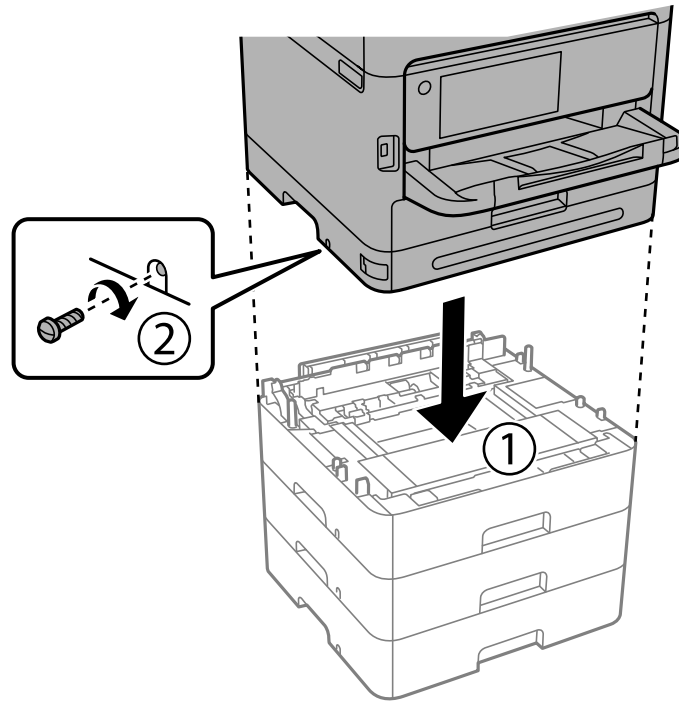

Caution: Because the product is heavy, two or more people should lift and carry it using the hand positions shown:

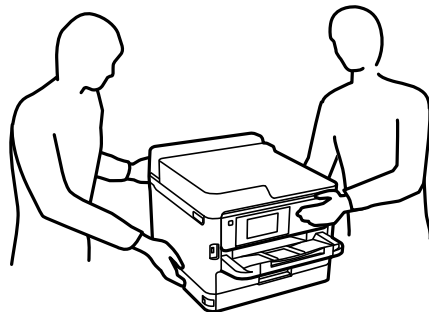

9. Secure the printer and paper cassette units at the back and right side using the included screws as shown.

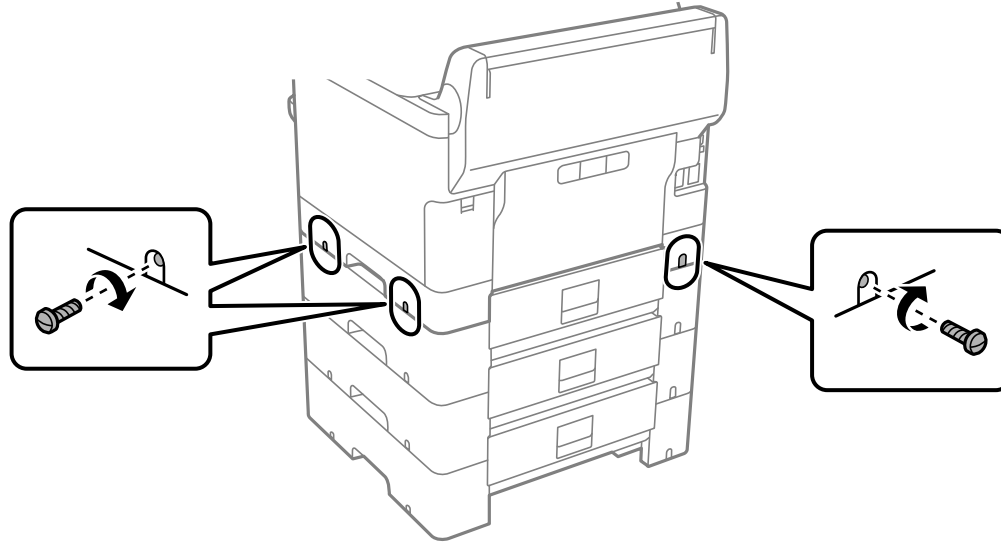

10. Re-insert the part you removed earlier into the back of the lowest paper cassette unit.

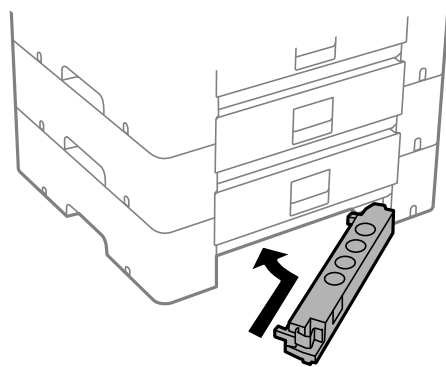

11. Place the correct sticker on each cassette unit to indicate the cassette number.

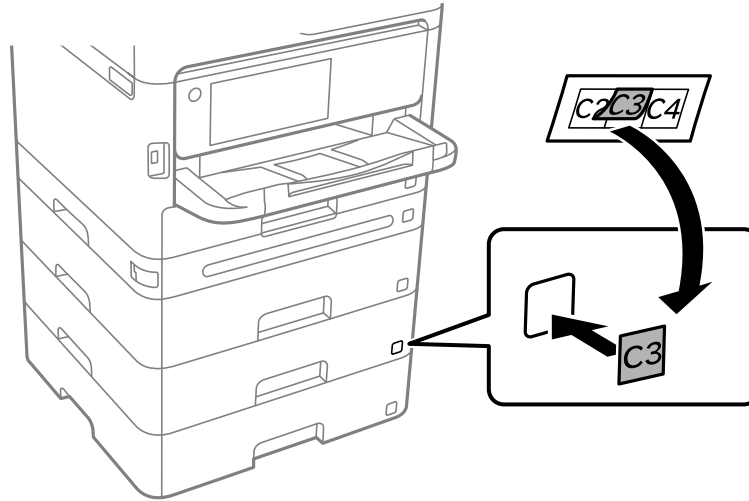

12. Connect the power cord and other connection cables, then plug in the product.
13. Turn on the product.
14. Press the **Paper Setting** button and make sure the installed cassette units are displayed on the screen.
15. Enable the optional paper cassette units in the printer software.

[Enabling the Optional Paper Cassettes - Windows](#)

[Enabling the Optional Paper Cassettes - PostScript Printer Software - Windows](#)

[Enabling the Optional Paper Cassettes - Mac](#)

[Enabling the Optional Paper Cassettes - PostScript Printer Software - Mac](#)

Parent topic: [Installing or Using Optional Parts](#)

Related tasks





[Synchronizing Printer Settings - PCL Driver - Windows](#)

Enabling the Optional Paper Cassettes - Windows

You need to enable the optional paper cassette units before you can use them with the printer software.

Note: If you are using the PCL driver or PostScript (PS3) printer software, see the link below to enable the optional cassette units.

1. Do one of the following:

- **Windows 11:** Click , search for **Settings** and select it. Select **Bluetooth & devices > Printers & scanners**. Select your product name, then select **Printer properties**.
- **Windows 10:** Click  and select  (Settings) > **Devices > Printers & scanners**. Select your product name and select **Manage > Printer properties**.
- **Windows 8.x:** Navigate to the **Apps** screen and select **Control Panel > Hardware and Sound > Devices and Printers**. Right-click your product name and select **Printer properties**.
- **Windows 7:** Click  and select **Devices and Printers**. Right-click your printer name and select **Printer properties**.
- **Windows Vista:** Click  and select **Control Panel**. Click **Printer** under **Hardware and Sound**, then right-click your printer name and select **Properties**.

2. Click the **Optional Settings** tab.

You see a window like this:

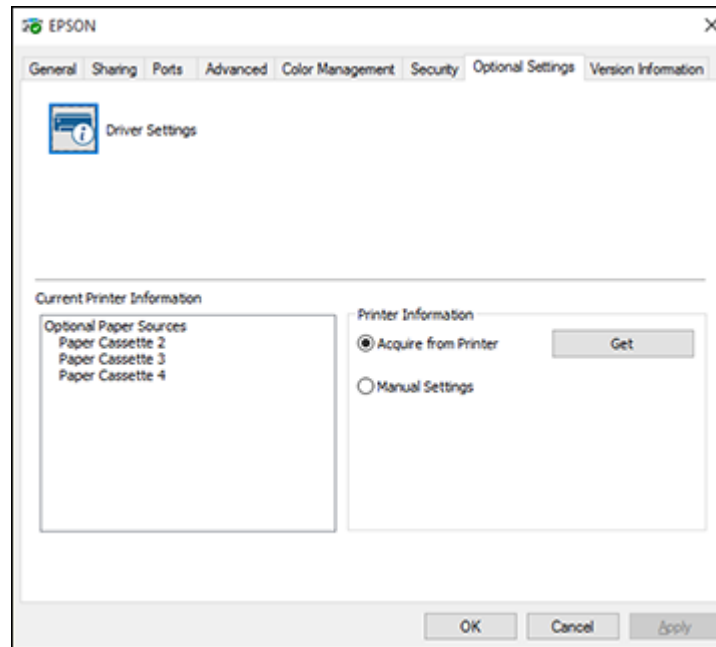

3. Make sure **Acquire from Printer** is selected and click **Get**.

The optional paper sources are listed in the Current Printer Information section.

4. Click **OK**.

The optional paper cassettes are now enabled.





Parent topic: [Installing the Optional Paper Cassette Units](#)

Related tasks

[Enabling the Optional Paper Cassettes - PostScript Printer Software - Windows](#)

Enabling the Optional Paper Cassettes - PostScript Printer Software - Windows

If you installed optional paper cassette units, you need to enable the optional cassette units before you can use them with the PS3 printer software.

1. Do one of the following:
 - **Windows 11:** Click , search for **Settings** and select it. Select **Bluetooth & devices > Printers & scanners**. Select your product name, then select **Printer properties**.
 - **Windows 10:** Click  and select  (Settings) > **Devices > Printers & scanners** . Select your product name and select **Manage > Printer properties**.
 - **Windows 8.x:** Navigate to the **Apps** screen and select **Control Panel > Hardware and Sound > Devices and Printers**. Right-click your product name and select **Printer properties**.
 - **Windows 7:** Click  and select **Devices and Printers**. Right-click your product name and select **Printer Properties**.
 - **Windows Vista:** Click  and select **Control Panel**. Click **Printer** under **Hardware and Sound**, then right-click your product name, and select **Properties**.
2. Click the **Device Settings** tab.

You see a window like this:

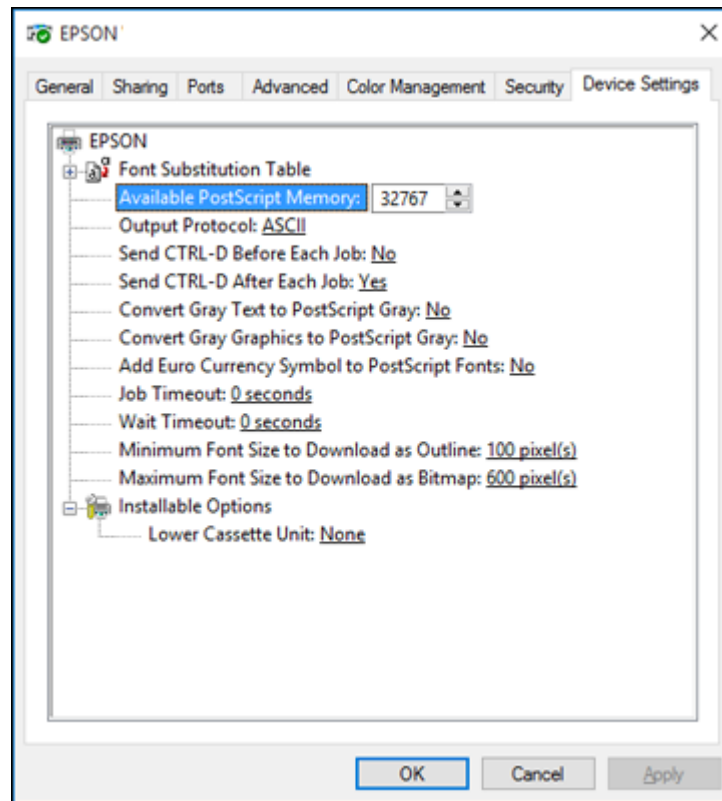

3. Select the number of optional cassettes installed as the Lower Cassette Unit setting.
4. Click **OK**.

The optional paper cassettes are now enabled.

Parent topic: [Installing the Optional Paper Cassette Units](#)

Enabling the Optional Paper Cassettes - Mac

You need to enable the optional paper cassette units before you can use them with the printer software.

Note: If you are using the PostScript (PS3) printer software, see the link below to enable the optional cassette units.

1. In the Apple menu or the Dock, select **System Preferences**.
2. Select **Print & Fax**, **Print & Scan**, or **Printers & Scanners**, select your product, and select **Options & Supplies**.
3. Select **Driver** or **Options**.

You see a screen like this:

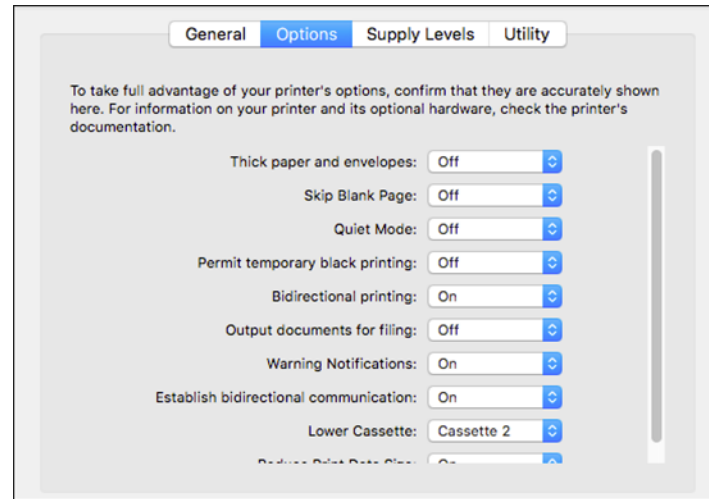

4. Select the number of cassette units installed as the **Lower Cassette** setting.
5. Click **OK**.

The optional paper cassettes are now enabled.

Parent topic: [Installing the Optional Paper Cassette Units](#)

Related tasks

[Enabling the Optional Paper Cassettes - PostScript Printer Software - Mac](#)

Enabling the Optional Paper Cassettes - PostScript Printer Software - Mac

If you installed optional paper cassette units, you need to enable the optional cassette units before you can use them with the PS3 printer software.

1. In the Apple menu or the Dock, select **System Preferences**.
2. Select **Print & Fax**, **Print & Scan**, or **Printers & Scanners**, select your product, and select **Options & Supplies**.

3. Select **Driver** or **Options**.

You see a screen like this:

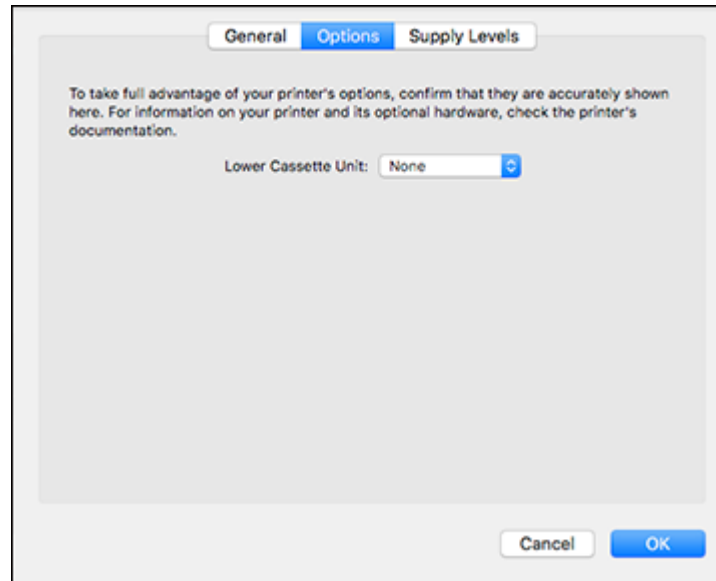

4. Select the number of optional cassettes installed as the Lower Cassette Unit setting.

5. Click **OK**.

The optional paper cassettes are now enabled.

Parent topic: [Installing the Optional Paper Cassette Units](#)

Product Parts Locations

See these sections to identify the parts on your product.

[Product Parts - Front](#)

[Product Parts - Inside](#)

[Product Parts - Back](#)

Parent topic: [Product Basics](#)

Product Parts - Front

Certain parts are labeled with a letter and number code. If you encounter any paper jams or errors, you can use these codes to locate and correct the problem.

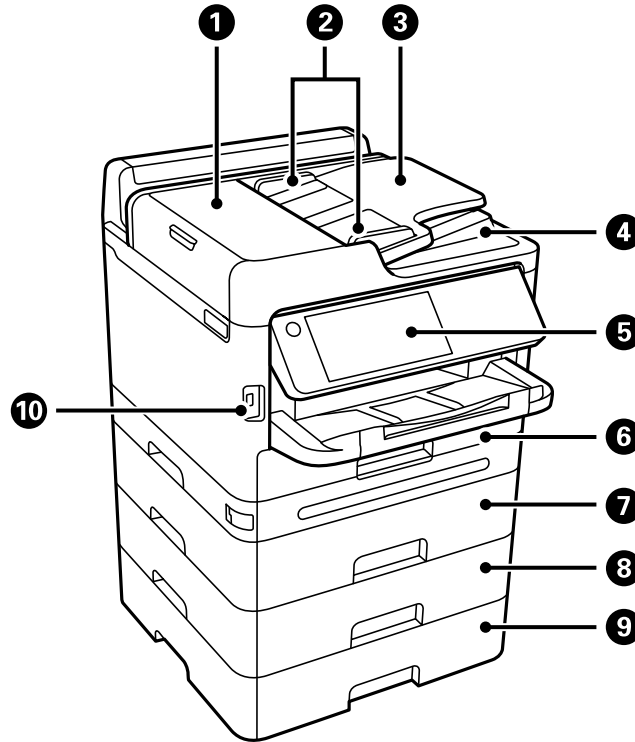

- 1 Automatic Document Feeder (ADF) cover (F)
- 2 ADF edge guides
- 3 ADF input tray
- 4 ADF output tray
- 5 Control panel
- 6 Paper cassette 1 (C1)
- 7 Optional paper cassette 2 (C2)

- 8 Optional paper cassette 3 (C3)
- 9 Optional paper cassette 4 (C4)
- 10 External interface USB port

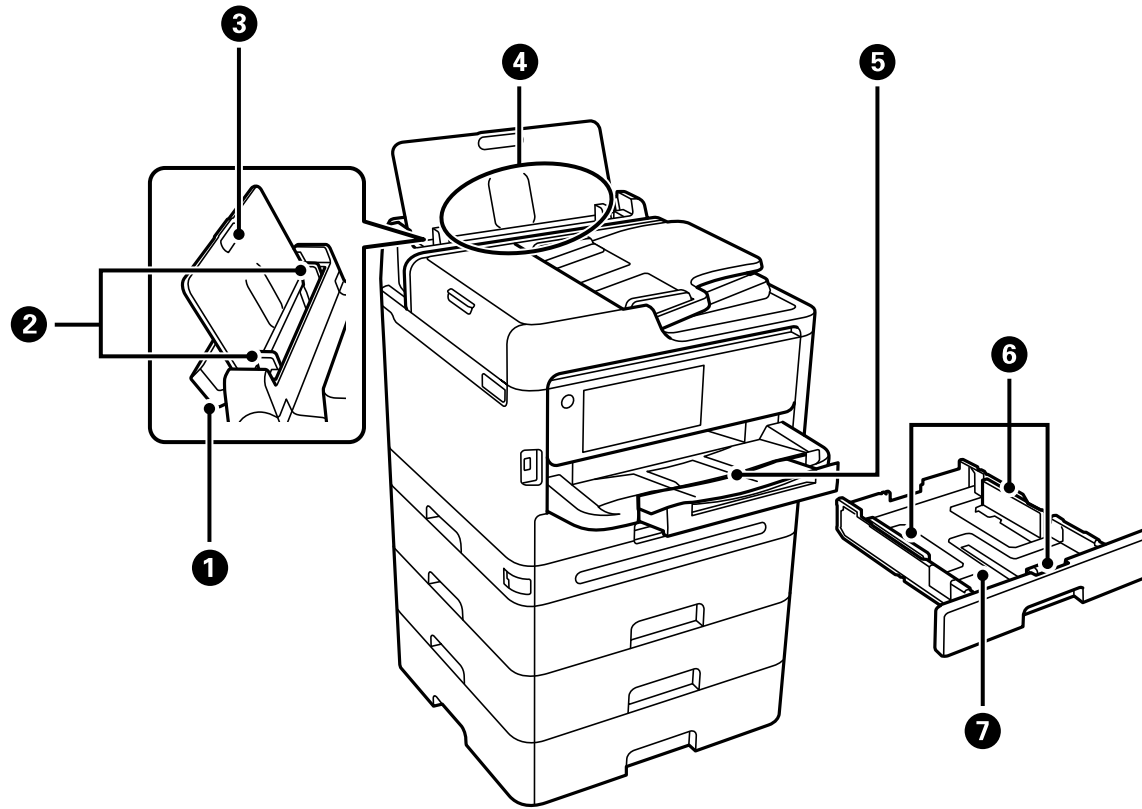

- 1 Paper tray cover
- 2 Edge guides
- 3 Paper support
- 4 Paper tray (B)
- 5 Output tray

- 6 Edge guides
- 7 Paper cassette

Parent topic: [Product Parts Locations](#)

Product Parts - Inside

Certain parts are labeled with a letter and number code. If you encounter any paper jams or errors, use these codes to locate and correct the problem.

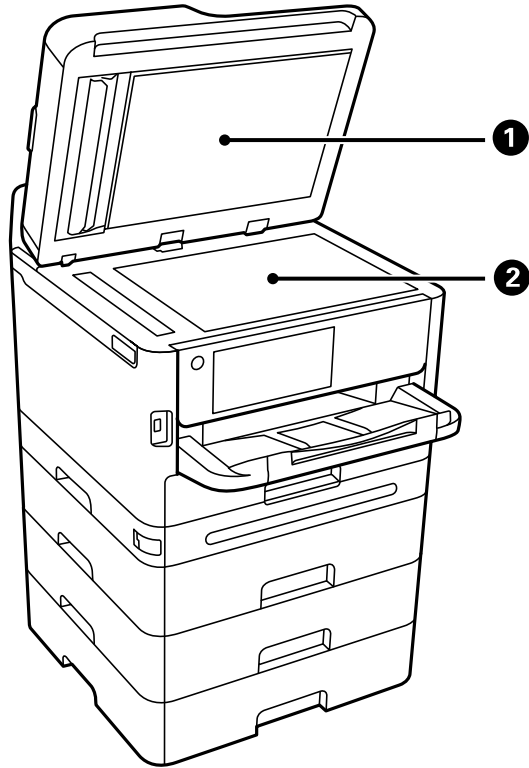

- 1 Document cover

2 Scanner glass

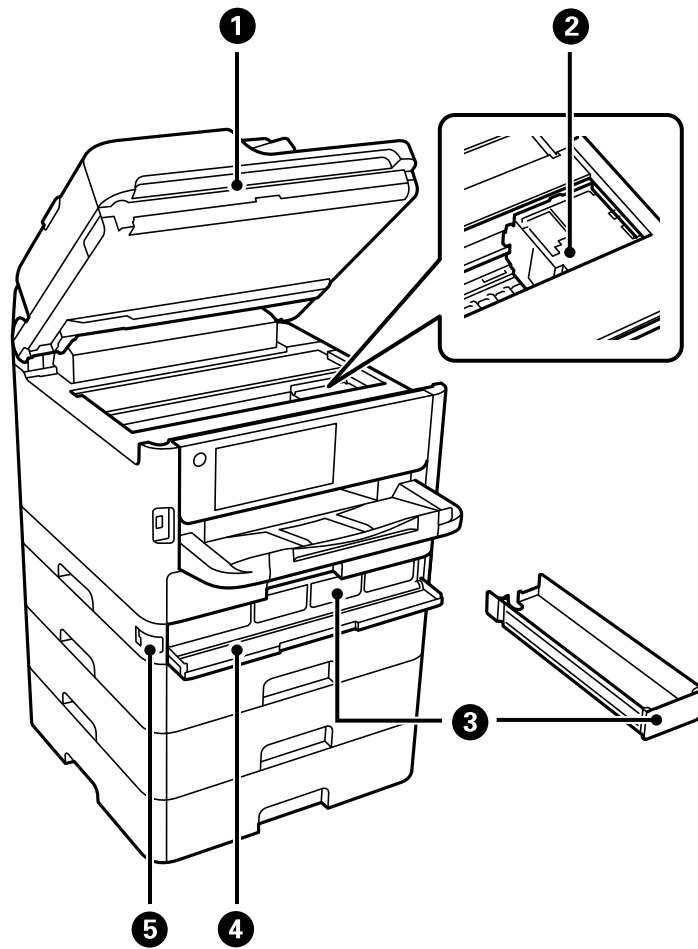

- 1 Scanner unit (J)
- 2 Print head
- 3 Ink tray
- 4 Ink cover (A)

5 Cover lock

Parent topic: [Product Parts Locations](#)

Product Parts - Back

Certain parts are labeled with a letter and number code. If you encounter any paper jams or errors, use these codes to locate and correct the problem.

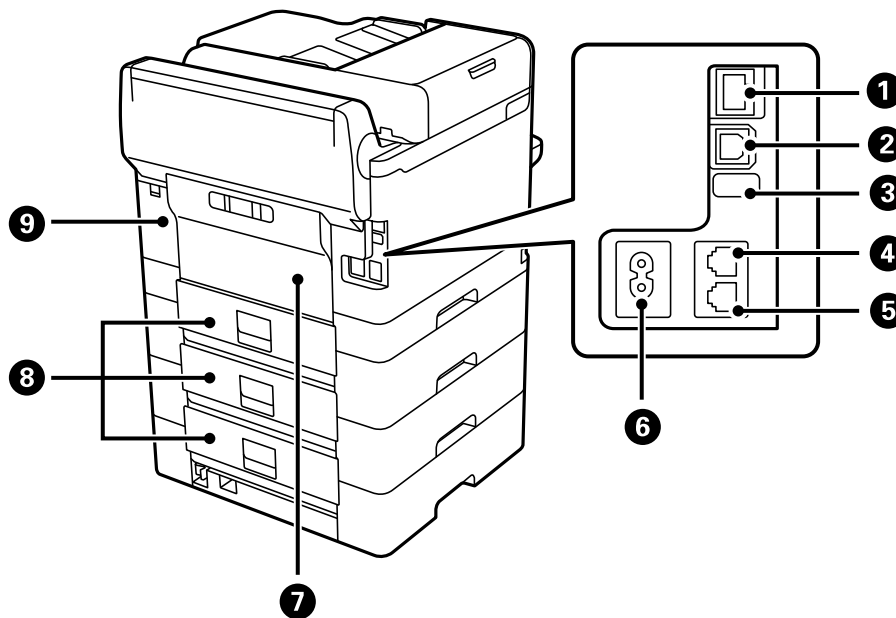

- 1 **LAN** port
- 2 **USB** port
- 3 Service USB port (do not remove sticker)
- 4 **LINE** port
- 5 **EXT.** port
- 6 AC inlet
- 7 Rear cover (D)

- 8 Rear cover (E)
- 9 Maintenance box cover (H)

Parent topic: [Product Parts Locations](#)

Using the Control Panel

See these sections to learn about the control panel and select control panel settings.

[Control Panel Buttons and Lights](#)

[Selecting the Date and Time](#)

[Selecting Your Country or Region](#)

[Entering Characters on the LCD Screen](#)

[Using Presets](#)

[Changing LCD Screen Language](#)

[Adjusting Control Panel Sounds](#)









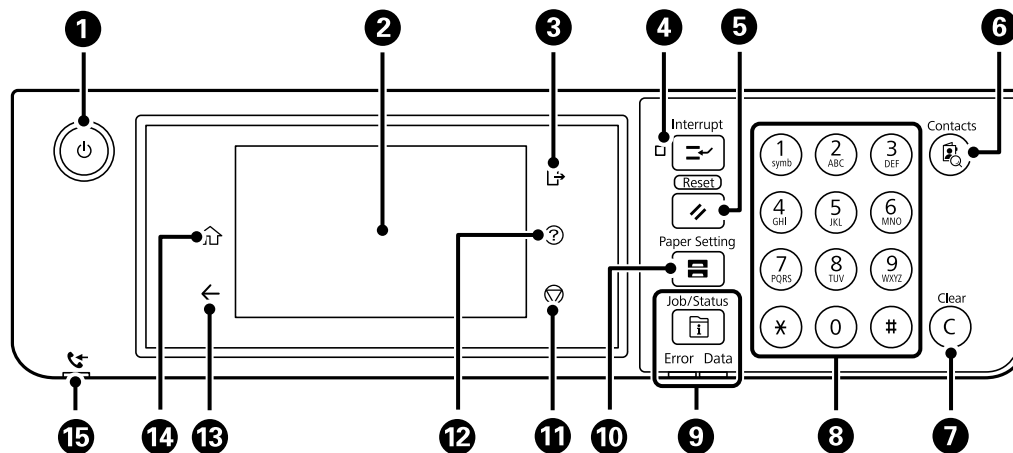



[Adjusting the Screen Brightness](#)

[Turning Off the Operation Time Out Setting](#)

Parent topic: [Product Basics](#)

Control Panel Buttons and Lights







- 1 The  power button and light
- 2 The LCD screen
- 3 The  log out button
- 4 The  **Interrupt** button
- 5 The  **Reset** button
- 6 The  **Contacts** button
- 7 The **C** clear button
- 8 The numeric keypad
- 9 The  **Job/Status** button, the **Error** light, and the **Data** light
- 10 The  **Paper Setting** button
- 11 The  stop button
- 12 The  help button
- 13  back button
- 14 The  home button
- 15  **Received Fax** light













Status Icon Information

Parent topic: [Using the Control Panel](#)

Status Icon Information

Your product displays status icons on the LCD screen for certain product status conditions. Press the   icon to view or change the current network settings.

Icons	Description
	Displays additional information or instructions, such as loading paper or placing a document.
	Quiet Mode is enabled. Noise is reduced during printing, but the print speed may be reduced. Press this icon to change the settings.
	Quiet Mode is disabled. Press this icon to change the settings.

Icons	Description
	The Mute setting is enabled. The printer does not make any sound when you press buttons on the control panel.
	Displays the Fax Data Information screen.
	Press this icon to enable sleep mode and turn off the LCD screen.
	The indicated setting has changed.
	No Ethernet connection.
	An Ethernet connection is established.
	No Wi-Fi connection.
	A Wi-Fi network error has occurred or the product is searching for a connection.
	A Wi-Fi connection is established. The number of bars indicates the connection's signal strength.
	No Wi-Fi Direct connection.
	A Wi-Fi Direct connection is established.
	Access to the product's functions are restricted to authorized users. Press the icon to log in to the printer using a user name and password. Contact your administrator if you do not know the login information.
	Access to the product's functions are restricted to authorized users and a user is currently logged in. Press the icon to log out of the current user account.

Parent topic: [Control Panel Buttons and Lights](#)

Selecting the Date and Time

Before using your product, select the current date, time, and daylight saving phase in your area, and choose your preferred date and time format.

Note: This setting can be locked by an administrator. If you cannot access or change this setting, contact your administrator for assistance.

1. Press the  home button, if necessary.

2. Select **Settings > General Settings > Basic Settings > Date/Time Settings**.
3. Select **Daylight Saving Time**.
4. Select the setting that applies to your area:
 - **Winter**: it is winter or your region does not use Daylight Saving Time (DST)
 - **Summer**: it is spring or summer and your region uses Daylight Saving Time (DST)

Note: If your region uses Daylight Saving Time (DST), you must change this setting to match the season. When you change from **Winter** to **Summer**, your product automatically sets its clock ahead one hour. When you change from **Summer** to **Winter**, it sets its clock back one hour.

5. Select **Date/Time**.
6. Select the date format you want to use.
7. Use the numeric keypad to enter the current date and select **OK**.
8. Select the time format you want to use.
9. Use the numeric keypad to enter the current time and select **OK**.

Parent topic: [Using the Control Panel](#)

Selecting Your Country or Region

Before using your product, select the country or region in which you are using your product.

Note: If you change the country or region, your fax settings return to their defaults and you must select them again. This setting can be locked by an administrator. If you cannot access or change this setting, contact your administrator for assistance.



1. Press the  home button, if necessary.
2. Select **Settings > General Settings > Basic Settings > Country/Region**.
3. Scroll up or down, if necessary, and select your country or region.
You see a confirmation screen.
4. If the setting is correct, select **Yes**. (If not, select **No** and retry.)

Parent topic: [Using the Control Panel](#)

Entering Characters on the LCD Screen

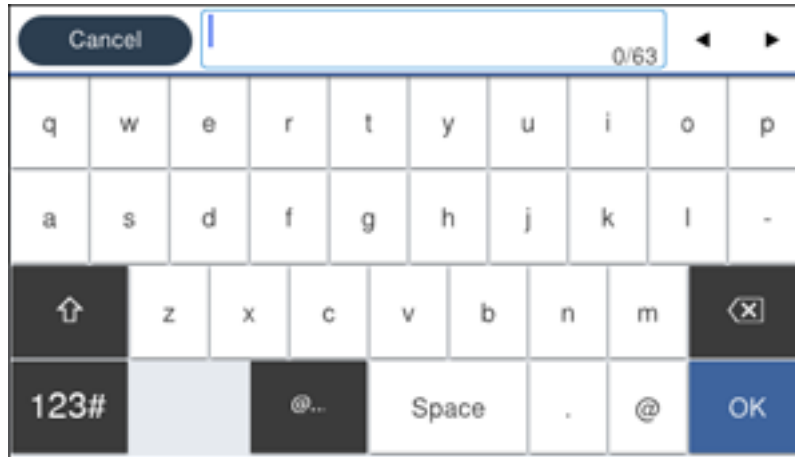
Follow these guidelines to enter characters for passwords and other settings.



- To move the cursor, select the left or right arrows.
- To change the case of letters, select .
- To delete the previous character, select .
- To enter numbers or symbols, select .
- To enter a space, select **Space**.

Parent topic: [Using the Control Panel](#)

Using Presets

You can save frequently used copy, fax, and scan settings as presets. This lets you easily reuse them whenever necessary.

Note: Presets can be locked by an administrator. If you cannot access or change presets, contact your administrator for assistance.

1. Press the  home button, if necessary.
2. Select **Presets**.
3. Select **Add New**. Enter the administrator password, if necessary.

Note: You can save up to 50 presets.

4. Select the function for which you want to set up a preset.
5. Select the settings you want to save and select **Register**.
6. Select **Name**.
7. Use the displayed keyboard to enter a name for the preset and select **OK**.
8. Select **OK** to return to the **Presets** screen.

When you copy, fax, or scan, you can use the preset by selecting **Presets** and selecting your preset name from the list.

Parent topic: [Using the Control Panel](#)

Changing LCD Screen Language

You can change the language used on the LCD screen.

Note: This setting can be locked by an administrator. If you cannot access or change this setting, contact your administrator for assistance.

1. Press the  home button, if necessary.
2. Select **Settings** > **General Settings** > **Basic Settings** > **Language**.
3. Select a language.

Parent topic: [Using the Control Panel](#)

Adjusting Control Panel Sounds



You can adjust the sound level heard when you press buttons on the control panel.

Note: This setting can be locked by an administrator. If you cannot access or change this setting, contact your administrator for assistance.

1. Press the  home button, if necessary.

2. Select **Settings** > **General Settings** > **Basic Settings** > **Sounds**.
3. Select **Mute** to turn off all control panel sounds, then go to step 7.
4. Select **Normal Mode** or **Quiet Mode** to adjust control panel sounds.

Note: You can also select the  icon on the home screen to adjust sounds.

5. Select **Button Press**.
6. Select  to decrease or  to increase the sound and select **OK** when you are finished.
7. Select the back arrow to exit.

Note: You can also adjust the **Sound Type** and the sound level for various product functions.

Parent topic: [Using the Control Panel](#)

Adjusting the Screen Brightness

You can adjust the brightness of the LCD screen.

1. Press the  home button, if necessary.
2. Select **Settings** > **General Settings** > **Basic Settings** > **LCD Brightness**.
3. Select the **-** or **+** icons to decrease or increase the brightness.
4. Select **OK** to exit.

Parent topic: [Using the Control Panel](#)

Turning Off the Operation Time Out Setting

The Operation Time Out setting causes the LCD screen to return to the Home screen after a few minutes of inactivity. This feature is enabled by default, but you can turn it off.

Note: This setting can be locked by an administrator. If you cannot access or change this setting, contact your administrator for assistance.

1. Press the  home button, if necessary.
2. Select **Settings** > **General Settings** > **Basic Settings**.
3. Scroll down and set **Operation Time Out** to **Off**.



Parent topic: [Using the Control Panel](#)

Checking for Software Updates

It's a good idea to check Epson's support website occasionally for free updates to your product software. Visit epson.com/support (U.S.), epson.ca/support (Canada), or latin.epson.com/support (Latin America) and select your product.

Note: Your printer is designed to work only with genuine Epson-brand ink packs. Other brands of ink packs and ink supplies are not compatible and, even if described as compatible, may not function properly or at all. Epson periodically provides firmware updates to address issues of security, performance, minor bug fixes and ensure the printer functions as designed. These updates may affect the functionality of third-party ink. Non-Epson branded or altered Epson ink packs that functioned prior to a firmware update may not continue to function.

- **Windows:** Your printer software automatically checks for updates. You can also manually update the software by selecting **Software Update** here:

- Accessing the Windows Desktop and right-clicking the  icon for your product in the right side of the Windows taskbar, or clicking the up arrow and right-clicking .
- On the **Maintenance** tab in the printer settings window

You can also update the software by selecting **EPSON Software Updater** in the **EPSON** or **Epson Software** program group, accessible by the **Start** button, or on the **Start** or **Apps** screens, depending on your version of Windows.

- **OS X:** You can manually update the software by opening the **Applications > Epson Software** folder and selecting **EPSON Software Updater**.
- **macOS 10.12.x to 13.x:** You can manually update the software by opening the **App Store**, selecting **Updates**, searching for a software update option for Epson Software, and selecting **Update**.

Parent topic: [Product Basics](#)

Using Power Saving Settings

Your product enters sleep mode automatically and turns off the LCD screen if it is not used for a period of time. You can make the time period shorter and select other options to save energy and resources.

[Changing the Sleep Timer Settings](#)

[Changing the Power Off Timer Settings](#)

Parent topic: [Product Basics](#)

Changing the Sleep Timer Settings

You can adjust the time period before your product enters sleep mode and turns off the LCD screen.

Note: This setting can be locked by an administrator. If you cannot access or change this setting, contact your administrator for assistance.

1. Press the  home button, if necessary.
2. Select **Settings** > **General Settings** > **Basic Settings** > **Sleep Timer**.

Note: Enter the administrator password, if necessary.

3. Do one of the following:
 - Select the **–** or **+** icon to decrease or increase the number of minutes.
 - Select the number of minutes on the LCD screen, select the number of minutes from the on-screen keypad, and select **OK**.
4. Select **OK**.
5. Select **Wake from Sleep**.
6. Select **Touch LCD Screen to Wake**.
7. Do one of the following:
 - Select **On** to wake the printer from sleep mode by tapping the LCD touchscreen or by pressing a button on the control panel.
 - Select **Off** to wake the printer from sleep mode by only pressing a button on the control panel. This prevents unintentional operations due to objects bumping the LCD touchscreen.
 - Select **Scheduled** to set a time range for the feature to be enabled.

Parent topic: [Using Power Saving Settings](#)

Related tasks

[Adjusting Power Saving Settings](#)

Changing the Power Off Timer Settings

You can have the product turn off automatically if it is not used for a specified period of time.

Note: This setting can be locked by an administrator. If you cannot access or change this setting, contact your administrator for assistance.

1. Press the  home button, if necessary.
2. Select **Settings** > **General Settings** > **Basic Settings** > **Power Off Timer**.
3. Select a time period between **30minutes** and **12h** (12 hours).

Parent topic: [Using Power Saving Settings](#)

Related tasks

[Adjusting Power Saving Settings](#)

Epson Connect Solutions for Smartphones, Tablets, and More

Use your smartphone, tablet, or computer to print and scan documents, photos, emails, and web pages from your home, office, or even across the globe.

Note: If you are using your Epson product with the Windows 10 S operating system, you cannot use the software described in this section. You also cannot download and install any Epson product software from the Epson website for use with Windows 10 S; you must obtain software only from the Windows Store.

Print from anywhere with these Epson Connect solutions:

- Epson Email Print
- Epson Remote Print

Scan and send a file as an email or upload it to an online service directly from your Epson product with Epson Scan to Cloud.

[Setting Up Epson Connect Services](#)

[Using Epson Email Print](#)

[Using Epson Remote Print](#)

[Using Epson Scan to Cloud](#)

Parent topic: [Product Basics](#)

Setting Up Epson Connect Services

If you did not activate your product's email address for use with Epson Connect when you set up your product, you can activate it using the product control panel.

1. Press the  home button, if necessary.
2. Select **Settings** > **General Settings** > **Web Service Settings** > **Epson Connect Services**.

3. Select **Register**.
4. Follow the instructions on the screen to activate your product's email address.

Parent topic: [Epson Connect Solutions for Smartphones, Tablets, and More](#)

Using Epson Email Print

With Epson Email Print, you can print from any device that can send email, such as your smartphone, tablet, or laptop. Just activate your product's unique email address. When you want to print, attach a PDF, Microsoft Office document, or photo to an email and send it to your product. Both the email and the attachments will print automatically.

1. Connect your product to your network. See the link below.
2. If you did not already set up Email Print when you installed your product software, see the link below to use your product control panel to activate your unique email address. Or visit epson.com/connect (U.S.), epson.ca/connect (Canada), or latin.epson.com/connect (Latin America) to learn more about Email Print, create your Epson Connect account, and register your product to the Epson Connect service.
3. Now you are ready to send and print emails to your product's Email Print address.

Note: Go to epsonconnect.com and log into your Epson Connect account to personalize your product's email, adjust print settings, and set up other Epson Connect services.

Parent topic: [Epson Connect Solutions for Smartphones, Tablets, and More](#)

Related tasks

[Setting Up Epson Connect Services](#)

Related topics

[Wi-Fi or Wired Networking](#)

Using Epson Remote Print

With Epson Remote Print software, you can print from your laptop or desktop computer to an Epson Email-enabled product anywhere in the world.

1. Connect your Epson product to your wireless network. See the link below.

2. If you did not already set up an Epson Connect account when you installed your product software, visit epsonconnect.com to create your account and register your product to the Epson Connect service.

Note: Make a note of your product's email address.

3. Visit epsonconnect.com to learn more about Remote Print and how to download the Remote Print Driver software.
4. Download and install the Remote Print software.
5. Enter the email address and optional access key of your Epson product during Remote Print setup.
6. Now you are ready to print remotely. Select the print command in your laptop or desktop computer application and choose the Remote Print option for your Epson product.

Parent topic: [Epson Connect Solutions for Smartphones, Tablets, and More](#)

Related tasks

[Setting Up Epson Connect Services](#)

Related topics

[Wi-Fi or Wired Networking](#)

Using Epson Scan to Cloud

The Epson Scan to Cloud service allows you to scan and send a file as an email or upload it to an online service directly from your Epson product. Register an email address or online services such as Box, DropBox, Evernote, or Google Drive with your Epson Connect account.

1. Connect your Epson product to your network. See the link below.
2. If you did not already set up an Epson Connect account when you installed your product software, visit epsonconnect.com to create your account and register your product to the Epson Connect service.

Note: Make a note of your product's email address and password.

3. Visit epsonconnect.com to sign into your account with the email address and password you selected.
4. Select your product, select **Scan to Cloud**, and select **Destination List**.
5. Click **Add**, then follow the instructions on the screen to create your destination list.

6. Now you are ready to use Scan to Cloud. Select the setting for scanning to Scan to Cloud on your Epson product control panel.

Parent topic: [Epson Connect Solutions for Smartphones, Tablets, and More](#)

Related tasks

[Setting Up Epson Connect Services](#)

Related topics

[Wi-Fi or Wired Networking](#)

Using the Epson Smart Panel Mobile App

Use this free Apple and Android app to set up and control your Epson product. Epson Smart Panel also lets you check product status.

Note: App features may vary depending on your Epson product.

1. Visit epson.com/connect (U.S.), epson.ca/connect (Canada), or latin.epson.com/connect (Latin America) to learn more about Epson Smart Panel and check the compatibility of your mobile device.
2. Download Epson Smart Panel from the Apple App Store or Google Play.
3. Do one of the following:
 - If your Epson product is already connected to a wireless network, connect your mobile device to the same network. Then open Epson Smart Panel and select your Epson product, if necessary.
 - If your Epson product is not connected to a wireless network, connect your mobile device to the network you want to use, then open Epson Smart Panel and follow the instructions to set up your Epson product.

Now you are ready to control your Epson product with your mobile device.

Parent topic: [Product Basics](#)

Related topics

[Wi-Fi or Wired Networking](#)

Using AirPrint

AirPrint enables instant wireless printing from iPhone, iPad, iPod touch, and Mac without the need to install drivers or download software.



Note: If you disabled paper configuration messages on your product control panel, you cannot use AirPrint. See the link below to enable the messages, if necessary.

1. Load paper in your product.
2. Set up your product for wireless printing. See the link below.
3. Connect your Apple device to the same wireless network that your product is using.
4. Print from your device to your product.

Note: For details, see the AirPrint page on the Apple website.

Parent topic: [Product Basics](#)

Related references

[Paper Source Settings Options](#)

Related topics

[Wi-Fi or Wired Networking](#)

Setting Up Printing on a Chromebook

Your Epson printer supports native printing on Chromebook, allowing you to print from a Chromebook without drivers or cables.

For directions on setting up your printer, visit [Setting Up Your Epson Printer on Your Chromebook \(U.S.\)](#) or [Setting Up Your Epson Printer on Your Chromebook \(Canada\)](#).

For Latin America, visit [Setting Up Your Epson Printer on Your Chromebook](#).

Parent topic: [Product Basics](#)

[Printing from a Computer](#)

Related topics

[Wi-Fi or Wired Networking](#)

Android Printing Using the Epson Print Enabler

You can wirelessly print your documents, emails, photos, and web pages right from your Android phone or tablet (Android v4.4 or later). With a few taps, your Android device will discover your nearby Epson product and print.

1. Connect your Epson product to your wireless network. See the link below.
2. On your Android device, download the Epson Print Enabler plug-in from Google Play.
3. Go to **Settings** on your Android device, select **Printing**, and enable the Epson plug-in, if necessary.
4. Connect your Android device to the same wireless network as your product.
5. Now you are ready to print. From an Android application such as Chrome or Gmail, tap the menu icon and print whatever is on the screen.

Note: If you do not see your product, tap **All Printers** and select your product.

Parent topic: [Product Basics](#)

Related topics

[Wi-Fi or Wired Networking](#)

Using the Mopria Print Service

You can use the Mopria Print Service to print from your Android phone or tablet (Android v4.4 or later) to your Epson product or any Mopria-certified product from other manufacturers. You can download the Mopria Print Service from Google Play.

Note: For details on the Mopria Print Service, [click here](#) (U.S.) or [click here](#) (Canada). Some Amazon Fire tablets also use the Mopria Print Service.

1. Connect your Epson product to your wireless network. See the link below.
2. On your Android device, download the Mopria Print Service app from Google Play.

Note: On some Samsung Galaxy devices, Mopria may come preinstalled.

3. Go to **Settings** on your Android device, select **Printing**, and enable the Mopria Print Service, if necessary.
4. Connect your Android device to the same wireless network as your product.
5. Now you are ready to print. From an Android application such as Chrome or Gmail, tap the menu icon and select **Print**. Then select **All printers**, select your Epson product, adjust your print settings, and print.

Parent topic: [Product Basics](#)

Related topics

[Wi-Fi or Wired Networking](#)

Voice-activated Printing

Take advantage of voice-activated, hands-free printing from your Epson product with Alexa and Siri. Depending on which voice assistant you use, you can ask your product to print photos, calendars, recipes, photo props, and more. [Click here](#) for more information.

1. Connect your product to your network. See the link below.
2. Set up your product's email address for use with Epson Connect. See the link below to activate it from the product control panel.
3. [Click here](#) for instructions on how to set up your product and voice assistant to use the voice-activated printing feature.

Now you are ready to print with your voice and your Epson product.

Parent topic: [Product Basics](#)

Related tasks

[Setting Up Epson Connect Services](#)

Related topics

[Wi-Fi or Wired Networking](#)

Wi-Fi or Wired Networking

See these sections to use your product on a Wi-Fi or wired network.

[Network Security Recommendations](#)

[Wi-Fi Infrastructure Mode Setup](#)

[Wi-Fi Direct Mode Setup](#)

[Wi-Fi Protected Setup \(WPS\)](#)

[Printing a Network Status Sheet](#)

[Printing a Network Connection Report](#)

[Configuring Email Server Settings](#)

[Changing or Updating Network Connections](#)

Network Security Recommendations

To help deter unauthorized access to your product over a network, you should protect your network environment using appropriate security measures.

Security measures such as these can help deter threats such as loss of user data, use of telephone and fax lines, and other intrusions:

- **Enable security on your wireless LAN**

Enable the appropriate security on the wireless LAN you plan to use with your product. Network security such as a network password can deter interception of traffic over the wireless LAN. Your router may already have a default password enabled by your Internet service provider (ISP). See your ISP and router documentation for instructions on how to change the default password and better secure your network.

- **Connect your product only to a network protected by a firewall**

Connecting your product directly to the Internet may leave it vulnerable to security threats. Instead, connect it to a router or other network connection protected by a firewall. Your router may already have a firewall set up by your Internet service provider; check with your ISP for confirmation. For best results, set up and use a private IP address for your network connection.

- **Change the default administrator password on your product**

If your product has an option to set an administrator password, change the default administrator password to deter access by unauthorized users to personal data stored on your product, such as IDs, passwords, and contact lists.

Parent topic: [Wi-Fi or Wired Networking](#)

Wi-Fi Infrastructure Mode Setup

You can set up your product to communicate with your computer using a wireless router or access point. The wireless router or access point can be connected to your computer over a wireless or wired network.

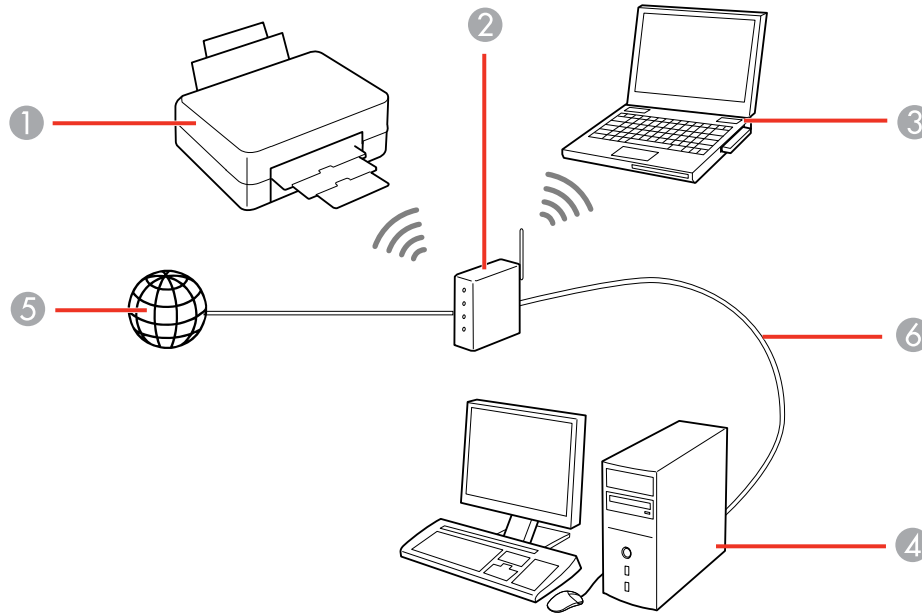

- 1 Epson product
- 2 Wireless router or access point
- 3 Computer with a wireless interface
- 4 Computer
- 5 Internet
- 6 Ethernet cable (used only for wired connection to the wireless router or access point)

[Selecting Wireless Network Settings from the Control Panel](#)



Parent topic: [Wi-Fi or Wired Networking](#)

Selecting Wireless Network Settings from the Control Panel

You can select or change wireless network settings using your product control panel.



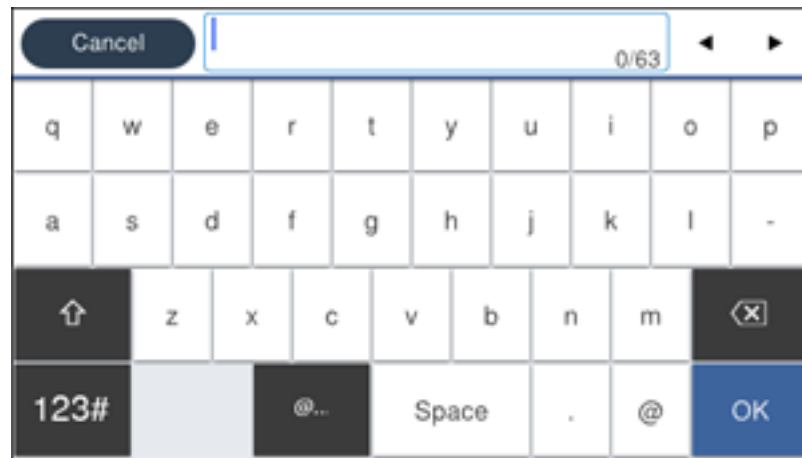

To install your product on a wireless network, follow the instructions on the *Start Here* sheet and install the necessary software by downloading it from the Epson website. The installer program guides you through network setup.

Note: Breakdown or repair of this product may cause loss of fax and network data and settings. Epson is not responsible for backing up or recovering data and settings during or after the warranty period. We recommend that you make your own backup or print out your fax and network data and settings.

1. Press the  home button, if necessary.
2. Press the   icon.
3. Select **Router**.
4. Select **Start Setup**, **Change Settings**, or **Change to Wi-Fi Connection**.
5. Select **Wi-Fi Setup Wizard**.
6. Select the name of your wireless network or select **Enter Manually** to enter the name manually. Use the displayed keypad to enter your network name.
7. Select the **Enter Password** field and enter your wireless password using the displayed keypad.



Note: The network name and password are case sensitive. Be sure to correctly enter uppercase and lowercase letters, and numeric or special characters.

- To move the cursor, select the left or right arrows.
 - To change the case of letters, select .
 - To delete the previous character, select .
 - To enter numbers and symbols, select .
 - To enter a space, select **Space**.
8. Select **OK** when you finish entering your password.
 9. Confirm the displayed network settings and select **Start Setup** to save them.
A message appears when setup is complete.
 10. Press the  home button to exit.

You see the  icon on the LCD screen and should be able to connect to your product directly from your computer or device, and then print. If you are printing from a computer, make sure you installed the network software as described on the *Start Here* sheet.

Note: If you don't see the  icon, you may have selected the wrong network name or entered the password incorrectly. Repeat these steps to try again.

Parent topic: [Wi-Fi Infrastructure Mode Setup](#)

Related references

[Status Icon Information](#)

Related tasks

[Entering Characters on the LCD Screen](#)

Wi-Fi Direct Mode Setup

You can set up your product to communicate directly with your computer or another device without requiring a wireless router or access point. In Wi-Fi Direct Mode, the product itself acts as a network access point for up to 8 devices.

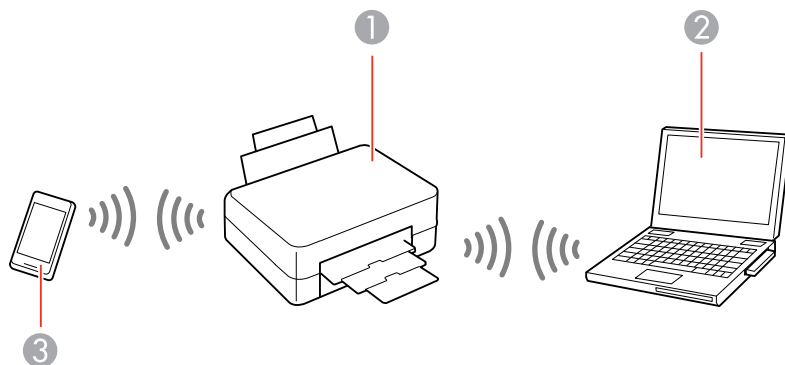

- 1 Epson product
- 2 Computer with a wireless interface
- 3 Other wireless device

Note: The product normally uses W52 (36ch) as the channel when connecting to Wi-Fi Direct (Simple AP). Since the channel for wireless LAN (Wi-Fi) connection is selected automatically, the channel used may differ when used at the same time as a Wi-Fi Direct connection. Sending data to the printer may be delayed if the channels are different. If it does not interfere with use, connect to the SSID in the 2.4 GHz band. In the 2.4 GHz frequency band, the channels used will match.

When setting the wireless LAN to 5 GHz, we recommend disabling Wi-Fi Direct.

[Connecting to a Mobile Device](#)



[Modifying the Wi-Fi Direct Network Name or Password](#)

Parent topic: [Wi-Fi or Wired Networking](#)

Connecting to a Mobile Device

You can connect a mobile device directly to the printer without a wireless router or access point.

Note: Make sure the Epson Smart Panel app is installed on your mobile device before connecting to the printer.

1. Press the  home button, if necessary.
2. Select the  icon.
3. Select **Wi-Fi Direct**.
4. Select **Start Setup**.
5. Do one of the following:
 - If you are using Epson Smart Panel, open the Epson Smart Panel app on your device and select the printer displayed on the LCD screen. Select **Complete** on the LCD screen.
 - For iOS devices, select **Other Methods**, then select **iOS**. Scan the QR code with the camera app on your device and follow the instructions on your device. On the printer LCD screen, select **Complete**.
 - For other types of devices, select **Other Methods**, then select **Other OS Devices**. Use your device to select the Wi-Fi network name (SSID) displayed on the LCD screen, then enter the password shown.
6. Follow the instructions on the LCD screen to complete Wi-Fi Direct setup.

The  Wi-Fi Direct icon displayed on the LCD screen indicates if Wi-Fi Direct is enabled on the product.

If you are printing from a computer, make sure you installed the network software as described on the *Start Here* sheet.

Parent topic: [Wi-Fi Direct Mode Setup](#)

Related references

[Status Icon Information](#)



Related tasks

[Entering Characters on the LCD Screen](#)

Modifying the Wi-Fi Direct Network Name or Password

You can modify the Wi-Fi Direct name and password to create a more descriptive and secure Wi-Fi Direct network.

Note: If you are printing from a computer, make sure you installed the network software as described on the *Start Here* sheet.

1. Press the  home button, if necessary.
2. Select the  icon.
3. Select **Wi-Fi Direct**.
4. Select **Start Setup**.
5. Select the **Menu** icon.
6. Do one of the following:
 - To change the Wi-Fi Direct network name, select **Change Network Name**, and select **Yes**. Select **Change**, then use the on-screen keyboard to enter the new network name.
 - To change the Wi-Fi Direct password, select **Change Password**, then select **Yes**. Use the on-screen keyboard to enter your new Wi-Fi Direct password.

Note: Your password must be at least 8 and no more than 22 characters long.

Note: If you have already connected devices or computers to your product via Wi-Fi Direct, they will be disconnected when you change the network name or password.

7. When entering your Wi-Fi Direct network name or password, do the following:
 - To enter letters or symbols, tap them on the LCD screen.
 - To enter numbers and symbols or change the case of letters, select the **123#** icon.
 - To delete the previous character, select the  back icon.
 - To enter a space, select **Space**.
8. Use your computer or wireless device to select the Wi-Fi network name (SSID) displayed on the LCD screen, then enter the password shown.

Note: Make a note of the SSID and password that appear.

9. Press the  home button to return to the home screen.
Computers and wireless devices can now access the product using the new network name and password.

Parent topic: [Wi-Fi Direct Mode Setup](#)

Wi-Fi Protected Setup (WPS)

If your network uses a WPS-enabled wireless router or access point, you can quickly connect your product to the network using Wi-Fi Protected Setup (WPS).



Note: To check if your router is WPS-enabled, look for a button labeled **WPS** on your router or access point. If there is no hardware button, there may be a virtual WPS button in the software for the device. Check your network product documentation for details.

[Using WPS to Connect to a Network](#)

Parent topic: [Wi-Fi or Wired Networking](#)

Using WPS to Connect to a Network

If you have a WPS-enabled wireless router or access point, you can use Wi-Fi Protected Setup (WPS) to connect your product to the network.

1. Press the  home button, if necessary.
2. Press the   icon.

You see a screen like this:

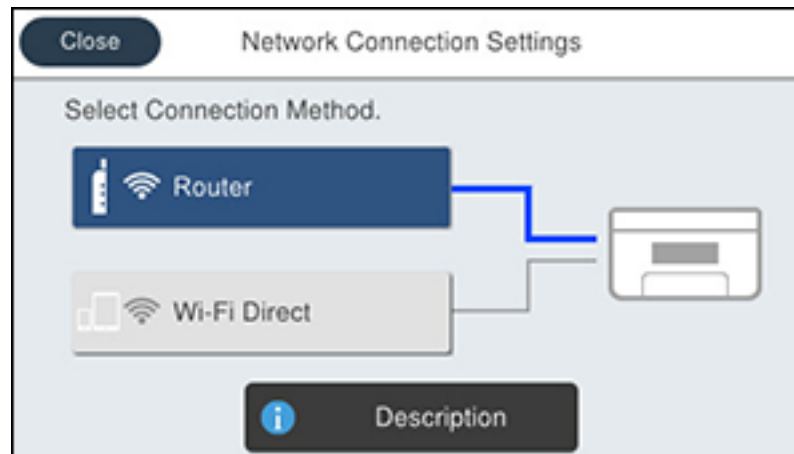

3. Select **Router**.
4. Select **Change Settings**, if necessary.
5. Select **Push Button Setup (WPS)**.
6. Follow the instructions on the LCD screen to complete WPS setup.
7. Press the  home button to exit.

You see the  icon on the LCD screen and should be able to connect to your product directly from your computer or device, and then print. If you are printing from a computer, make sure you installed the network software as described on the *Start Here* sheet.

Note: If you don't see the  icon, repeat these steps to try again.

Parent topic: [Wi-Fi Protected Setup \(WPS\)](#)

Printing a Network Status Sheet

You can print a network status sheet to help you determine the causes of any problems you may have using your product on a network.

1. Press the  home button, if necessary.
2. Select **Settings > General Settings > Network Settings > Network Status > Print Status Sheet**.
3. Select **Print**.

Examine the settings shown on the network status sheet to diagnose any problems you have.

Parent topic: [Wi-Fi or Wired Networking](#)

Printing a Network Connection Report

You can print a network connection report to view solutions to any problems you may have using your product on a network.

1. Press the  home button, if necessary.
2. Select **Settings > General Settings > Network Settings > Connection Check**.
3. Select **Print Check Report**.

Note: Select **OK** to return to the **Network Settings** menu without printing a report.

4. Select **Print**.

Examine the error codes and solutions shown on the network connection report.

[Network Connection Report Codes and Messages](#)

Parent topic: [Wi-Fi or Wired Networking](#)

Network Connection Report Codes and Messages

Check the error codes and messages on the network connection report to solve problems you may encounter with network connections. The tables here list solutions to problems based on the error codes and messages that may appear on the top of the report.

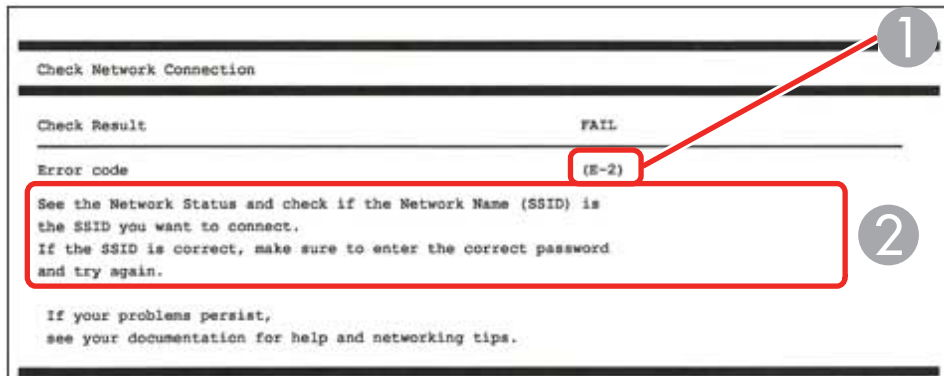

1 Error code

2 Message

Note: Error codes and messages listed here may not all apply to your product.

Error Codes and Messages

Error code and message	Solution
E-1 Confirm that the network cable is connected and network devices such as hub, router, or access point are turned on.	Make sure your router, access point, and/or hub are turned on, and the network cable is securely connected to your device and to your product. If you are trying to set up Wi-Fi, remove the network cable and set up Wi-Fi again. Ethernet and Wi-Fi cannot be connected at the same time.

Error code and message	Solution
<p>E-2, E-3, or E-7</p> <p>No wireless network names (SSID) found. Confirm that the router/access point is turned on and the wireless network (SSID) is set up correctly. Contact your network administrator for assistance.</p> <p>No wireless network names (SSID) found. Confirm that the wireless network name (SSID) of the PC you wish to connect is set up correctly. Contact your network administrator for assistance.</p> <p>Entered security key/password does not match the one set for your router/access point. Confirm security key/password. Contact your network administrator for assistance.</p>	<p>Check the following:</p> <ul style="list-style-type: none"> • Make sure your router or access point is turned on, and is correctly connected to your computer or network device. • Turn off the router or access point, wait about 10 seconds, and turn it on again. • Move your product closer to your router or access point, and remove any obstacles between them. Also move your product away from devices such as wireless phones or microwaves. • Confirm that the SSID shown on the network connection report matches the label on your router or access point. Also make sure your SSID uses only ASCII characters and symbols, or your product cannot display the SSID correctly. • If you are trying to connect using the WPS push button method, make sure your router or access point supports it. • If you are using a network password, check the label on your router or access point to confirm that you are using the correct password, or check with your network administrator or router/access point documentation. • If you are connecting to a smart device that generates an SSID, check the device documentation for the SSID and password you should use. • If your wireless connection suddenly disconnects, and another smart device was added to the network using a WPS push button method or your network was set up using a non-WPS push button method, try downloading and installing your product software again.

Error code and message	Solution
<p>E-5 Security mode (e.g. WEP, WPA) does not match the current setting of the printer. Confirm security mode. Contact your network administrator for assistance.</p>	<p>If the security on your router or access point is not one of the following types, change the type of security on your router or access point and reset your product's network settings.</p>
<p>E-6 MAC address of your printer may be filtered. Check whether your router/access point has restrictions such as MAC address filtering. See the documentation of the router/access point or contact your network administrator for assistance.</p>	<p>If your router or access point has MAC address filtering enabled, register your product's MAC address so it is not filtered. Locate the MAC address on the network connection report and check your router or access point documentation for instructions.</p> <p>If your router or access point is using shared authentication with WEP security, confirm that you are using the correct authentication key and index.</p> <p>If your router or access point limits the number of connected devices, raise the connection limit. See your router or access point documentation for instructions.</p>
<p>E-8 Incorrect IP address is assigned to the printer. Confirm IP address setup of the network device (hub, router, or access point). Contact your network administrator for assistance.</p>	<p>If your product's Obtain IP Address setting is set to Auto, enable DHCP on your router or access point. If it is set to Manual, the IP address may be out of range or on a different network segment; set a valid IP address using your product control panel or the Web Config utility.</p> <p>You can also try turning off your product and the router or access point, waiting about 10 seconds, and turning them on again.</p>
<p>E-9 Confirm the connection and network setup of the PC or other device. Connection using the EpsonNet Setup is available. Contact your network administrator for assistance.</p>	<p>Make sure your computer or network device are turned on. Also make sure that you can access the Internet and other devices on the same network from the devices you are trying to connect to your product.</p> <p>If you still cannot connect to your product, turn off your router or access point, wait about 10 seconds, and turn it on again. Download and install your product software again to reset your network settings.</p>

Error code and message	Solution
<p>E-10</p> <p>Confirm IP address, subnet mask, and default gateway setup. Connection using the EpsonNet Setup is available. Contact your network administrator for assistance.</p>	<p>Make sure other devices on the network are turned on and do the following:</p> <ul style="list-style-type: none"> • If your product's Obtain IP Address setting is set to Manual, check the IP address, subnet mask, and default gateway addresses on the network connection report to see if they are correct. If not, correct the settings. • If DHCP is enabled, set your product's Obtain IP Address setting to Auto. If you want to use the DHCP-assigned address as a static address, set the Obtain IP Address setting to Manual, enter the product's IP address as listed on the network connection report, and set the subnet mask to 255.255.255.0. <p>If you still cannot connect to your product, turn off your router or access point, wait about 10 seconds, and turn it on again.</p>
<p>E-11</p> <p>Setup is incomplete. Confirm default gateway setup. Connection using the EpsonNet Setup is available. Contact your network administrator for assistance.</p>	<p>If you set your product's TCP/IP Setup setting to Manual, check that the default gateway address listed on the network connection report is correct. Also turn on the device that is set as the default gateway.</p>

Error code and message	Solution
<p>E-12</p> <p>Confirm the following:</p> <ul style="list-style-type: none"> -Entered security key/password is correct -Index of the security key/password is set to the first number -IP address, subnet mask, or default gateway setup is correct <p>Contact your network administrator for assistance.</p>	<p>Make sure other devices on the network are turned on and do the following:</p> <ul style="list-style-type: none"> • Make sure the IP address, subnet mask, and default gateway addresses are correct, if you are entering them manually. • Confirm that the subnet mask and default gateway addresses for other devices are the same. • Make sure the IP address does not conflict with other devices. <p>If you still cannot connect to your product, do the following:</p> <ul style="list-style-type: none"> • Turn off your router or access point, wait about 10 seconds, and turn it on again. • Download and install your product software again to reset your network settings. • If your router or access point uses WEP security with several registered passwords, make sure that the first registered password is set on your product.
<p>E-13</p> <p>Confirm the following:</p> <ul style="list-style-type: none"> -Entered security key/password is correct -Index of the security key/password is set to the first number -Connection and network setup of the PC or other device is correct <p>Contact your network administrator for assistance.</p>	<p>Make sure your router, access point, and/or hub are turned on. Also make sure the TCP/IP setup on your router, access point, and/or hub is not set manually; this may cause your product's network settings to differ from the manually set up devices.</p> <p>If you still cannot connect to your product, do the following:</p> <ul style="list-style-type: none"> • Turn off your router or access point, wait about 10 seconds, and turn it on again. • Download and install your product software again to reset your network settings. • If your router or access point uses WEP security with several registered passwords, make sure that the first registered password is set on your product.

Network Environment Messages

Message	Solution
The Wi-Fi environment needs to be improved. Turn the wireless router off and then turn it on. If the connection does not improve, see the documentation for the wireless router.	Move your product closer to your router or access point, and remove any obstacles between them. Then turn off your router or access point, wait about 10 seconds, and turn it back on again. If you still cannot connect to your product, check the documentation that came with your router or access point for solutions.
*No more devices can be connected. Disconnect one of the connected devices if you want to add another one.	You can connect up to 8 computers or other devices to your product using a Wi-Fi Direct (Simple AP) connection. If you want to add another device, disconnect an existing connected device first.
The same SSID as Wi-Fi Direct exists in the environment. Change the Wi-Fi Direct SSID if you cannot connect a smart device to the printer.	Change the Wi-Fi Direct SSID.

Parent topic: [Printing a Network Connection Report](#)

Configuring Email Server Settings

To use features such as scanning to email or forwarding faxes to email, you need to configure the email server. You can select settings for the email server using the control panel on the product.

Note: These settings can be locked by an administrator. If you cannot access these settings, contact your administrator for assistance.

1. Press the  home button, if necessary.
2. Select **Settings** > **General Settings** > **Network Settings** > **Advanced** > **Email Server** > **Server Settings**.
3. Select one of the options, then select the settings you want to use. Contact your internet service provider if necessary to confirm the authentication method for the email server.
4. Select **Proceed** to save your settings.
5. Select **Close** to exit.
6. Select **Connection Check** to verify the connection to the email server.

Email Server Settings

Parent topic: [Wi-Fi or Wired Networking](#)

Email Server Settings

Setting name	Available options	Description
Authentication Method	Off SMTP AUTH POP before SMTP	Selects the authentication method for the printer to access the mail server. SMTP AUTH: Authenticates on the SMTP server (outgoing mail server) when sending the email. The mail server needs to support SMTP authentication. POP before SMTP Authenticates on the POP3 server (receiving mail server) before sending the email. When you select this item, set the POP3 server.
Authenticated Account	—	Lets you enter a user name or email address for the mail server. Used with the POP before SMTP and SMTP AUTH methods.
Authenticated Password	—	Lets you enter a password for the authenticated account. Used with the POP before SMTP and SMTP AUTH methods.
Sender's Email Address	—	Lets you enter the email address to be displayed to the sender
SMTP Server Address	—	Lets you enter the address of the SMTP server
SMTP Server Port Number	—	Lets you enter the port number of the SMTP server. The default port is 25.
Secure Connection	None STARTTLS SSL/TLS	Selects the encryption protocol used by the email server. Used with the SMTP AUTH or Off authentication methods.
Certificate Validation	Enable Disable	Determines whether the CA Certificate is validated. You must import a CA certificate to use this setting.

Setting name	Available options	Description
POP3 Server Address	—	Lets you enter the address of the POP3 server using IPv4 or FQDN format.
POP3 Server Port Number	—	Lets you enter the port number of the POP3 server. The default port is 25.

Parent topic: [Configuring Email Server Settings](#)

Changing or Updating Network Connections

See these sections to change or update how your product connects to a network.

[Changing a USB Connection to a Wi-Fi Connection](#)

[Changing a Wi-Fi Connection to a Wired Network Connection](#)

[Connecting to a New Wi-Fi Router](#)

[Disabling Wi-Fi Features](#)

Parent topic: [Wi-Fi or Wired Networking](#)

Changing a USB Connection to a Wi-Fi Connection

If you have already connected your product to your computer using a USB connection, you can change to a Wi-Fi connection.

1. Disconnect the USB cable from your product.
2. Uninstall your product software.
3. Download and install your product software from the Epson website using the instructions on the *Start Here* sheet.

Parent topic: [Changing or Updating Network Connections](#)

Related concepts

[Uninstall Your Product Software](#)

Changing a Wi-Fi Connection to a Wired Network Connection

If you have already connected your product to your computer wirelessly, you can change to a wired network connection if necessary.

1. Disable your product's Wi-Fi features.
2. Connect one end of an Ethernet network cable to the product's **LAN** port.

3. Connect the other end to any available LAN port on your router or access point.
4. Uninstall your product software.
5. Download and install your product software from the Epson website.
6. Follow the on-screen instructions to install the software.
7. When you see the Select Your Connection screen, select **Wired network connection**.
8. If you see a Select Setup Option screen, select **Set up printer for the first time**.
9. Continue following the rest of the on-screen instructions.

Parent topic: [Changing or Updating Network Connections](#)

Related concepts

[Uninstall Your Product Software](#)

Related tasks

[Disabling Wi-Fi Features](#)

Connecting to a New Wi-Fi Router

If you change the wireless router you have been using on your network, you need to update your product's Wi-Fi connection to the new router.

Note: If you switch to a 5 GHz wireless router, set the router to operate in dual band (2.4 GHz and 5 GHz) mode. If your router uses a single network name (SSID) for both the 2.4 GHz and 5 GHz band, give each band its own network name (SSID) instead, such as Home Network 2.4 GHz and Home Network 5 GHz. See your router documentation for instructions.

1. Do one of the following:
 - **Windows:** Uninstall your product software.
 - **Mac:** Go to the next step.
2. Download and install your product software from the Epson website using the instructions on the *Start Here* sheet.

Parent topic: [Changing or Updating Network Connections](#)



Related concepts

[Uninstall Your Product Software](#)

Disabling Wi-Fi Features

You may need to disable your product's Wi-Fi features if you change your network connection type or need to solve a problem with your network connection.

Note: Before disabling Wi-Fi features, make a note of your product's SSID (network name) and password, and any network settings selected for the Epson Connect services you may use.

1. Press the  home button, if necessary.
2. Press the   icon.

You see a screen like this:

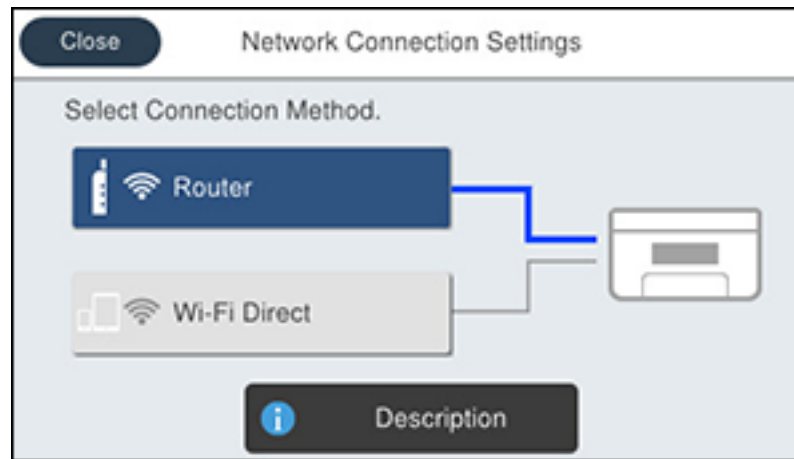

3. Select **Router > Change Settings > Others > Disable Wi-Fi > Start Setup**.
A message appears after Wi-Fi is disabled.

Parent topic: [Changing or Updating Network Connections](#)

Enabling PCL or PostScript Printing

Before enabling PCL or PostScript printing on your product, make sure you have installed the software as described on the *Start Here* sheet (WF-C5890).

To download the PCL or PostScript drivers, visit epson.com/support (U.S.), epson.ca/support (Canada), or latin.epson.com/support (Latin America) and select your product.

[Installing the PCL Driver - Windows](#)

[Installing the PostScript \(PS3\) Printer Software - Windows](#)

[Installing the PostScript \(PS3\) Printer Software - Mac](#)

[Selecting PDL \(Page Description Language\) Settings](#)

[Selecting Printer Language and Interface Settings](#)

[Printing a PCL or PS3 \(PostScript\) Status Sheet](#)

Installing the PCL Driver - Windows

The PCL driver can be installed on a Windows computer. Before enabling PCL printing on your product, make sure you have installed the software as described on the *Start Here* sheet.

Note: Make sure your product is turned on and connected to the same network as your computer before installing the printer software. Depending on your model, not all printer languages may be supported.

1. To download the PCL file, visit epson.com/support (U.S.), epson.ca/support (Canada), or latin.epson.com/support (Latin America) and select your product.
2. After downloading the installer file, double-click the downloaded file to install the software.

3. Follow the on-screen instructions until you see this screen:

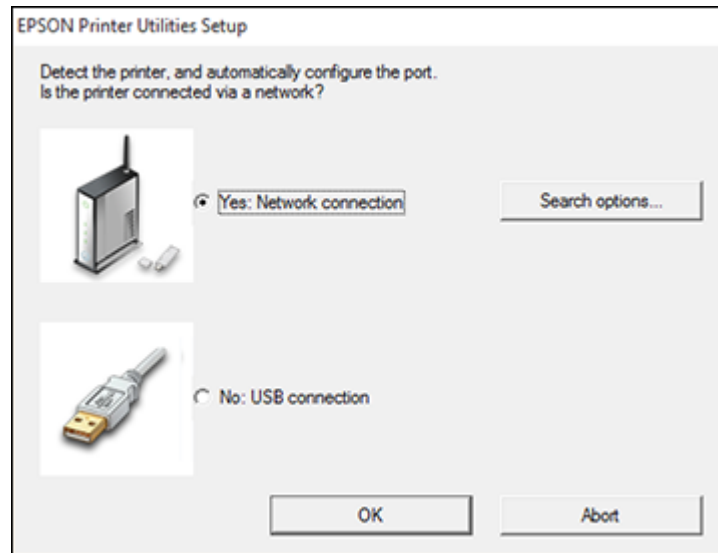

4. If your product is already connected to a network, select **Yes: Network connection** and click **OK**. You see a screen like this:

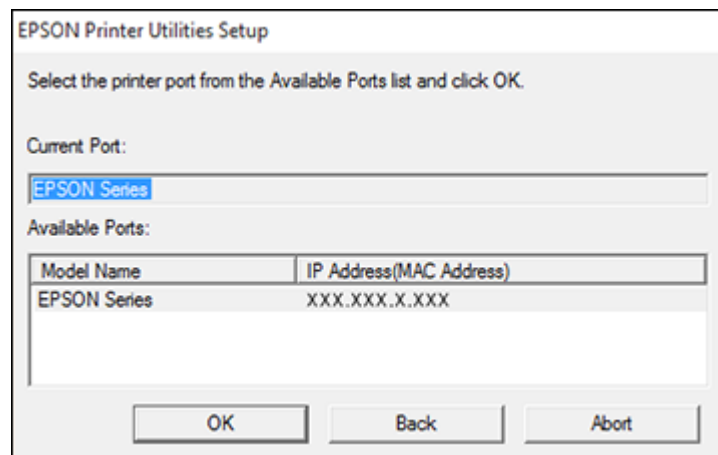

5. Make sure your product is selected, and click **OK**.
A message appears when the installation is complete.
6. If your product is not connected to a network, select **No: USB connection** and click **OK**. Connect a USB cable to your product's USB port, and connect the other end of the cable to your computer.
A message appears when the installation is complete.

Parent topic: [Enabling PCL or PostScript Printing](#)

Installing the PostScript (PS3) Printer Software - Windows

If you did not install the standard Epson printer software or Epson Universal Print Driver, you need to install the PostScript (PS3) printer software before you can adjust the print settings and print to your network printer.

Note: Make sure your product is turned on and connected to the same network as your computer before installing the printer software.

1. To download the **Drivers and Utilities Combo Package - PS3 PostScript** file, visit epson.com/support (U.S.), epson.ca/support (Canada), or latin.epson.com/support (Latin America) and select your product.
2. After downloading the installer file, double-click the downloaded file to install the software.
3. Click **OK**.
4. Click **Accept**.
5. Click **Install**.
6. Click **Next** and follow the on-screen instructions.

Parent topic: [Enabling PCL or PostScript Printing](#)

Installing the PostScript (PS3) Printer Software - Mac

If you did not install the standard Epson printer software, you need to install the PostScript (PS3) printer software before you can adjust the print settings and print to your network printer.

Note: Make sure your product is turned on and connected to the same network as your computer before installing the printer software.



1. To download the **Drivers and Utilities Combo Package - PS3 PostScript** file, visit epson.com/support (U.S), epson.ca/support (Canada), or latin.epson.com/support (Latin America) and select your product.
2. After downloading the installer file, double-click the downloaded file to install the software.
3. Double-click **EPSON**.
4. Click **Continue** on the next two screens.
5. Click **Agree**.
6. Click **Install**.
7. If necessary, enter the administrator password.
8. Click **Start** and follow the on-screen instructions.

Parent topic: [Enabling PCL or PostScript Printing](#)

Selecting PDL (Page Description Language) Settings

You can select settings for PCL and PostScript printing using the control panel on the product.

Note: These settings can be locked by an administrator. If you cannot access these settings, contact your administrator for assistance.

1. Press the  home button, if necessary.
2. Select **Settings > General Settings > Printer Settings > PDL Print Configuration**.
3. Select one of the available options, then select the PDL print configuration options you want to use.
4. When you are finished, press the  home button to exit.

[PDL Print Configuration Options](#)

Parent topic: [Enabling PCL or PostScript Printing](#)

PDL Print Configuration Options

Select the **PDL Print Configuration** options you want to use for PCL or PostScript printing.

Common Settings menu

Option	Available settings	Description
Paper Size	Various sizes	Sets the default paper size for PCL or PostScript printing
Paper Type	Various paper types	Sets the default paper type for PCL or PostScript printing
Orientation	Portrait	Sets the default orientation for PCL or PostScript printing
	Landscape	
Quality	Draft	Sets the quality for PCL or PostScript printing
	Standard	
	Best	
Ink Save Mode	On/Off	Saves ink by reducing print density
Print Order	Last Page on Top	Starts printing from the first page of a file
	First Page on Top	Starts printing from the last page of a file
Number of Copies	1 to 999	Selects the number of copies to print
Binding Margin	Left Edge	Specifies the binding edge for double-sided documents
	Top Edge	
Auto Paper Ejection	On/Off	Ejects paper automatically when printing is stopped during a print job
2-Sided Printing	On/Off	Selects duplex printing

PCL Menu

Option	Available settings	Description
Font Source	Resident	Uses a font preinstalled on the printer
	Download	Uses a font you have downloaded
Font Number	1 to 111	Selects the default font number for the default font source

Option	Available settings	Description
Pitch	0.44 to 99.99 cpi	Selects the default font pitch if the font is scalable and fixed-pitch (availability depends on font source and number settings)
Height	4.00 to 999.75 pt	Selects the default font height if the font is scalable and proportional (availability depends on font source and number settings)
Symbol Set	Various	Selects the default symbol set. If the selected font is not available for the selected symbol set, the font source and number are replaced with IBM-US (the default setting).
Form	5 to 128 lines	Sets the number of lines for the selected paper size and orientation. Changes the line spacing (VMI) stored in the printer. Later changes in page size or orientation cause changes in the Form value based on the stored VMI.
CR Function	CR	Selects the line feed command when printing with a driver from a specific operating system
	CR+LF	
LF Function	LF	
	CR+LF	
Paper Source Assign	4	Makes the paper source select command compatible with HP LaserJet 4
	4K	Makes the paper source select command compatible with HP LaserJet 4000, 5000, and 8000
	5S	Makes the paper source select command compatible with HP LaserJet 5S

PS Menu

Option	Available settings	Description
Error Sheet	On/Off	Prints a sheet showing the status when errors occur during PostScript or PDF printing



Option	Available settings	Description
Coloration	Color	Selects the color mode for PostScript printing
	Mono	
Binary	On/Off	Enable when printing files that contain binary images (available when the product is connected to the network). Allows you to print binary images even if the driver is set to ASCII.
PDF Page Size	Various sizes	Selects the paper size when printing a PDF file. If Auto is selected, the paper size is determined based on the size of the first page.

Parent topic: [Selecting PDL \(Page Description Language\) Settings](#)

Selecting Printer Language and Interface Settings

You can select printer language and interface settings using the control panel on the product.

Note: These settings can be locked by an administrator. If you cannot access these settings, contact your administrator for assistance.

1. Press the  home button, if necessary.
2. Select **Settings > General Settings > Printer Settings**.
3. Select the printing language and interface options for your connection type.
4. When you are finished, press the  home button to return to the Home screen.

[Printing Language and Interface Options](#)

Parent topic: [Enabling PCL or PostScript Printing](#)

Printing Language and Interface Options

Select the printing language and interface options you want to use.

Main **Printer Settings** menu

Option	Available settings	Description
PC Connection via USB	Enable	Select whether to allow USB communication with the product
	Disable	
USB I/F Timeout Setting	0 to 300 seconds	Specify the length of time before ending USB communication from a computer using the PCL or PostScript driver. This setting is necessary to avoid endless USB communication.

Printing Language menu

Option	Available settings	Description
USB	Auto PCL PS PDF	Select the language for the USB or network interface
Network		

Parent topic: [Selecting Printer Language and Interface Settings](#)

Printing a PCL or PS3 (PostScript) Status Sheet

You can print a PCL or PS3 (PostScript) status sheet to confirm the current font information.

1. Press the  home button, if necessary.
2. Select **Settings** > **Printer Status/Print** > **Print Status Sheet**.
3. Select **PS Font List** or **PCL Font List**.
4. Select **Print** to print the status sheet.

Parent topic: [Enabling PCL or PostScript Printing](#)

Loading Paper

Before you print, load paper for the type of printing you will do.

Note: Load only plain paper when printing with the PCL or PostScript (PS3) printer software (WF-C5890).

[Loading Paper in the Paper Cassettes and Rear Paper Tray](#)

[Paper Loading Capacity](#)

[Double-sided Printing Capacity](#)

[Compatible Epson Papers](#)

[Paper or Media Type Settings - Printing Software](#)

[Selecting the Paper Settings for Each Source - Control Panel](#)

[Selecting Default Paper Settings - Administrator](#)

Loading Paper in the Paper Cassettes and Rear Paper Tray

You can load paper up to Legal (8.5 × 14 inches [216 × 356 mm]) in the paper cassettes and the rear paper tray.

1. To view animated instructions on how to load paper in the rear paper tray or paper cassettes, press the ⓘ help button and select **How To > Load Paper**. Select a paper source and paper type.
2. If you are loading pre-punched paper, glossy paper, envelopes, or long paper in the rear paper tray, do one of the following:
 - Load one sheet of pre-punched paper, short edge first as shown.

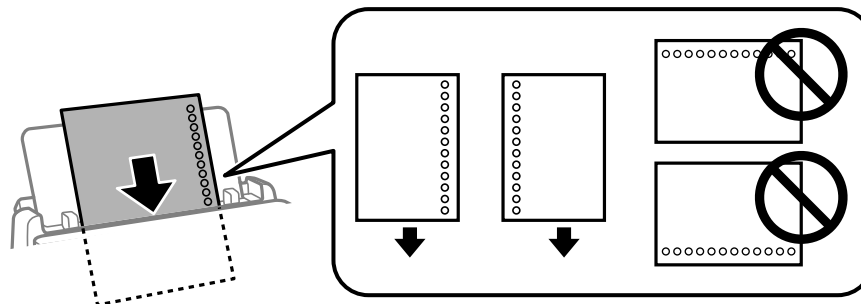

- Load sheets of paper with their glossy or printable side visible.
- Load up to 10 envelopes, short edge first with the flap facing down and to the left
- Load long paper by allowing the paper to roll over as shown. Select the user-defined setting as the paper size setting.

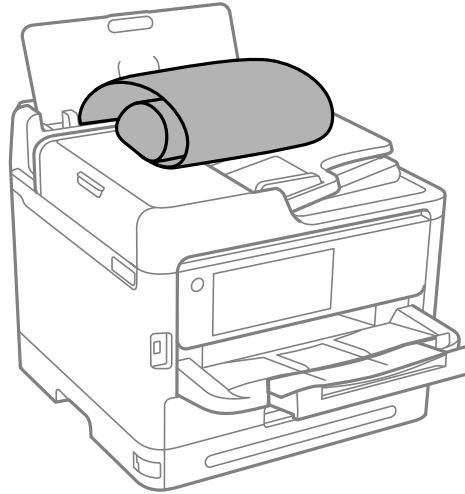

3. Set the paper size and type on the LCD.

Note: If you do not want to display the paper settings screen when you load paper, set the **Settings > General Settings > Printer Settings > Paper Source Settings > Paper Setup Auto Display** setting to **Off**.

Always follow these paper loading guidelines:

- Load only the recommended number of sheets.
- Load paper short edge first, no matter which way your document faces.
- Load letterhead or pre-printed paper top edge first.
- Do not load paper above the arrow mark inside the edge guides.
- Check the paper package for any additional loading instructions.

Caution: Do not load the following papers; they may cause paper jams, smears on the printout, or damage to the printer.

- Papers that are wavy or damp
- Papers that have not dried after printing on one side
- Papers that are wadded or curled
- Papers that are torn, cut, or folded
- Papers that are too thick or thin
- Pre-printed papers printed by other inkjet printers, thermal transfer printers, page printers, or copiers
- Papers that are perforated
- Papers that have stickers
- Papers held together with tape, staples, or paper clips
- Envelopes with adhesive surfaces or windows

Parent topic: [Loading Paper](#)

Related references

[Paper Source Settings Options](#)

[Paper Loading Capacity](#)

[Paper Specifications](#)

Paper Loading Capacity

Paper type	Paper cassette loading capacity	
Plain paper	250 sheets (cassette 1):	500 sheets (cassettes 2 to 4):
Pre-printed paper	A6 (4.1 × 5.8 inches [105 × 148 mm])	A6 (4.1 × 5.8 inches [105 × 148 mm])
Letterhead paper	A5 (5.8 × 8.2 inches [148 × 210 mm])	A5 (5.8 × 8.2 inches [148 × 210 mm])
Colored paper	A4 (8.3 × 11.7 inches [210 × 297 mm])	A4 (8.3 × 11.7 inches [210 × 297 mm])
Recycled paper	B5 (7.2 × 10.1 inches [182 × 257 mm])	B5 (7.2 × 10.1 inches [182 × 257 mm])
	Half Letter (5.5 × 8.5 inches [140 × 216 mm])	B4 (13.9 × 9.84 inches [353 × 250 mm])
	Executive (7.25 × 10.5 inches [184 × 267 mm])	Executive (7.25 × 10.5 inches [184 × 267 mm])
	Oficio 9 (8.46 × 12.4 inches [215 × 315 mm])	Oficio 9 (8.46 × 12.4 inches [215 × 315 mm])
	Letter (8.5 × 11 inches [216 × 279 mm])	Letter (8.5 × 11 inches [216 × 279 mm])
	8.5 × 13 inches (216 × 330 mm)	8.5 × 13 inches (216 × 330 mm)
	Mexico-Oficio (8.5 × 13.4 inches [216 × 340 mm])	Mexico-Oficio (8.5 × 13.4 inches [216 × 340 mm])
	Legal (8.5 × 14 inches [216 × 356 mm])	Legal (8.5 × 14 inches [216 × 356 mm])
	User-Defined (3.3 × 4.9 inches to 8.5 × 14 inches [85 × 125 mm to 216 × 356 mm])	User-Defined (3.9 × 5.8 inches to 8.5 × 14 inches [100 × 148 mm to 216 × 356 mm])
Epson Bright White Pro Paper	200 sheets (cassette 1) or 400 sheets (cassettes 2 to 4): Letter (8.5 × 11 inches [216 × 279 mm])	

Paper type	Paper cassette loading capacity	
Epson Bright White Premium Paper Epson Multipurpose Plus Paper	250 sheets (cassette 1) or 500 sheets (cassettes 2 to 4): Letter (8.5 × 11 inches [216 × 279 mm])	
Epson High Quality Ink Jet Paper Epson Presentation Paper Matte	80 sheets Letter (8.5 × 11 inches [216 × 279 mm]) A4 (8.3 × 11.7 inches [210 × 297 mm])	
Epson Ultra Premium Photo Paper Glossy Epson Premium Photo Paper Glossy Epson Premium Photo Paper Semi-gloss Epson Photo Paper Glossy Epson Premium Presentation Paper Matte	50 (cassette 1): 4 × 6 inches (102 × 152 mm) 5 × 7 inches (127 × 178 mm) 8 × 10 inches (203 × 254 mm) Letter (8.5 × 11 inches [216 × 279 mm])	50 (cassettes 2 to 4): Letter (8.5 × 11 inches [216 × 279 mm]) 8 × 10 inches (203 × 254 mm)

Paper type	Paper cassette loading capacity	
Card Stock 1 (25 to 42 lb [91 to 160 g/m ²])	90 sheets (cassette 1) A6 (4.1 × 5.8 inches [105 × 148 mm]) A5 (5.8 × 8.2 inches [148 × 210 mm]) A4 (8.3 × 11.7 inches [210 × 297 mm]) B6 (5 × 7.2 inches [128 × 182 mm]) B5 (7.2 × 10.1 inches [182 × 257 mm]) Half Letter (5.5 × 8.5 inches [140 × 216 mm]) Executive (7.25 × 10.5 inches [184 × 267 mm]) Oficio 9 (8.46 × 12.4 inches [215 × 315 mm]) Letter (8.5 × 11 inches [216 × 279 mm]) 8.5 × 13 inches (216 × 330 mm) Mexico-Oficio (8.5 × 13.4 inches [216 × 340 mm]) Legal (8.5 × 14 inches [216 × 356 mm]) User-Defined (3.3 × 4.9 inches to 8.5 × 14 inches [85 × 125 mm to 216 × 356 mm])	250 sheets (cassettes 2 to 4): A6 (4.1 × 5.8 inches [105 × 148 mm]) A5 (5.8 × 8.2 inches [148 × 210 mm]) A4 (8.3 × 11.7 inches [210 × 297 mm]) B6 (5 × 7.2 inches [128 × 182 mm]) B5 (7.2 × 10.1 inches [182 × 257 mm]) Half Letter (5.5 × 8.5 inches [140 × 216 mm]) Executive (7.25 × 10.5 inches [184 × 267 mm]) Oficio 9 (8.46 × 12.4 inches [215 × 315 mm]) Letter (8.5 × 11 inches [216 × 279 mm]) 8.5 × 13 inches (216 × 330 mm) Mexico-Oficio (8.5 × 13.4 inches [216 × 340 mm]) Legal (8.5 × 14 inches [216 × 356 mm]) User-Defined (3.9 × 5.8 inches to 8.5 × 14 inches [100 × 148 mm to 216 × 356 mm])
Card Stock 2 (43 to 68 lb [161 to 256 g/m ²])	— (cassette 1)	— (cassettes 2 to 4)
Envelopes	10 (cassette 1)	— (cassettes 2 to 4)

Paper type	Rear paper tray loading capacity
Plain paper Pre-printed paper Letterhead paper Colored paper Recycled paper	80 sheets: A6 (4.1 × 5.8 inches [105 × 148 mm]) A5 (5.8 × 8.2 inches [148 × 210 mm]) A4 (8.3 × 11.7 inches [210 × 297 mm]) B5 (7.2 × 10.1 inches [182 × 257 mm]) Half Letter (5.5 × 8.5 inches [140 × 216 mm]) Executive (7.25 × 10.5 inches [184 × 267 mm]) Oficio 9 (8.46 × 12.4 inches [215 × 315 mm]) Letter (8.5 × 11 inches [216 × 279 mm]) 8.5 × 13 inches (216 × 330 mm) Mexico-Oficio (8.5 × 13.4 inches [216 × 340 mm]) Legal (8.5 × 14 inches [216 × 356 mm]) User-Defined (2.5 × 4.9 inches to 8.5 × 236 inches [64 × 125 mm to 216 × 6000 mm])
Epson Bright White Pro Paper Epson Bright White Premium Paper Epson Multipurpose Plus Paper	50 sheets
Epson High Quality Ink Jet Paper Epson Presentation Paper Matte	70 sheets
Epson Ultra Premium Photo Paper Glossy Epson Premium Photo Paper Glossy Epson Premium Photo Paper Semi-gloss Epson Photo Paper Glossy Epson Premium Presentation Paper Matte	20 sheets

Paper type	Rear paper tray loading capacity
Card Stock 1 (25 to 42 lb [91 to 160 g/m ²]) Card Stock 2 (43 to 68 lb [161 to 256 g/m ²])	30 sheets: A6 (4.1 × 5.8 inches [105 × 148 mm]) A5 (5.8 × 8.2 inches [148 × 210 mm]) A4 (8.3 × 11.7 inches [210 × 297 mm]) B6 (5 × 7.2 inches [128 × 182 mm]) B5 (7.2 × 10.1 inches [182 × 257 mm]) Half Letter (5.5 × 8.5 inches [140 × 216 mm]) Executive (7.25 × 10.5 inches [184 × 267 mm]) Oficio 9 (8.46 × 12.4 inches [215 × 315 mm]) Letter (8.5 × 11 inches [216 × 279 mm]) 8.5 × 13 inches (216 × 330 mm) Mexico-Oficio (8.5 × 13.4 inches [216 × 340 mm]) Legal (8.5 × 14 inches [216 × 356 mm])
Envelopes	10

Parent topic: [Loading Paper](#)

Double-sided Printing Capacity

Paper type	Auto duplex (paper cassettes)	
Plain paper	250 sheets (cassette 1):	500 sheets (cassettes 2 to 4):
Pre-printed paper	A5 (5.8 × 8.2 inches [148 × 210 mm])	A5 (5.8 × 8.2 inches [148 × 210 mm])
Letterhead paper	A4 (8.3 × 11.7 inches [210 × 297 mm])	A4 (8.3 × 11.7 inches [210 × 297 mm])
Colored paper	B5 (7.2 × 10.1 inches [182 × 257 mm])	B5 (7.2 × 10.1 inches [182 × 257 mm])
Recycled paper	Executive (7.25 × 10.5 inches [184 × 267 mm])	Executive (7.25 × 10.5 inches [184 × 267 mm])
	Letter (8.5 × 11 inches [216 × 279 mm])	Letter (8.5 × 11 inches [216 × 279 mm])
	User-Defined (5.8 × 8.2 inches to 8.5 × 11.7 inches [148 × 210 mm to 216 × 297 mm])	User-Defined (5.8 × 8.2 inches to 8.5 × 11.7 inches [148 × 210 mm to 216 × 297 mm])
Epson Bright White Pro Paper	200 sheets (cassette 1)	400 sheets (cassettes 2 to 4)
Epson Bright White Premium Paper		
Epson Multipurpose Plus Paper		

Paper type	Auto duplex (paper cassettes)	
Card Stock 1 (25 to 42 lb [91 to 160 g/m ²])	90 sheets (cassette 1): A5 (5.8 × 8.2 inches [148 × 210 mm]) A4 (8.3 × 11.7 inches [210 × 297 mm]) B5 (7.2 × 10.1 inches [182 × 257 mm]) Executive (7.25 × 10.5 inches [184 × 267 mm]) Letter (8.5 × 11 inches [216 × 279 mm]) User-Defined (5.8 × 8.2 inches to 8.5 × 11.7 inches [148 × 210 mm to 216 × 297 mm])	250 sheets (cassettes 2 to 4): A5 (5.8 × 8.2 inches [148 × 210 mm]) A4 (8.3 × 11.7 inches [210 × 297 mm]) B5 (7.2 × 10.1 inches [182 × 257 mm]) Executive (7.25 × 10.5 inches [184 × 267 mm]) Letter (8.5 × 11 inches [216 × 279 mm]) User-Defined (5.8 × 8.2 inches to 8.5 × 11.7 inches [148 × 210 mm to 216 × 297 mm])

Paper type	Manual duplex (rear paper tray)
Plain paper Pre-printed paper Letterhead paper Colored paper Recycled paper	30 sheets: A5 (5.8 × 8.2 inches [148 × 210 mm]) A4 (8.3 × 11.7 inches [210 × 297 mm]) B5 (7.2 × 10.1 inches [182 × 257 mm]) Half Letter (5.5 × 8.5 inches [140 × 216 mm]) Executive (7.25 × 10.5 inches [184 × 267 mm]) Letter (8.5 × 11 inches [216 × 279 mm]) Oficio 9 (8.46 × 12.4 inches [215 × 315 mm]) 8.5 × 13 inches (216 × 330 mm) Mexico-Oficio (8.5 × 13.4 inches [216 × 340 mm]) Legal (8.5 × 14 inches [216 × 356 mm]) User-Defined (5.8 × 8.2 inches to 8.5 × 11.7 inches [148 × 210 mm to 216 × 297 mm])

Paper type	Manual duplex (rear paper tray)
Epson Bright White Pro Paper Epson Bright White Premium Paper Epson Multipurpose Plus Paper	30 sheets
Card Stock 1 (25 to 42 lb [91 to 160 g/m ²]) Card Stock 2 (43 to 68 lb [161 to 256 g/m ²])	5 sheets: A6 (4.1 × 5.8 inches [105 × 148 mm]) A5 (5.8 × 8.2 inches [148 × 210 mm]) A4 (8.3 × 11.7 inches [210 × 297 mm]) B6 (5 × 7.2 inches [128 × 182 mm]) B5 (7.2 × 10.1 inches [182 × 257 mm]) Half Letter (5.5 × 8.5 inches [140 × 216 mm]) Executive (7.25 × 10.5 inches [184 × 267 mm]) Oficio 9 (8.46 × 12.4 inches [215 × 315 mm]) Letter (8.5 × 11 inches [216 × 279 mm]) 8.5 × 13 inches (216 × 330 mm) Mexico-Oficio (8.5 × 13.4 inches [216 × 340 mm]) Legal (8.5 × 14 inches [216 × 356 mm]) User-Defined (5.8 × 8.2 inches to 8.5 × 11.7 inches [148 × 210 mm to 216 × 297 mm])

Parent topic: [Loading Paper](#)

Related tasks

[Selecting Double-sided Printing Settings - Windows](#)

[Selecting Double-sided Printing Settings - Mac](#)

Compatible Epson Papers

You can purchase genuine Epson ink, maintenance boxes, and paper at epson.com (U.S. sales), epson.ca (Canadian sales), or latin.epson.com (Latin American sales). You can also purchase supplies from an Epson authorized reseller. To find the nearest one, call 800-GO-EPSON (800-463-7766) in the U.S. or 800-807-7766 in Canada.

Note: Paper/media availability varies by country.

Paper Type	Size	Part number	Sheet count
Epson Bright White Pro Paper	Letter (8.5 × 11 inches [216 × 279 mm])	S041586	500
Epson Bright White Premium Paper	Letter (8.5 × 11 inches [216 × 279 mm])	S450218-4	500
Epson Multipurpose Plus Paper	Letter (8.5 × 11 inches [216 × 279 mm])	S450217-4	500
Epson High Quality Ink Jet Paper	Letter (8.5 × 11 inches [216 × 279 mm])	S041111	100
Epson Presentation Paper Matte	Letter (8.5 × 11 inches [216 × 279 mm])	S041062	100
Epson Premium Presentation Paper Matte	Letter (8.5 × 11 inches [216 × 279 mm])	S041257	50
		S042180	100
Epson Photo Paper Glossy	4 × 6 inches (102 × 152 mm)	S041809	50
		S042038	100
	Letter (8.5 × 11 inches [216 × 279 mm])	S041141	20
		S041649	50
S041271		100	
A4 (8.3 × 11.7 inches [210 × 297 mm])	S041140	20	
Epson Premium Photo Paper Glossy	4 × 6 inches (102 × 152 mm)	S041808	40
		S041727	100
	16:9 wide (4 × 7.1 inches [102 × 181 mm])	S042109	20
	5 × 7 inches (127 × 178 mm)	S041464	20
	8 × 10 inches (203 × 254 mm)	S041465	20
Letter (8.5 × 11 inches [216 × 279 mm])	S042183	25	
	S041667	50	

Paper Type	Size	Part number	Sheet count
Epson Ultra Premium Photo Paper Glossy	4 × 6 inches (102 × 152 mm)	S042181	60
		S042174	100
	5 × 7 inches (127 × 178 mm)	S041945	20
	8 × 10 inches (203 × 254 mm)	S041946	20
Epson Premium Photo Paper Semi-gloss	Letter (8.5 × 11 inches [216 × 279 mm])	S042182	25
		S042175	50
Epson Premium Photo Paper Semi-gloss	4 × 6 inches (102 × 152 mm)	S041982	40
	Letter (8.5 × 11 inches [216 × 279 mm])	S041331	20

Parent topic: [Loading Paper](#)

Paper or Media Type Settings - Printing Software

For this paper	Select this paper Type or Media Type setting
Plain paper Epson Bright White Pro Paper Epson Bright White Premium Paper Epson Multipurpose Plus Paper	Plain Paper / Bright White Paper
Letterhead paper	Letterhead
Recycled paper	Recycled
Colored paper	Color
Pre-printed paper	Preprinted
Epson High Quality Ink Jet Paper	High Quality Plain Paper
Thick paper up to 25 to 42 lb (91 to 160 g/m ²)	Card Stock 1
Thick paper up to 43 to 68 lb (161 to 256 g/m ²)	Card Stock 2
Envelopes	Envelope
Epson Ultra Premium Photo Paper Glossy	Ultra Premium Photo Paper Glossy



For this paper	Select this paper Type or Media Type setting
Epson Premium Photo Paper Glossy	Premium Photo Paper Glossy
Epson Photo Paper Glossy	Photo Paper Glossy
Epson Premium Photo Paper Semi-gloss	Premium Photo Paper Semi-Gloss
Epson Premium Presentation Paper Matte	Premium Presentation Paper Matte
Epson Presentation Paper Matte	Presentation Paper Matte

Note: The settings listed here are available only when printing from your computer; they do not apply to your product's control panel settings.

Parent topic: [Loading Paper](#)

Selecting the Paper Settings for Each Source - Control Panel

You can change the default paper size and paper type for each source using the control panel on the product.

1. Press the  **Paper Setting** button.
2. Select the paper source you want to select settings for.
3. Select **Paper Size**.
4. Select the paper size you loaded.
5. Select **Paper Type**.
6. Select the paper type for the paper you loaded.
7. Select another paper source to change or press the  home button to exit.

[Paper Type Settings - Control Panel](#)

Parent topic: [Loading Paper](#)

Paper Type Settings - Control Panel

Select a **Paper Type** setting that matches the paper you loaded.

Paper type loaded	Paper Type setting
Plain paper Epson Bright White Pro Paper Epson Bright White Premium Paper Epson Multipurpose Plus Paper	Plain Paper
Letterhead paper	Letterhead
Recycled paper	Recycled
Colored paper	Color
Pre-printed paper	Preprinted
Epson High Quality Ink Jet Paper	High Quality Plain Paper
Thick paper up to 25 to 42 lb (91 to 160 g/m ²)	Card Stock 1
Thick paper up to 43 to 68 lb (161 to 256 g/m ²)	Card Stock 2
Envelopes	Envelope
Epson Ultra Premium Photo Paper Glossy	Ultra Glossy
Epson Premium Photo Paper Glossy	Prem. Glossy
Epson Photo Paper Glossy	Glossy
Epson Premium Photo Paper Semi-gloss	Prem. Semi-Gloss
Epson Premium Presentation Paper Matte	Prem. Matte
Epson Presentation Paper Matte	Presentation Matte

Parent topic: [Selecting the Paper Settings for Each Source - Control Panel](#)

Selecting Default Paper Settings - Administrator

As an administrator, you can adjust default paper settings that apply to all print jobs sent to the product.

Note: These settings can be locked by an administrator. If you cannot access these settings, contact your administrator for assistance.

[Selecting the Default Printer Settings](#)



[Selecting the Universal Print Settings](#)

Parent topic: [Loading Paper](#)

Selecting the Default Printer Settings

You can change default printer settings using the control panel on the product.

Note: These settings can be locked by an administrator. If you cannot access these settings, contact your administrator for assistance.

1. Press the  home button, if necessary.
2. Select **Settings > General Settings > Printer Settings**.
3. Select an **Auto Error Solver** setting:
 - Select **On** to display a warning and print single-sided when a 2-sided printing error occurs, or to print only what the printer could process when a full memory error occurs.
 - Select **Off** to display an error message and stop printing if an error occurs.
4. Select **Paper Source Settings**.
5. Select the options you want to use.
6. When you are finished, press the  home button to exit.

[Paper Source Settings Options](#)

Parent topic: [Selecting Default Paper Settings - Administrator](#)

Paper Source Settings Options

Select the paper source options you want to use for your print jobs.

Paper Source Settings option	Available settings	Description
Paper Setting	Various	Select the paper size and type for each paper source
Paper Tray Priority	On	Select On to give printing priority to paper loaded in the rear paper tray
	Off	
A4/Letter Auto Switching	On	Select On to switch the selected paper size to match the loaded paper (Letter or A4) if the wrong size is selected
	Off	



Paper Source Settings option	Available settings	Description
Auto Select Settings	Copy Fax Other	Select On for a paper source to allow the printer to automatically print on paper from that source if it matches your paper settings. You can set automatic selection for each function separately. If a paper source is specified during a print job, this setting will be ignored.
Automatic Selection at Paper Out : For Copy	On Off	Select On to enable switching to another paper source if paper runs out during copying. Both the chosen paper source and the alternate paper source must be enabled in the Auto Select Settings setting.
Error Notice	Paper Size Notice	Select On for either of these settings to display an error message when the selected paper type or size does not match the loaded paper
	Paper Type Notice	
Paper Setup Auto Display	On	Select On to automatically display a menu that lets you select the paper size and type when you load paper in the product Note: If you turn this setting off, you cannot use AirPrint.
	Off	

Parent topic: [Selecting the Default Printer Settings](#)

Selecting the Universal Print Settings

You can change the default universal print settings using the control panel on the product.

Note: These settings can be locked by an administrator. If you cannot access these settings, contact your administrator for assistance.

1. Press the  home button, if necessary.
2. Select **Settings** > **General Settings** > **Printer Settings** > **Universal Print Settings**.
3. Adjust the settings as necessary.
4. When you are finished, press the  home button to exit.

[Universal Print Settings Options](#)

Parent topic: [Selecting Default Paper Settings - Administrator](#)

Universal Print Settings Options

Select the universal print setting options you want to use for your print jobs.

Universal Print Settings option	Available settings	Description
Top Offset	—	Adjust the top or left margin
Left Offset		
Top Offset in Back	—	Adjust the top or left margin of the back page when printing double-sided.
Left Offset in Back		
Check Paper Width	On	Select On to check the paper width before printing. This prevents printing beyond the edges of the paper when the paper size settings are incorrect, but may reduce the printing speed.
	Off	
Skip Blank Page	On	Select On to skip printing of blank pages automatically
	Off	

Parent topic: [Selecting the Universal Print Settings](#)

Placing Originals on the Product

Follow the instructions here to place your original documents or photos on the product.

Caution: Do not place anything on top of your product or use its cover as a writing surface to avoid damaging it.

[Placing Originals in the Automatic Document Feeder](#)

[Placing Originals on the Scanner Glass](#)

Placing Originals in the Automatic Document Feeder

You can place single- or multi-page original documents in the Automatic Document Feeder (ADF). You can also use the ADF to scan both sides of a 2-sided document. Make sure the originals meet the Automatic Document Feeder specifications before loading them.

Caution: Do not load the following types of originals in the ADF, or they may be damaged or may damage the scanner. Use the scanner glass for these types:

- Ripped, curled, folded, deteriorated, or wrinkled originals
- Originals with holes
- Originals containing staples or paper clips
- Originals with carbon paper backing
- Originals with labels, stickers, or sticky notes
- Originals that are bound
- Originals that are cut irregularly or not cut at a right angle
- Photos or valuable artwork
- Thermal paper
- Transparencies
- Fabric or other non-paper originals
- Originals with uneven surfaces, such as embossed documents
- Originals with wet ink

Note: When originals are placed in the ADF and on the scanner glass, priority is given to the originals in the ADF.

Note: Do not load originals above the line under the triangle symbol on the ADF edge guide. Do not load originals while scanning.

1. Select the  icon and select **How To > Place Originals > ADF**.
2. Follow the on-screen instructions.

Parent topic: [Placing Originals on the Product](#)

Related references

[Automatic Document Feeder \(ADF\) Specifications](#)

Related topics

[Copying](#)

[Scanning](#)

[Faxing](#)

Placing Originals on the Scanner Glass

You can place originals up to this size on the scanner glass: Letter (8.5 × 11 inches [216 × 279 mm]) or A4 (8.3 × 11.7 inches [210 × 297 mm]).

Note: When originals are placed in the ADF and on the scanner glass, priority is given to the originals in the ADF.

1. Press the  help button and select **How To > Place Originals > Scanner Glass**.
2. Follow the onscreen instructions.

Caution: Be careful not to trap your hands or fingers when opening or closing the document cover. Do not push down on the document cover or scanner glass or you may damage the product.

Note: If there is any dust or dirt on the scanner glass, the scanning range may expand to include it, so the image of the original may be displaced or reduced. Use a soft, dry, clean cloth to remove any dust and dirt on the scanner glass before scanning. When placing bulky originals such as books, prevent exterior light from shining directly onto the scanner glass.

Note: The edges of your original may be cropped by 0.06 inch (1.5 mm) from the edge of the scanner glass. Manually position your original away from the edges to prevent cropping.

Remove your originals after scanning. If you leave the originals on the scanner glass for a long time, they may stick to the glass surface.

Parent topic: [Placing Originals on the Product](#)

Related topics

[Copying](#)

[Scanning](#)

[Faxing](#)

Copying

See the information here to copy documents or photos using your product.

Note: Copies may not be exactly the same size as your originals.

[Copying Documents or Photos](#)

[Copying Options](#)

Copying Documents or Photos

You can copy documents or photos onto various sizes and types of paper, including Epson special papers.

1. Place your original document or photo on the scanner glass, or place multi-page documents in the ADF.
2. Load the paper you want to print on.
3. Press the  home button, if necessary.
4. Select **Copy**.
5. To print more than one copy, press a number key on the product's control panel, or select **Copies** and use the displayed keypad to enter the number of copies.
6. Change any of the displayed settings as necessary.
7. Select **Advanced** to view and change additional copy settings, if necessary.
8. Select **Preview** to preview your copy on the LCD screen.
9. Select **Presets** to save your copy settings.

Note: Presets can be locked by an administrator. If you can't access or change this setting, contact your administrator for assistance.

10. When you are ready to copy, press the **Copy** icon.

Note: To cancel printing, press the  cancel button or select **Cancel**.

Parent topic: [Copying](#)

Related references

[Copying Options](#)

[Copying Options](#)

Related tasks

[Placing Originals in the Automatic Document Feeder](#)

[Placing Originals on the Scanner Glass](#)

[Loading Paper in the Paper Cassettes and Rear Paper Tray](#)

[Using Presets](#)

Copying Options

Select the copying options you want to use for your copies.

Note: Not all options or settings may be available, depending on other copying settings.

Basic Settings

Copying option	Available settings	Description
Color	—	Copies the document in color
B&W	—	Copies the document in black and white
Density	Varying levels	Adjusts the lightness or darkness of copies
Paper Setting	Various sources	Select the paper source that you want to use. If you select Auto , paper is fed automatically depending on the paper settings you selected for the paper sources.
Reduce/Enlarge	Auto	Automatically sizes the image to fit the paper size you selected
	100%	Copies the original at its full size
	Various percentages and other conversions	Automatically converts from one size to another
	Reduce to Fit Paper	Automatically decreases the size of the image by the percentage you select

Copying option	Available settings	Description
Original Type	Text	Specifies the document type of your originals and adjusts the quality of your copies
	Text & Image	
	Photo	
	Text & Image(Best)	
	Barcode	
2-Sided	1>1-Sided	Select to make 2-sided copies. When you select 2>2 Sided , 1>2-Sided , or 2>1-Sided , you can scroll down to select the orientation and binding edge for your originals or copies.
	2>2-Sided	
	1>2-Sided	
	2>1-Sided	

Advanced settings

Copying option	Available settings	Description
Multi-Page	Single Page	Copies each page of the original onto an individual sheet
	2-up	Copies multiple page documents onto one sheet. Scroll down and select the document orientation and layout order settings as necessary.
	4-up	
Original Size	Various sizes	Select the document size of your original. When copying non-standard sized originals, select the closest size.

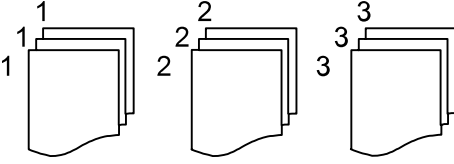
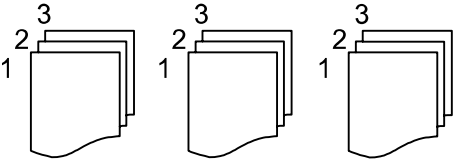
Copying option	Available settings	Description
Finishing	Group (Same Pages)	Select to print multiple copies of a multi-page document in unordered groups 
	Collate (Page Order)	Select to print multiple copies of a multi-page document in ordered sets 
Orientation (Original)	Readable Direction	Specifies the orientation of your originals
	Left Direction	
Image Quality	Various settings	Select advanced quality settings such as Saturation and Sharpness
Binding Margin	Off	Select On to adjust the margin, binding position, and orientation of the pages when copying a book
	On	
Reduce to Fit Paper	Off	Select On to automatically decrease the image by the percentage you select
	On	
Remove Shadow	Off	Select On to erase the shadows that appear in the center of a document when copying a book or that appear around a document when copying thick paper
	On	
Remove Punch Holes	Off	Select On to erase the binding holes on a document
	On	
ID Card Copy	Off	Select On to copy both sides of an ID card onto one side of a sheet of paper
	On	

Parent topic: [Copying](#)

Printing from a Computer

Before printing from your computer, make sure you have set up your product and installed its software as described on the *Start Here* sheet.

Note: If you have an Internet connection, it is a good idea to check for updates to your product software on Epson's support website. If you see a Software Update screen, select **Enable automatic checking** and click **OK**. The update scans your system to see if you have the latest product software. Follow the on-screen instructions.

[Printing with the Standard Epson Printer Software - Windows](#)

[Printing with the Built-in Epson Driver - Windows 10 S](#)

[Printing with the Epson Standard Printer Software - Mac](#)

[Setting Up Printing on a Chromebook](#)

[Printing from a Smartphone or Tablet](#)

[Printing with the PCL Printer Software - Windows](#)

[Printing with the PostScript \(PS3\) Printer Software - Windows](#)

[Printing with the PostScript \(PS3\) Printer Software - Mac](#)

[Cancelling Printing Using a Product Button](#)

Printing with the Standard Epson Printer Software - Windows

You can print with the standard Epson printer software using any Windows printing program, as described in these sections.

Note: If you are using your Epson product with the Windows 10 S operating system, you cannot use the software described in this section. You also cannot download and install any Epson product software from the Epson website for use with Windows 10 S; you must obtain software only from the Windows Store.

[Selecting Basic Print Settings - Windows](#)

[Selecting Double-sided Printing Settings - Windows](#)

[Selecting Additional Layout and Print Options - Windows](#)

[Selecting a Printing Preset - Windows](#)

[Selecting Extended Settings - Windows](#)

[Printing Your Document or Photo - Windows](#)

[Locking Printer Settings - Windows](#)
[Entering a User ID and Password for Printing](#)
[Selecting Default Print Settings - Windows](#)
[Changing Automatic Update Options](#)

Parent topic: [Printing from a Computer](#)

Selecting Basic Print Settings - Windows

Select the basic settings for the document or photo you want to print.

1. Open a photo or document for printing.
2. Select the print command in your application.

Note: You may need to select a print icon on your screen, the **Print** option in the File menu, or another command. See your application's help utility for details.

3. If necessary, select your product name as the printer you want to use.

Note: You may also need to select **Properties** or **Preferences** to view your print settings.

You see the Main tab of your printer settings window:

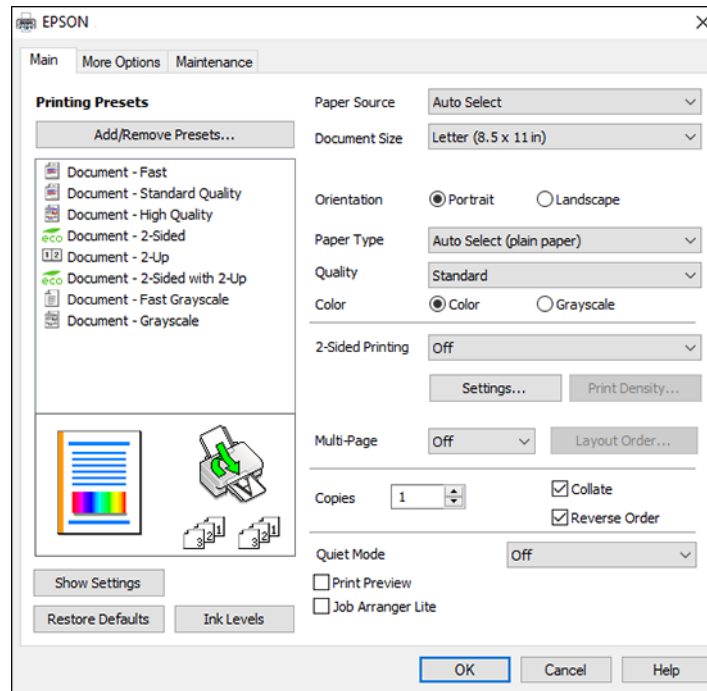

4. For the **Paper Source** setting, select where you loaded the paper you want to print on.
5. Select the size of the paper you loaded as the Document Size setting.

Note: You can also select the **User-Defined** setting to create a custom paper size.

6. Select the orientation of your document.

Note: If you are printing an envelope, select **Landscape**.

7. Select the type of paper you loaded as the Paper Type setting.

Note: The setting may not exactly match the name of your paper. Check the paper type settings list for details.

8. Select the **Quality** setting that matches the print quality you want to use.
9. Select a Color option:
 - To print a color document or photo, select the **Color** setting.
 - To print text and graphics in black or shades of gray, select the **Grayscale** setting.
10. To print on both sides of the paper, select the **2-Sided Printing** setting and select the options you want.
11. To print multiple pages on one sheet of paper, or print one image on multiple sheets of paper, select one of the settings in the Multi-Page menu and select the printing options you want.
12. To print multiple copies and arrange their print order, select the **Copies** options.
13. To preview your job before printing, select **Print Preview**.
14. To save your print job as a project that can be modified and combined with other print jobs, select **Job Arranger Lite**.
15. To reduce noise during printing when you select **Plain Paper/Bright White Paper**, select **On** in the Quiet Mode menu.

Note: Enabling **Quiet Mode** may reduce printing speed.

[Paper Source Options - Windows](#)

[Print Quality Options - Windows](#)

[Multi-Page Printing Options - Windows](#)

Parent topic: [Printing with the Standard Epson Printer Software - Windows](#)

Related references

[Paper or Media Type Settings - Printing Software](#)

Related tasks

[Printing Your Document or Photo - Windows](#)

[Entering a User ID and Password for Printing](#)

[Selecting Double-sided Printing Settings - Windows](#)

Paper Source Options - Windows

You can select any of the available options in the Paper Source menu to print on the paper loaded in that source.

Auto Select

Automatically selects the paper source based on the selected paper size.

Paper Cassette 1

Selects the paper in cassette 1 as the paper source.

Paper Cassette 2

Selects the paper in cassette 2 as the paper source.

Paper Cassette 3

Selects the paper in cassette 3 as the paper source.

Paper Cassette 4

Selects the paper in cassette 4 as the paper source.

Paper Tray

Selects the paper in the rear feed as the paper source.

Parent topic: [Selecting Basic Print Settings - Windows](#)

Print Quality Options - Windows

You can select any of the available Quality options to fine-tune the quality of your print. Some settings may be unavailable, depending on the paper type and border setting you have chosen.

Draft

For draft printing on plain paper.

Standard

For everyday text and image printing.

High

For photos and graphics with high print quality.

Parent topic: [Selecting Basic Print Settings - Windows](#)

Multi-Page Printing Options - Windows

You can select any of the available options in the Multi-Page menu to set up your multi-page print job.

2-Up, 4-Up, 6-Up, 8-Up, 9-Up, and 16-Up

Prints several pages on one sheet of paper. Click the **Layout Order** button to select page layout and border options.

2×1 Poster, 2×2 Poster, 3×3 Poster, 4×4 Poster

Prints one image on multiple sheets of paper to create a larger poster. Click the **Settings** button to select image layout and guideline options.

Parent topic: [Selecting Basic Print Settings - Windows](#)

Selecting Double-sided Printing Settings - Windows

You can print on both sides of the paper by selecting one of the 2-Sided Printing options on the Main tab.

Note: Some options may be pre-selected or unavailable, depending on other settings you have chosen or if you are accessing the product over a network.

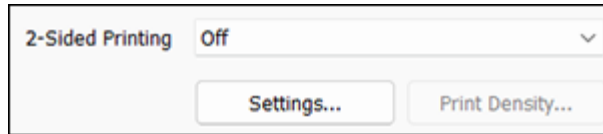

1. Select one of the following options for **2-Sided Printing**:
 - **Auto (Long-edge binding)** to print your double-sided print job by automatically flipping the paper on the long edge.
 - **Auto (Short-edge binding)** to print your double-sided print job by automatically flipping the paper on the short edge.
2. Click the **Settings** button.

You see this window:

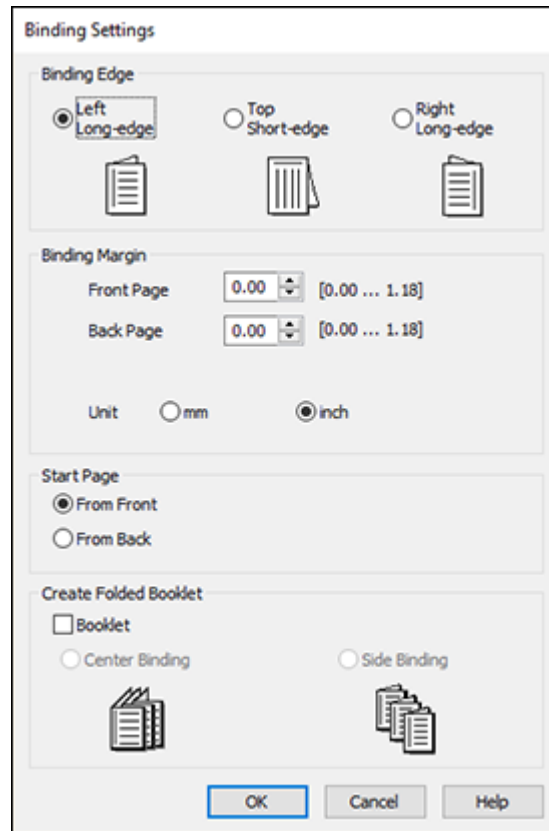

3. Select the double-sided printing options you want to use.
4. Click **OK** to return to the Main tab.
5. Click the **Print Density** button.

You see this window:

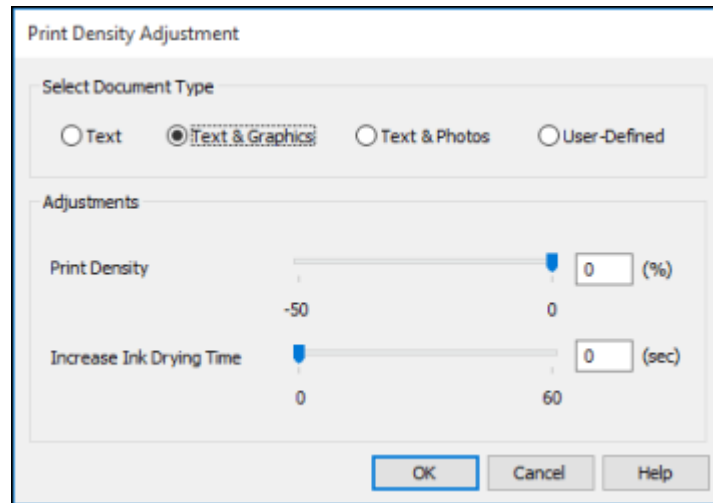

6. Select the type of document you are printing as the Document Type setting. The software automatically sets the Adjustments options for that document type.
7. If necessary, select the Adjustments options you want to use.
8. Click **OK** to return to the Main tab.
9. Print a test copy of your double-sided document to test the selected settings.
10. Follow any instructions displayed on the screen during printing.

[Double-sided Printing Options - Windows](#)

[Print Density Adjustments - Windows](#)

Parent topic: [Printing with the Standard Epson Printer Software - Windows](#)

Related references

[Double-sided Printing Capacity](#)

Related tasks

[Selecting Basic Print Settings - Windows](#)

[Printing Your Document or Photo - Windows](#)

Double-sided Printing Options - Windows

You can select any of the available options on the 2-Sided Printing Settings window to set up your double-sided print job.

Binding Edge Options

Select a setting that orients double-sided print binding in the desired direction.

Binding Margin Options

Select options that define a wider margin to allow for binding.

Start Page

Selects whether printing starts on the front or back page.

Create Folded Booklet Options

Select the **Booklet** checkbox and a binding option to print double-sided pages as a booklet.

Parent topic: [Selecting Double-sided Printing Settings - Windows](#)

Print Density Adjustments - Windows

You can select any of the available options on the Print Density Adjustment window to adjust the print quality of your double-sided print job.

Print Density

Sets the level of ink coverage for double-sided printing.

Increase Ink Drying Time

Sets the amount of time required for drying ink after printing on one side of the paper before printing the other side in double-sided printing to prevent ink smearing.

Parent topic: [Selecting Double-sided Printing Settings - Windows](#)

Selecting Additional Layout and Print Options - Windows

You can select a variety of additional layout and printing options for your document or photo on the **More Options** tab.

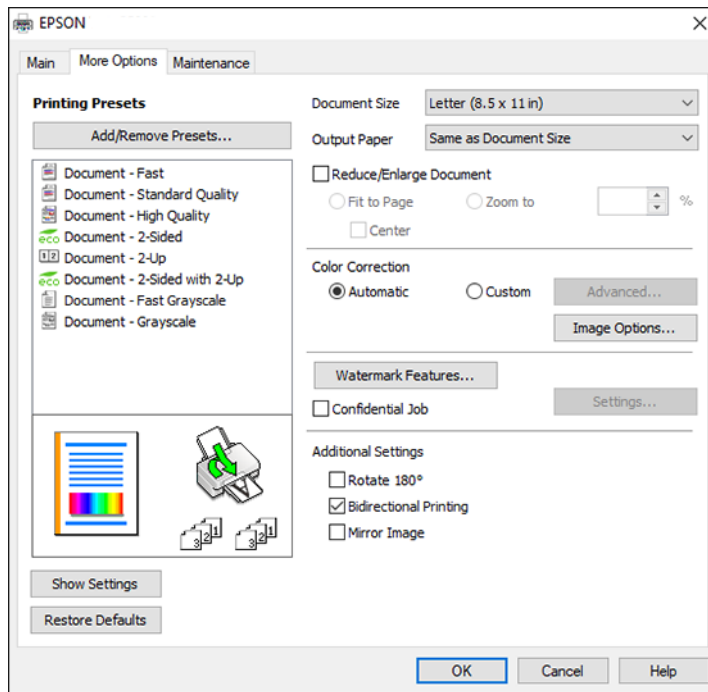

1. To change the size of your printed document or photo, select the **Reduce/Enlarge Document** checkbox and select one of these sizing options:
 - Select the **Fit to Page** option to size your image to fit the paper you loaded. Select the size of your document or photo as the Document Size setting, and the size of your paper as the Output Paper setting. If you want to center your image on the paper, select the **Center** option.
 - Select the **Zoom to** option to reduce or enlarge your document or photo by a specific percentage. Select the percentage in the % menu.
2. Select one of the following Color Correction options:
 - Select **Automatic** to automatically adjust the sharpness, brightness, contrast, and color saturation for your image.
 - Select **Custom** and click the **Advanced** button to manually adjust the color correction settings or turn off color management in your printer software.
 - Select **Image Options** to access additional settings for improving printed images.

Note: You can also select **Color Universal Print** settings.

3. To add the following features, click the **Watermark Features** button:

- **Anti-Copy Pattern:** adds a watermark that only appears when your printout is copied

Note: This setting is not available for all types of printing. Click the **Add/Delete** button to create your own pattern, and click the **Settings** button to customize the pattern.

- **Watermark:** adds a visible watermark to your printout

Note: Click the **Add/Delete** button to create your own watermark, and click the **Settings** button to customize the watermark.

- **Header/Footer:** adds information such as the date and time to the top or bottom of your printout

Note: Click the **Settings** button to customize the text and location of the header or footer.

4. To add a password to your print job, select the **Confidential Job** checkbox, then enter a password. Confidential jobs are stored in the product's memory without being printed. To print the job, enter the password for the confidential job on the product's control panel.

Note: Confidential print jobs are cleared from the product's memory after printing.

5. Select any of the Additional Settings options to customize your print.

[Custom Color Correction Options - Windows](#)

[Image Options and Additional Settings - Windows](#)

[Header/Footer Settings - Windows](#)

Parent topic: [Printing with the Standard Epson Printer Software - Windows](#)

Related tasks

[Printing Your Document or Photo - Windows](#)

Custom Color Correction Options - Windows

You can select any of the available options in the Color Correction window to customize the image colors for your print job.

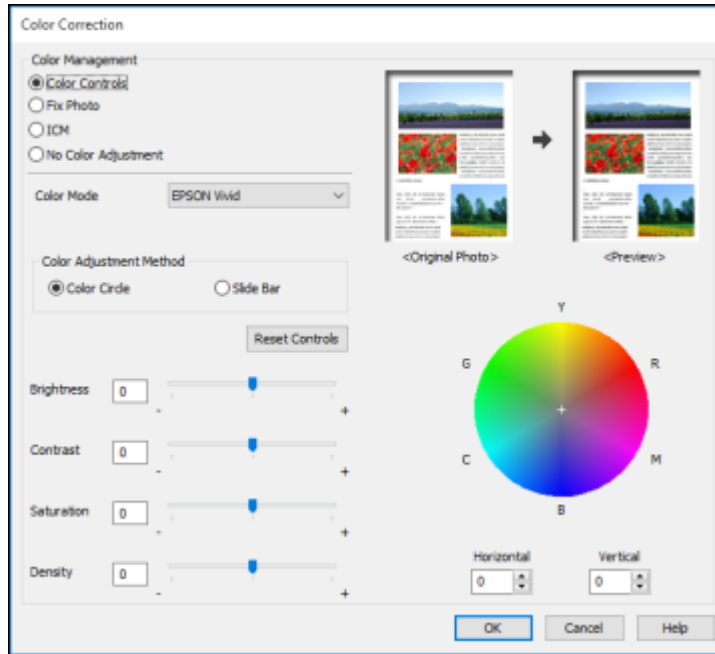

Color Controls

Lets you select a **Color Mode** setting, individual settings for **Brightness**, **Contrast**, **Saturation**, and **Density**, and individual color tones. Depending on the selected color mode, you can also adjust the midtone density using the **Gamma** setting.

Fix Photo

Improves the color, contrast, and sharpness of flawed photos.

Note: Fix Photo uses a sophisticated face recognition technology to optimize photos that include faces. For this to work, both eyes and the nose must be visible in the subject's face. If your photo includes a face with an intentional color cast, such as a statue, you may want to turn off **Fix Photo** to retain the special color effects.

ICM

Lets you manage color using installed color printing profiles.

No Color Adjustment

Turns off color management in your printer software so you can manage color using only your application software.

Parent topic: [Selecting Additional Layout and Print Options - Windows](#)

Image Options and Additional Settings - Windows

You can select any of the Image Options and Additional Settings to customize your print. Some options may be pre-selected or unavailable, depending on other settings you have chosen.

Image Options**Emphasize Text**

Adjusts the weight of printed text to increase readability.

Emphasize Thin Lines

Adjusts the weight of printed lines to increase visibility.

Edge Smoothing

Smooths jagged edges in low-resolution images such as screen captures or images from the Web.

Fix Red-Eye

Reduces or removes red-eye in photos.

Print Text in Black

Prints colored text in black.

For Color Text

Prints colored text on a background pattern or underlined.

For Color Graphs and Images

Prints colored graphics and images with overlay patterns.

For Color Text, Graphs, and Images

Prints colored text, graphics, and images with overlay patterns.

Enhancement Options

Specifies Color Universal Print enhancement settings for text, graphics, and images.

Additional Settings Options**Rotate 180°**

Prints the image rotated 180° from its original orientation.

Bidirectional Printing

Prints in both directions (right-to-left and left-to-right), speeding up printing, but may reduce print quality.

Mirror Image

Flips the printed image left to right.

Parent topic: [Selecting Additional Layout and Print Options - Windows](#)

Header/Footer Settings - Windows

You can select any of the Header/Footer Settings options to add headers or footers when you print. The items are available to print at the top or bottom of your pages, in either the left, right, or center of the page.

Note: These settings are not saved with your document.

The screenshot shows a dialog box titled "Header/Footer Settings". It is organized into several sections:

- Top Left:** A dropdown menu set to "User Name".
- Top Center:** A dropdown menu set to "None".
- Top Right:** A dropdown menu set to "Date/Time".
- Bottom Left:** A dropdown menu set to "None".
- Bottom Center:** A dropdown menu set to "None".
- Bottom Right:** A dropdown menu set to "None".
- Starting number:** A spinner box set to "1".
- Start printing on page:** A spinner box set to "1".
- Text:** An empty text input field.
- Color:** A dropdown menu set to "Black".
- Font:** A dropdown menu set to "Arial".
- Size:** A spinner box set to "11 pt [6 ... 72]".
- Style:** A text box containing "Bold" and "Italic" options.

At the bottom of the dialog are four buttons: "Reset Defaults", "OK", "Cancel", and "Help".

You can select to print the following information:

- User Name
- Computer Name
- Date
- Date/Time
- Document Name
- Collate Number (copy number)

- Page Number
- Text

You can also adjust the text settings for the printed information.

Note: The user name, computer name, date, and time come from the Windows Control Panel on your computer.

Parent topic: [Selecting Additional Layout and Print Options - Windows](#)

Selecting a Printing Preset - Windows

For quick access to common groups of print settings, you can select a printing preset on the **Main** or **More Options** tab.

Note: You can create your own preset by clicking the **Add/Remove Presets** button.

1. Click the **Main** or **More Options** tab.

You see the available **Printing Presets** on the left:

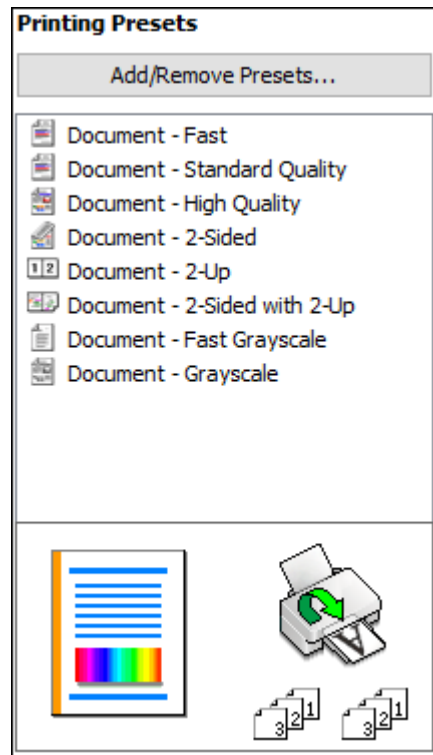



2. Place your cursor over one of the **Printing Presets** to view its list of settings.
3. Click on a preset to change its settings or delete it, or use any of the available options on the screen to control your printing presets.
4. To choose a preset for printing, select it.
5. Click **OK**.

Parent topic: [Printing with the Standard Epson Printer Software - Windows](#)

Selecting Extended Settings - Windows

You can select additional settings that apply to all the print jobs you send to your product.

1. Access the Windows Desktop and right-click the  icon for your product in the right side of the Windows taskbar, or click the up arrow and right-click .
2. Select **Printer Settings**.
3. Click the **Maintenance** tab.

You see the maintenance options:

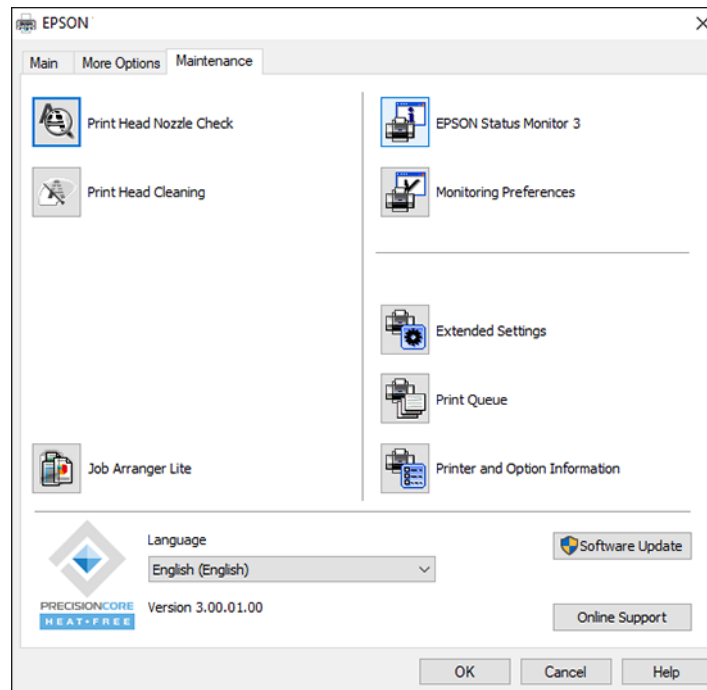

4. Click the **Extended Settings** button.

You see this window:

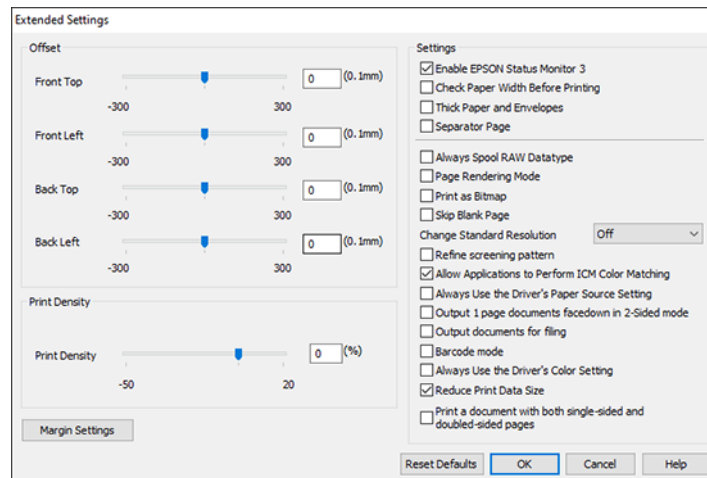

5. Select any of the extended settings to customize your print.
6. Click **OK** to close the Extended Settings window.
7. Click **OK** to close the printer software window.

[Extended Settings - Windows](#)

Parent topic: [Printing with the Standard Epson Printer Software - Windows](#)

Extended Settings - Windows

You can select these settings on the Extended Settings window.

Enable EPSON Status Monitor 3

Enables product monitoring for ink and paper supplies and other issues.

Check Paper Width Before Printing

Prevents printing beyond the edges of the paper if the paper size setting is incorrect; may reduce print speed.

Thick Paper and Envelopes

Prevents ink from smearing when you print on envelopes or other thick paper.

Separator Page

Before each document, prints a separator page containing the title, user, date, and time.

Always Spool RAW Datatype

Increases print speed and may solve other printing problems.

Page Rendering Mode

Increases print speed when printing is extremely slow or the print head stops during printing.

Print as Bitmap

Increases print speed when printing is extremely slow or the print head stops during printing, and other settings do not help.

Skip Blank Page

Ensures that your product does not print pages that contain no text or images.

Change Standard Resolution

Reduces the resolution of print data to correct printing problems.

Refine screening pattern

Prints graphics with a finer screening pattern.

Allow Applications to Perform ICM Color Matching

Allows applications to perform ICM color matching.

Always Use the Driver's Paper Source Setting

Prints using the paper source setting in the printer driver, rather than the setting in your application.

Output 1 page documents facedown in 2-Sided mode

Outputs single-sided pages in a 2-sided print job facedown instead of faceup.

Output documents for filing

Outputs all landscape, portrait, 1-sided, and 2-sided documents in the same orientation for easier filing.

Barcode mode

Reduces bleeding when printing barcodes on plain paper, letterhead paper, recycled paper, preprinted paper, envelopes, and thick paper.

Always Use the Driver's Color Setting

Prioritizes color settings from the printer driver software.

Reduce Print Data Size

Increases print data compression to improve print speed. Not recommended when printing fine patterns.

Print a document with both single-sided and double-sided pages

Prints an entire document that contains both single- and double-sided pages.

Parent topic: [Selecting Extended Settings - Windows](#)

Printing Your Document or Photo - Windows

Once you have selected your print settings, you are ready to save your settings and print.

1. Click **OK** to save your settings.

You see your application's Print window, such as this one:

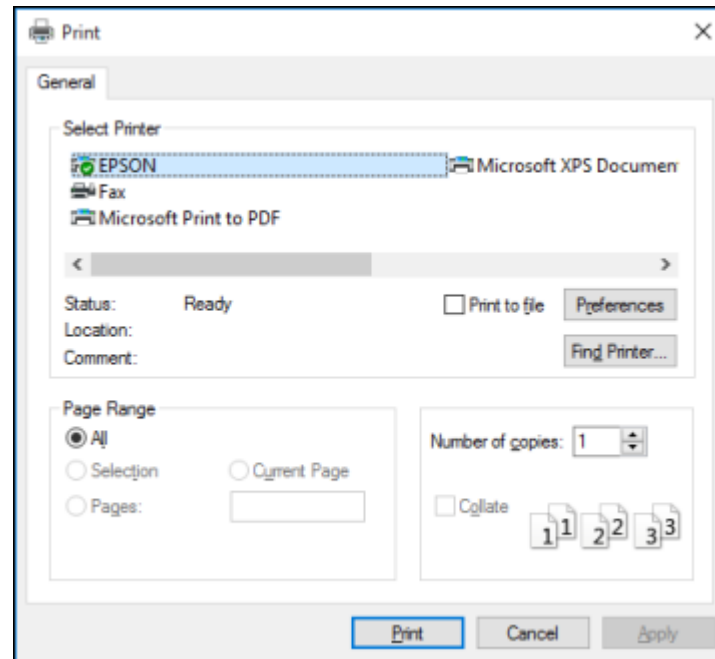

2. Click **OK** or **Print** to start printing.





Parent topic: [Printing with the Standard Epson Printer Software - Windows](#)

Locking Printer Settings - Windows

Windows administrators can lock access to some printer settings to prevent unauthorized changes.

1. Do one of the following:

- **Windows 11:** Click , search for **Settings** and select it. Select **Bluetooth & devices > Printers & scanners**. Select your product name and select **Printer properties**.

- **Windows 10:** Click  and select  (Settings) > **Devices** > **Printers & scanners**. Select your product name and select **Manage** > **Printer properties**.
 - **Windows 8.x:** Navigate to the **Apps** screen and select **Control Panel** > **Hardware and Sound** > **Devices and Printers**. Right-click your product and select **Printer properties**.
 - **Windows 7:** Click  and select **Devices and Printers**. Right-click your product and select **Printer properties**.
 - **Windows Vista:** Click  and select **Control Panel**. Click **Printer** under **Hardware and Sound**, then right-click your product and select **Properties**.
2. Click the **Optional Settings** tab.

Note: You can prevent access to the **Optional Settings** tab by changing the user or group permissions in the **Security** tab.

3. Click **Driver Settings**.

You see this window:

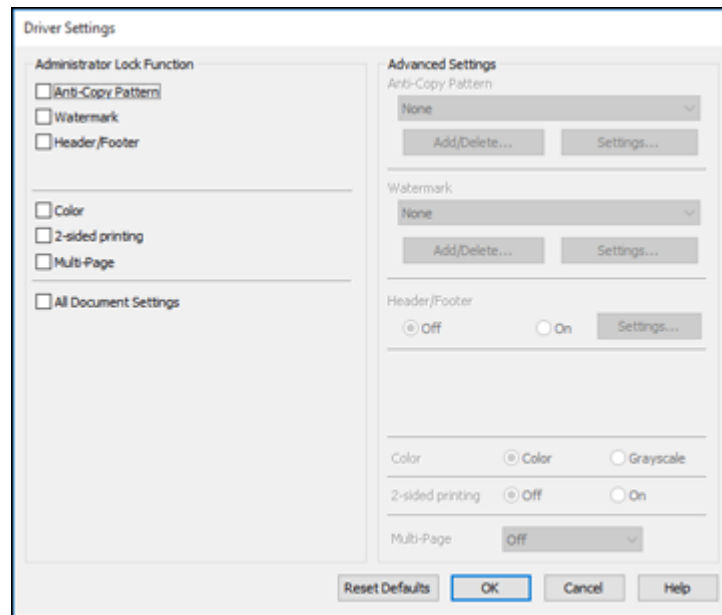

4. Select the checkbox for each setting you want to lock. To lock all print settings, select **All Document Settings**.
5. Under **Advanced Settings**, select the setting option you want to use for each locked setting.
6. Click **OK**.

[Locked Setting Options](#)

Parent topic: [Printing with the Standard Epson Printer Software - Windows](#)

Locked Setting Options

Select the options you want to use for any locked print settings.

Setting	Options	Description
Anti-Copy Pattern	Various data items	Lets you select the data to use for the pattern or prohibit anti-copy patterns
	Add/Delete	Lets you add or delete a customized anti-copy pattern
	Settings	Lets you select the arrangement, size, and other settings for the custom anti-copy pattern
Watermark	Various text watermarks	Lets you select the text for the watermark or prohibit watermarks
	Add/Delete	Lets you add or delete a customized text or image-based watermark
	Settings	Lets you select the size, position, and other watermark settings
Header/Footer	Off	Prohibits headers or footers
	On	Allows headers and footers
	Settings	Lets you select the text and position for printing headers and footers
Color	Color	Allows color printing
	Grayscale	Allows printing in black or shades of gray only
2-sided printing	Off	Allows printing on one side of the paper only
	On	Allows printing on both sides of the paper



Setting	Options	Description
Multi-Page	Off	Prohibits multi-page settings
	2-Up	Allows printing of 2 pages on one sheet of paper
	4-Up	Allows printing of 4 pages on one sheet of paper
	6-Up	Allows printing of 6 pages on one sheet of paper
	8-Up	Allows printing of 8 pages on one sheet of paper
	9-Up	Allows printing of 9 pages on one sheet of paper
	16-Up	Allows printing of 16 pages on one sheet of paper
All Document Settings	—	Lets you lock all print settings

Parent topic: [Locking Printer Settings - Windows](#)

Entering a User ID and Password for Printing

If you enabled Access Control on the product, you must enter a user ID and password in the printer driver to be able to print.

Note: If you do not know the user ID or password, contact your administrator for assistance.

1. Access the Windows Desktop and right-click the  icon for your product in the right side of the Windows taskbar, or click the up arrow and right-click . Select **Printer Settings** and click the **Maintenance** tab.

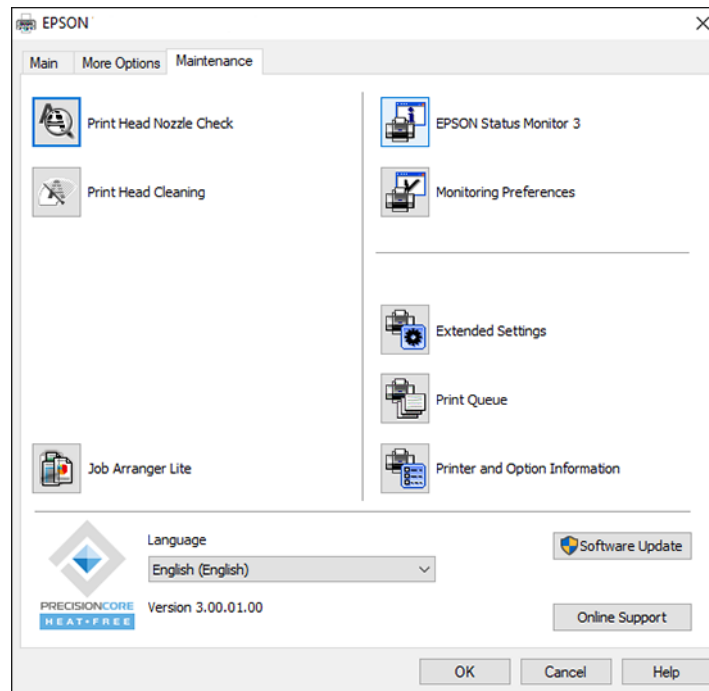



2. Click the **Printer and Option Information** button.
3. Select the **Save Access Control Settings** checkbox.
4. Click the **Settings** button.
5. Enter your user name and password.
6. Click **OK**.

Parent topic: [Printing with the Standard Epson Printer Software - Windows](#)

Selecting Default Print Settings - Windows

When you change your print settings in a program, the changes apply only while you are printing in that program session. If you want to change the print settings you use in all your Windows programs, you can select new default print settings.

1. Access the Windows Desktop and right-click the  icon for your product in the right side of the Windows taskbar, or click the up arrow and right-click .
2. Select **Printer Settings**.

You see the printer settings window:

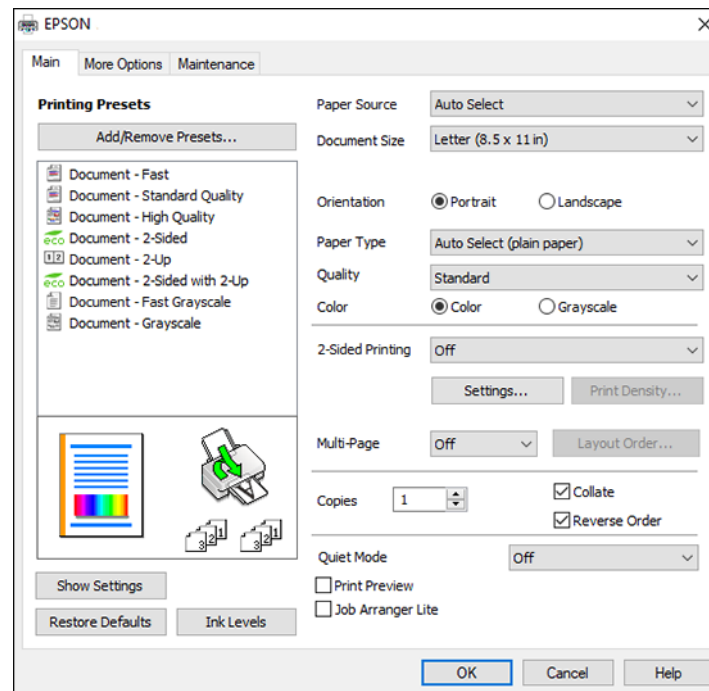

3. Select the print settings you want to use as defaults in all your Windows programs.
4. Click **OK**.



These settings are now the defaults selected for printing. You can still change them as needed for printing in any program session.

Changing the Language of the Printer Software Screens

Parent topic: [Printing with the Standard Epson Printer Software - Windows](#)

Changing the Language of the Printer Software Screens

You can change the language used on the Windows printer software screens.

1. Access the Windows Desktop and right-click the  icon for your product in the right side of the Windows taskbar, or click the up arrow and right-click .

2. Select **Printer Settings**.

You see the printer settings window.

3. Click the **Maintenance** tab.

You see the maintenance options:

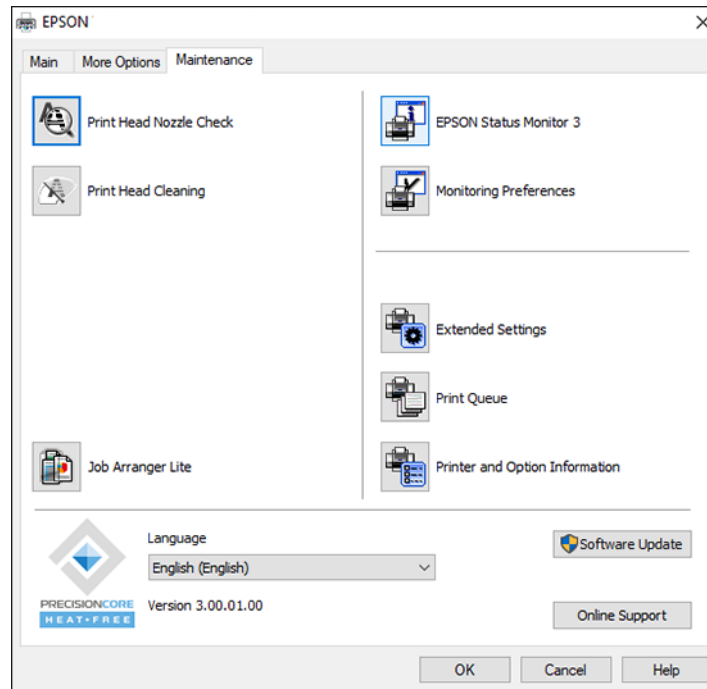

4. Select the language you want to use as the **Language** setting.



5. Click **OK** to close the printer software window.

The printer software screens appear in the language you selected the next time you access them.

Parent topic: [Selecting Default Print Settings - Windows](#)

Changing Automatic Update Options

Your printer software for Windows automatically checks for updates to the product software. You can change how often the software checks for updates or disable this feature.

1. Access the Windows Desktop and right-click the  icon for your product in the right side of the Windows taskbar, or click the up arrow and right-click .
2. Select **Software Update Settings**.

You see this window:

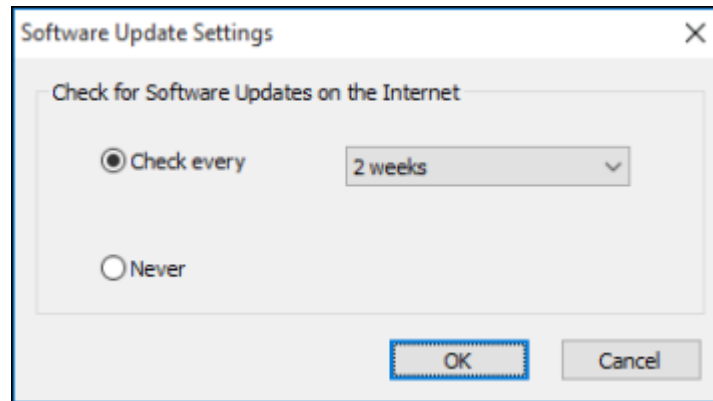

3. Do one of the following:
 - To change how often the software checks for updates, select a setting in the **Check every** menu.
 - To disable the automatic update feature, select the **Never** option.
4. Click **OK** to exit.

Note: If you choose to disable the automatic update feature, you can check for updates manually.

Parent topic: [Printing with the Standard Epson Printer Software - Windows](#)

Printing with the Built-in Epson Driver - Windows 10 S

You can print with the built-in Epson printer driver using any printing program on Windows 10 S, as described in these sections.

Note: The built-in Epson driver in Windows 10 S does not include all the available print settings for your product.

[Selecting Print Settings - Windows 10 S](#)

Parent topic: [Printing from a Computer](#)

Selecting Print Settings - Windows 10 S

Select the settings for your print job in your Windows 10 S application.

1. Open a photo or document for printing.
2. Select the print command in your application.

Note: You may need to select a print icon on your screen, the **Print** option in the **File** menu, or another command. See your application's help utility for details.

3. If necessary, select your product name as the printer you want to use.

Note: You may also need to select **Properties** or **Preferences** to view your print settings.

You see a window like this:

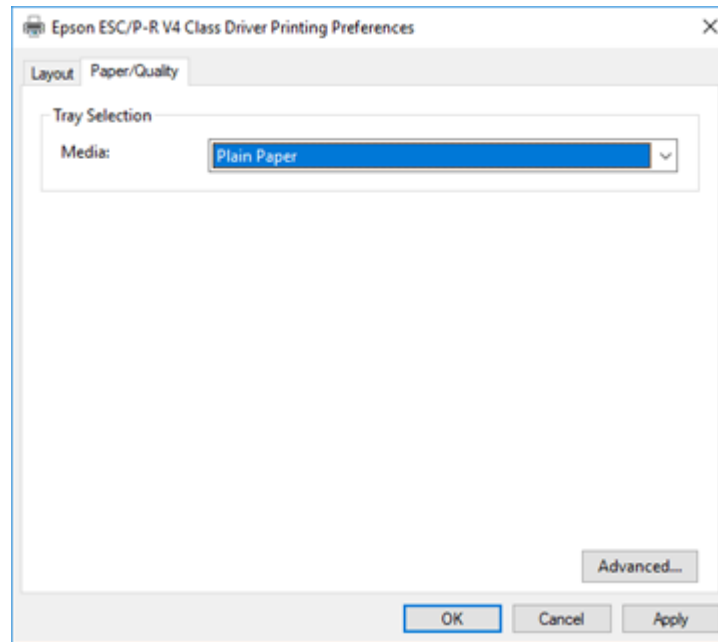

4. Select the type of paper you loaded as the **Media** setting.

Note: The setting may not exactly match the name of your paper. Check the paper type settings list for details.

5. Click the **Advanced** button.

You see a window like this:

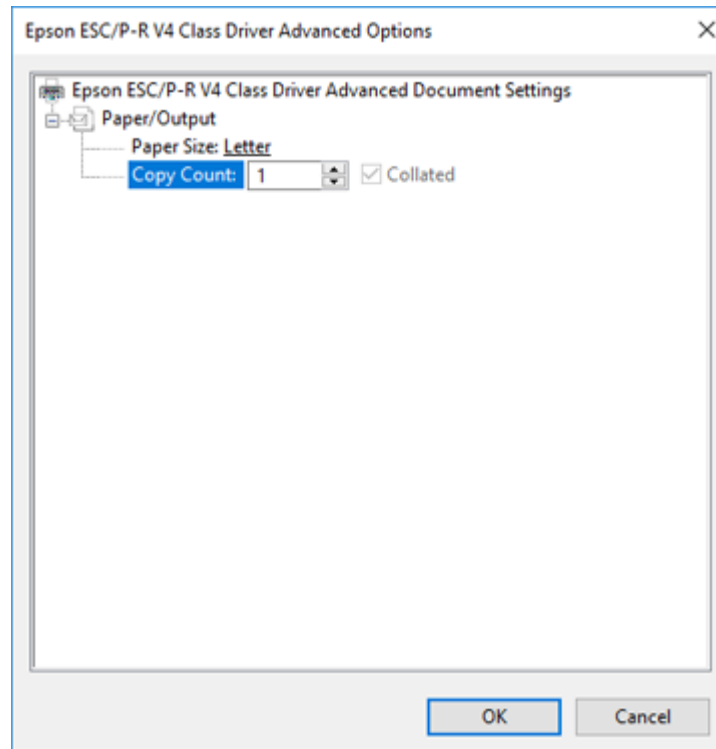

6. Select the size of the paper you loaded as the **Paper Size** setting.
7. To print multiple copies, select or enter the number as the **Copy Count** setting.
8. To print multiple copies of multi-page documents in sets, select the **Collated** checkbox.
9. Click **OK**.

You return to the printing preferences window.

10. Select the **Layout** tab.

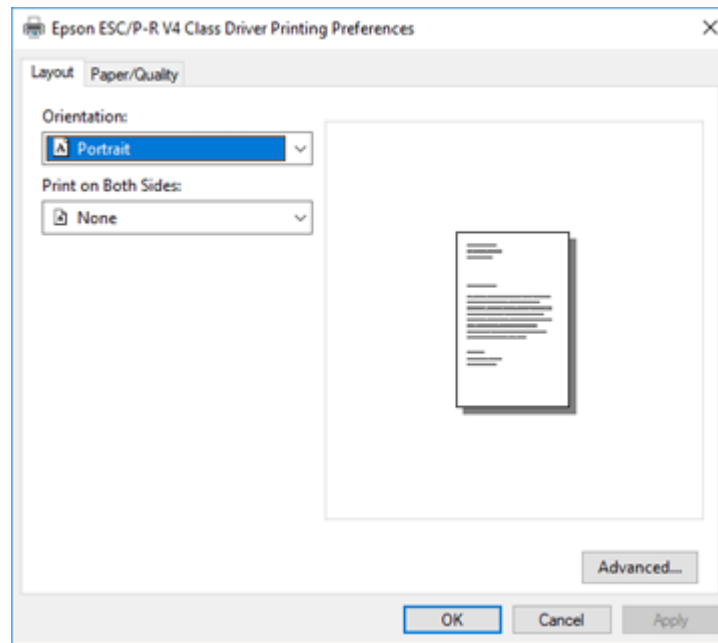

11. Select the orientation of your document as the **Orientation** setting.

- To print double-sided, select one of the **Print on Both Sides** options, depending on how you want to orient the page layout. The icon next to each option shows the layout.

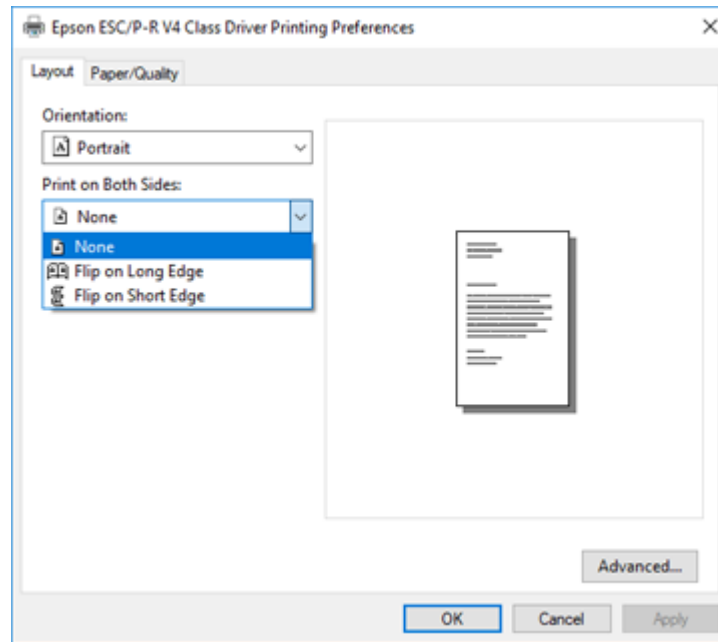

- Click **OK** to save your settings.

You see your application's **Print** window.

- Click **OK** or **Print** to start printing.

Parent topic: [Printing with the Built-in Epson Driver - Windows 10 S](#)

Printing with the Epson Standard Printer Software - Mac

You can print with your product using any Mac printing program, as described in these sections.

Note: If you have an Internet connection, it is a good idea to check for updates to your product software on Epson's support website or using Epson Software Updater.

[Selecting Basic Print Settings - Mac](#)

[Selecting Page Setup Settings - Mac](#)

[Selecting Print Layout Options - Mac](#)

[Selecting Double-sided Printing Settings - Mac](#)

[Selecting Printing Preferences - Mac](#)

[Printing Your Document or Photo - Mac](#)

Parent topic: [Printing from a Computer](#)

Selecting Basic Print Settings - Mac

Select the basic settings for the document or photo you want to print.

1. Open a photo or document for printing.
2. Select the print command in your application.

Note: You may need to select a print icon on your screen, the **Print** option in the File menu, or another command. See your application's help utility for details.

3. Select your product as the **Printer** setting.

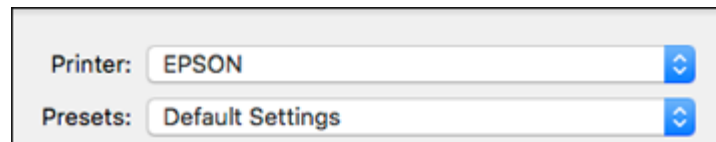

4. If necessary, click the arrow next to the Printer setting or the **Show Details** button to expand the print window.

You see the expanded printer settings window for your product:

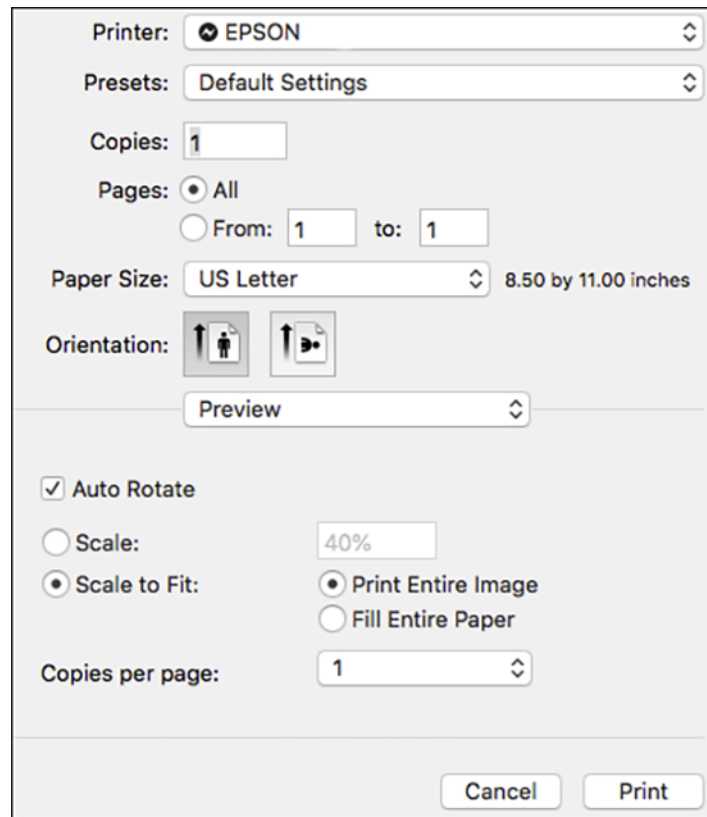

Note: The print window may look different, depending on the Mac OS version and the application you are using.

5. To use an existing set of print settings, select **Presets** and choose a preset from the list.
6. Select the **Copies** and **Pages** settings as necessary.

Note: If you do not see these settings in the print window, check for them in your application before printing.

7. Select the page setup options: **Paper Size** and **Orientation**.

Note: If you do not see these settings in the print window, check for them in your application before printing. They may be accessible by selecting **Page Setup** from the File menu.

8. Select any application-specific settings that appear on the screen, such as those shown in the image above for the Preview application.
9. Select **Print Settings** or **Printer Features** from the pop-up menu.

You see these settings:

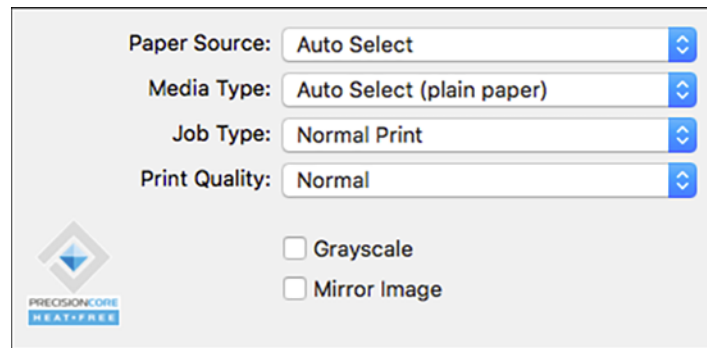

Note: The available print settings and appearance of the print window may be different than those covered here, depending on the Mac OS version and the application you are using.

10. Select the **Paper Source** you wish to print from.
11. Select the type of paper you loaded as the **Media Type** setting.

Note: The setting may not exactly match the name of your paper. Check the paper type settings list for details.

12. Change the **Job Type** setting if you want to save the file to the product's hard drive.
13. Select the **Print Quality** setting you want to use.
14. Select any of the available print options.

15. If you want to save your settings as a new printing preset, select **Presets** and then select **Save current settings as Preset**.

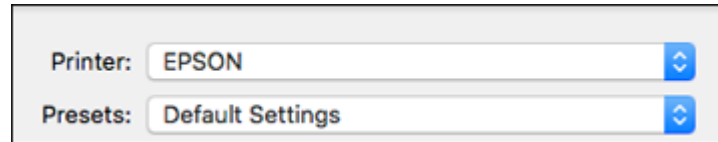

[Paper Source Options - Mac](#)

[Print Quality Options - Mac](#)

Parent topic: [Printing with the Epson Standard Printer Software - Mac](#)

Related references

[Paper or Media Type Settings - Printing Software](#)

Related tasks

[Selecting Page Setup Settings - Mac](#)

Paper Source Options - Mac

You can select any of the available options in the Paper Source menu to print on the paper loaded in that source.

Auto Select

Automatically selects the paper source based on the selected paper size.

Paper Tray

Selects the paper in the rear feed as the paper source.

Cassette 1

Selects the paper in cassette 1 as the paper source.

Cassette 2

Selects the paper in cassette 2 as the paper source.

Cassette 3

Selects the paper in cassette 3 as the paper source.

Cassette 4

Selects the paper in cassette 4 as the paper source.

Parent topic: [Selecting Basic Print Settings - Mac](#)

Print Quality Options - Mac

You can select any of the available Print Quality options to fine-tune the quality of your print. Some settings may be unavailable, depending on the paper type setting you have chosen.

Draft

For draft printing on plain paper.

Normal

For everyday text and image printing.

Fine

For text and graphics with good quality and print speed.

Best Quality

For the best print quality, but the slowest print speed.

Parent topic: [Selecting Basic Print Settings - Mac](#)

Selecting Page Setup Settings - Mac

Depending on your application, you may be able to select the paper size and orientation settings from the print window.

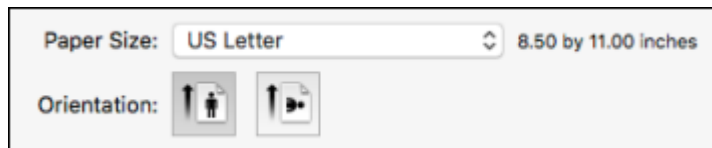

Note: If you do not see these settings in the print window, check for them in your application before printing. They may be accessible by selecting **Page Setup** from the File menu.

1. Select the size of the paper you loaded as the **Paper Size** setting.
2. Select the orientation of your document or photo as shown in the print window.

Note: If you are printing an envelope, select the  icon.

Note: You can reduce or enlarge the size of the printed image by selecting **Paper Handling** from the pop-up menu and selecting a scaling option.

Parent topic: [Printing with the Epson Standard Printer Software - Mac](#)

Selecting Print Layout Options - Mac

You can select a variety of layout options for your document or photo by selecting **Layout** from the pop-up menu on the print window.

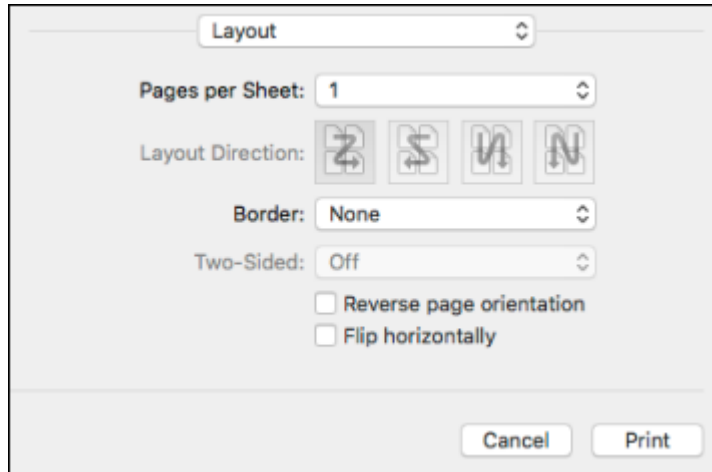

- To print multiple pages on one sheet of paper, select the number of pages in the **Pages per Sheet** pop-up menu. To arrange the print order of the pages, select a **Layout Direction** setting.
- To print borders around each page on the sheet, select a line setting from the **Border** pop-up menu.
- To print on both sides of each page, select a setting from the **Two-Sided** pop-up menu.
- To invert or flip the printed image, select the **Reverse page orientation** or **Flip horizontally** settings.

Parent topic: [Printing with the Epson Standard Printer Software - Mac](#)

Selecting Double-sided Printing Settings - Mac

You can print on both sides of the paper by selecting **Two-sided Printing Settings** from the pop-up menu on the print window.

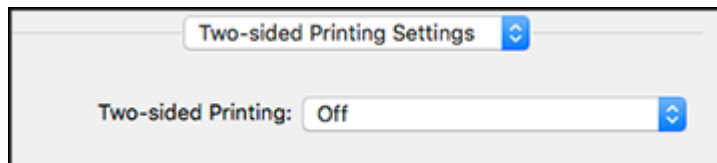

Note: Some options may be pre-selected or unavailable, depending on other settings you have chosen or if you are accessing the product over a network. This screen may be different, depending on the Mac OS version you are using.

1. Select one of the **Two-sided Printing** options.
2. Select the type of document you are printing as the **Document Type** setting. The software automatically sets the Adjustments options for that document type.

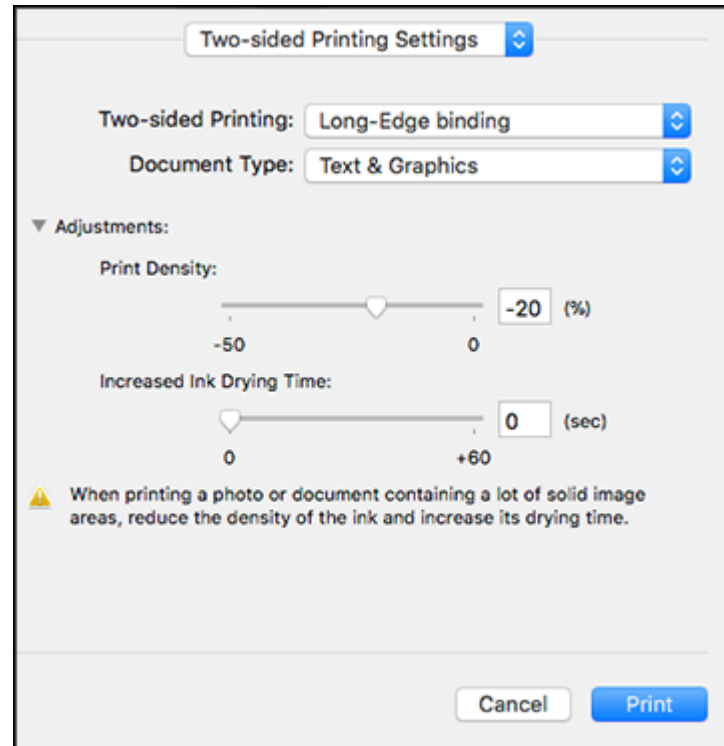

3. If necessary, customize the Adjustments settings as instructed on the screen.
4. Print a test copy of your double-sided document to test the selected settings.
5. Follow any instructions displayed on the screen during printing.

[Double-sided Printing Options and Adjustments - Mac](#)

Parent topic: [Printing with the Epson Standard Printer Software - Mac](#)

Related references

[Double-sided Printing Capacity](#)

Double-sided Printing Options and Adjustments - Mac

You can select any of the available options in the **Two-sided Printing Settings** pop-up menu to set up your double-sided print job.

Long-Edge binding

Orients double-sided printed pages to be bound on the long edge of the paper.

Short-Edge binding

Orients double-sided printed pages to be bound on the short edge of the paper.

Print Density

Sets the level of ink coverage for double-sided printing.

Increased Ink Drying Time

Sets the amount of time required for drying ink after printing on one side of the paper before printing the other side in double-sided printing.

Parent topic: [Selecting Double-sided Printing Settings - Mac](#)

Selecting Printing Preferences - Mac

You can select printing preferences that apply to all the print jobs you send to your product.

1. In the Apple menu or the Dock, select **System Preferences** or **System Settings**.
2. Select **Print & Fax**, **Print & Scan**, or **Printers & Scanners**, select your product, and select **Options & Supplies**.
3. Select **Driver** or **Options**.

You see a screen like this:

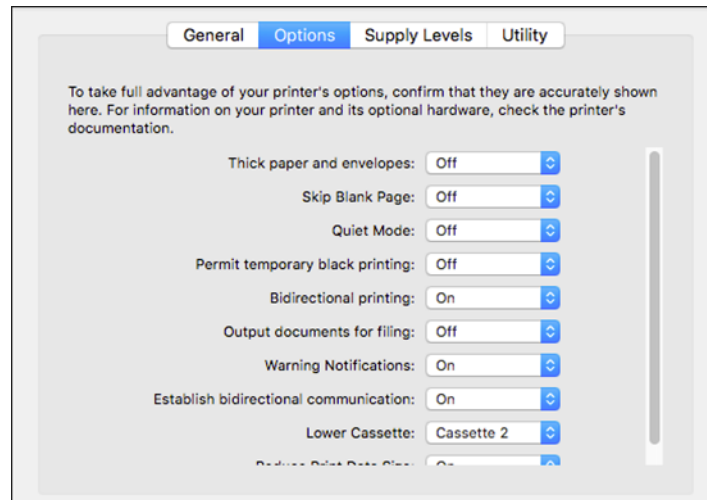

Note: The available settings and appearance of the options window may be different than those covered here, depending on the Mac OS version and the application you are using.

4. Select any of the available printing preferences.
5. Click **OK**.

[Printing Preferences - Mac](#)

Parent topic: [Printing with the Epson Standard Printer Software - Mac](#)

Printing Preferences - Mac

You can select these settings on the **Options** or **Driver** tab.

Thick Paper and Envelopes

Prevents ink from smearing when you print on envelopes or other thick paper.

Skip Blank Page

Ensures that your product does not print pages that contain no text or images.

Quiet Mode

Lessens noise during printing but may decrease print speed.

Permit temporary black printing

Allows you to print using black ink when color ink is expended.

Bidirectional printing

Prints in both directions (right-to-left and left-to-right), speeding up printing, but may reduce print quality.

Output documents for filing

Outputs all landscape, portrait, 1-sided, and 2-sided documents in the same orientation for easier filing.

Warning Notifications

Lets you choose whether or not to receive warning notifications from the printer software for various operating conditions.

Establish bidirectional communication

Allows the product to communicate with the computer. Do not change the default setting unless you experience issues when using a shared printing pool.

Reduce Print Data Size

Increases print data compression to improve print speed. Not recommended when printing fine patterns.

Lower Cassette

Specifies whether the optional cassette is present.

Parent topic: [Selecting Printing Preferences - Mac](#)

Printing Your Document or Photo - Mac

Once you have selected your print settings, you are ready to print.

Click **Print** at the bottom of the print window.

[Checking Print Status - Mac](#)

Parent topic: [Printing with the Epson Standard Printer Software - Mac](#)



Checking Print Status - Mac

During printing, you can view the progress of your print job, control printing, and check ink status.

1. Click the printer icon when it appears in the Dock.

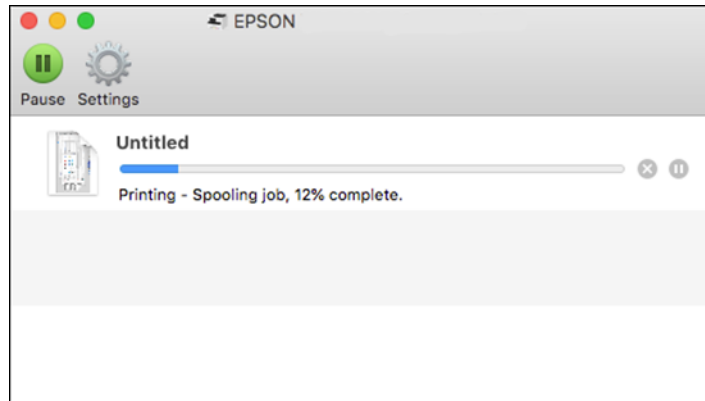
You see the print status window:



2. Select the following options as necessary for your Mac OS version:
 - To cancel printing, click the print job and click  or **Delete**.
 - To pause a print job, click the print job and click  or **Hold**. To resume a print job, click the paused print job and click  or **Resume**.
 - To pause printing for all queued print jobs, click **Pause** or **Pause Printer**.
 - To display other printer information, click **Settings** or **Supply Levels**.

Parent topic: [Printing Your Document or Photo - Mac](#)

Setting Up Printing on a Chromebook

Your Epson printer supports native printing on Chromebook, allowing you to print from a Chromebook without drivers or cables.

For directions on setting up your printer, visit [Setting Up Your Epson Printer on Your Chromebook \(U.S.\)](#) or [Setting Up Your Epson Printer on Your Chromebook \(Canada\)](#).

For Latin America, visit [Setting Up Your Epson Printer on Your Chromebook](#).

Parent topic: [Product Basics](#)

[Printing from a Computer](#)

Related topics

[Wi-Fi or Wired Networking](#)

Printing from a Smartphone or Tablet

You can print from a smartphone or tablet running iOS or Android using the Epson Smart Panel app.

Note: Your device must be connected to the same wireless network as your Epson product, and Epson Smart Panel must be configured for use with your product.

1. Download the Epson Smart Panel app from your device's app store or from Epson's website. See the link below.
2. Open the Epson Smart Panel app and select a print menu on the home screen.
3. Follow the on-screen instructions to begin printing.

Parent topic: [Printing from a Computer](#)

Related tasks

[Using the Epson Smart Panel Mobile App](#)

Printing with the PCL Printer Software - Windows

You can print with the PCL printer software using any Windows printing program, as described in these sections (WF-C5890).

[Synchronizing Printer Settings - PCL Driver - Windows](#)

[Selecting Basic Print Settings - PCL Driver - Windows](#)



[Selecting Default Print Settings - PCL Driver - Windows](#)



[Locking Printer Settings - PCL Driver - Windows](#)

Parent topic: [Printing from a Computer](#)

Synchronizing Printer Settings - PCL Driver - Windows

You may need to synchronize the printer driver with the product if the printer driver does not detect the correct information or settings from the product.

1. Do one of the following:
 - **Windows 11:** Click , search for **Settings** and select it. Select **Bluetooth & devices > Printers & scanners**. Select the PCL driver, then select **Printer properties**.
 - **Windows 10:** Click , and select  (Settings) > **Devices > Printers & scanners**. Select the PCL driver, and select **Manage > Printer properties**.

- **Windows 8.x:** Navigate to the **Apps** screen and select **Control Panel > Hardware and Sound > Devices and Printers**. Right-click on your product, select the PCL option, and select **Printer properties**.
 - **Windows 7:** Click  and select **Devices and Printers**. Right-click on your product, select the PCL option, and select **Printer properties**.
 - **Windows Vista:** Click  and select **Control Panel**. Click **Printer** under **Hardware and Sound**, then right-click on your product, select the PCL option, and select **Properties**.
2. Click the **Optional Settings** tab.
You see a window like this:

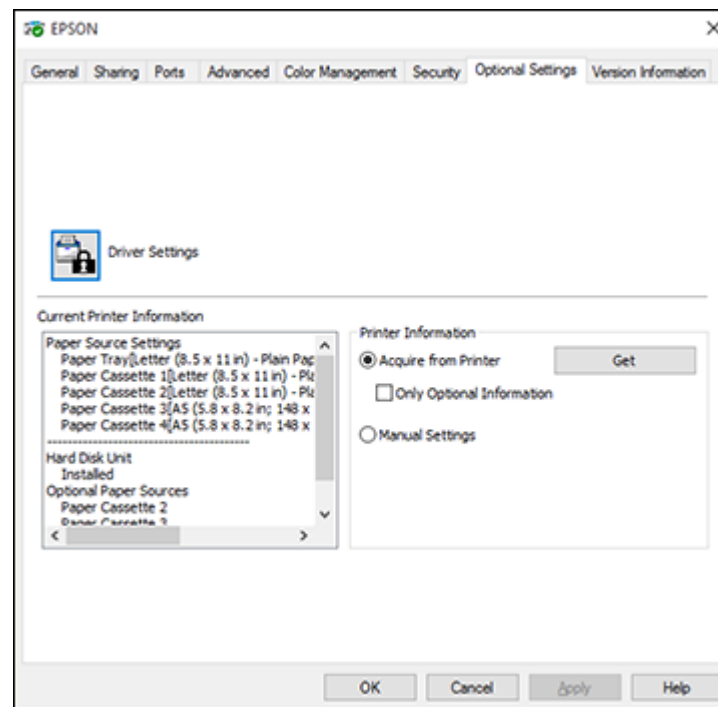

3. Make sure **Acquire from Printer** is selected and click **Get**.
The product's settings and other information appears in the Current Printer Information area.
4. Click **OK**.

Parent topic: [Printing with the PCL Printer Software - Windows](#)

Selecting Basic Print Settings - PCL Driver - Windows

Select the basic settings for the document or photo you want to print.

Note: The names of settings on the PCL driver screens may vary slightly, depending on the version of the driver you have installed.

1. Open a photo or document for printing.
2. Select the print command in your application.

Note: You may need to select a print icon on your screen, the **Print** option in the **File** menu, or another command. See your application's help utility for details.

3. If necessary, select the PCL option of your product as the printer you want to use.

Note: You may also need to select **Properties** or **Preferences** to view your print settings.

You see the **Main** tab of your printer settings window:

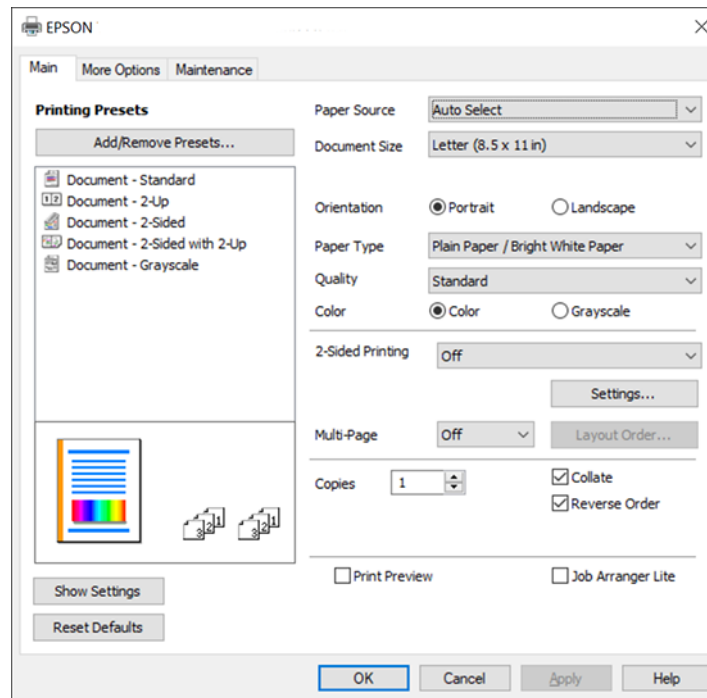

Note: For more information about a setting, right-click it and select **Help**.

4. For the **Paper Source** setting, select where you loaded the paper you want to print on.
5. Select the size of the paper you loaded as the **Document Size** setting.

Note: You can also select the **User-Defined** setting to create a custom paper size.

6. Select the orientation of your document.

Note: If you are printing an envelope, select **Landscape**.

7. Select the type of paper you loaded as the **Paper Type** setting.

Note: The setting may not exactly match the name of your paper. Check the paper type settings list for details.

8. Select any of the available print options.
9. To select a variety of additional layout and printing options for your document or photo, select the **More Options** tab and select the printing options you want.
10. To select maintenance and other optional settings, select the **Maintenance** tab and select the options you want.





Parent topic: [Printing with the PCL Printer Software - Windows](#)

Related references

[Paper or Media Type Settings - Printing Software](#)

Selecting Default Print Settings - PCL Driver - Windows

When you change your print settings in a program, the changes apply only while you are printing in that program session. If you want to change the print settings you use in all your Windows programs, you can select new default print settings.

1. Do one of the following:
 - **Windows 11:** Click , search for **Settings** and select it. Select **Bluetooth & devices > Printers & scanners**. Right-click on your product, select the PCL option, and select **Printer properties**.
 - **Windows 10:** Click  and select  (Settings) > **Devices > Printers & scanners**. Right-click on your product, select the PCL option, and select **Manage > Printing preferences**.
 - **Windows 8.x:** Navigate to the **Apps** screen and select **Control Panel > Hardware and Sound > Devices and Printers**. Right-click on your product, select the PCL option, and select **Printing preferences**.
 - **Windows 7:** Click  and select **Devices and Printers**. Right-click on your product, select the PCL option, and select **Printing preferences**.
 - **Windows Vista:** Click  and select **Control Panel**. Click **Printer** under **Hardware and Sound**, then right-click on your product, select the PCL option, and select **Properties**.

You see the printer settings window:

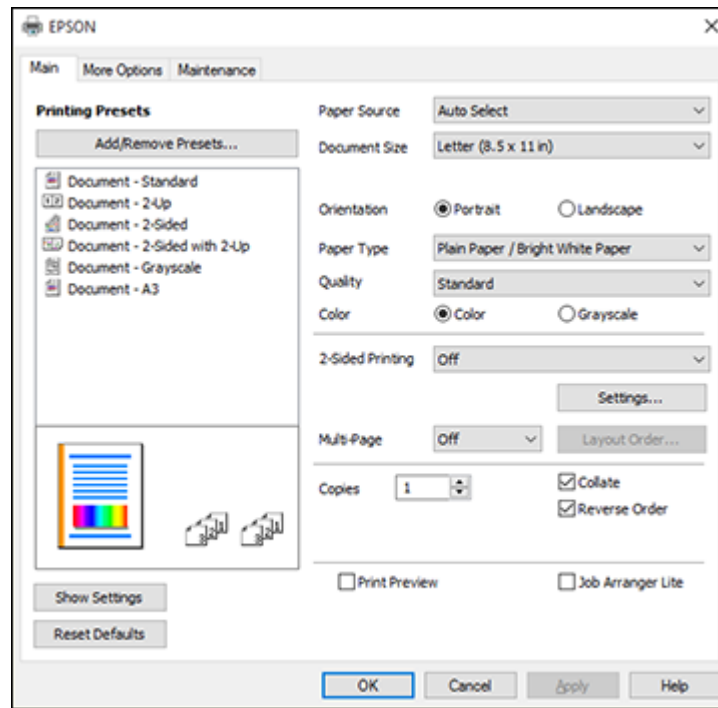

Note: For more information about a setting, right-click it and select **Help**.





2. Select the print settings you want to use as defaults in all your Windows programs.
3. Click **OK**.

These settings are now the defaults selected for printing. You can still change them as needed for printing in any program session.

Parent topic: [Printing with the PCL Printer Software - Windows](#)

Locking Printer Settings - PCL Driver - Windows

Administrators can lock some printer settings to prevent unauthorized changes.

1. Do one of the following:
 - **Windows 11:** Click , search for **Settings** and select it. Select **Bluetooth & devices > Printers & scanners**. Right-click on your product, select the PCL option, and select **Printer properties**.
 - **Windows 10:** Click  and select  (Settings) > **Devices > Printers & scanners**. Right-click on your product, select the PCL option, and select **Manage > Printer properties**.
 - **Windows 8.x:** Navigate to the **Apps** screen and select **Control Panel > Hardware and Sound > Devices and Printers**. Right-click on your product, select the PCL option, and select **Printer properties**.
 - **Windows 7:** Click  and select **Devices and Printers**. Right-click on your product, select the PCL option, and select **Printer properties**.
 - **Windows Vista:** Click  and select **Control Panel**. Click **Printer** under **Hardware and Sound**, then right-click on your product, select the PCL option, and select **Properties**.
2. Click the **Optional Settings** tab.
3. Click **Driver Settings**.

You see this window:

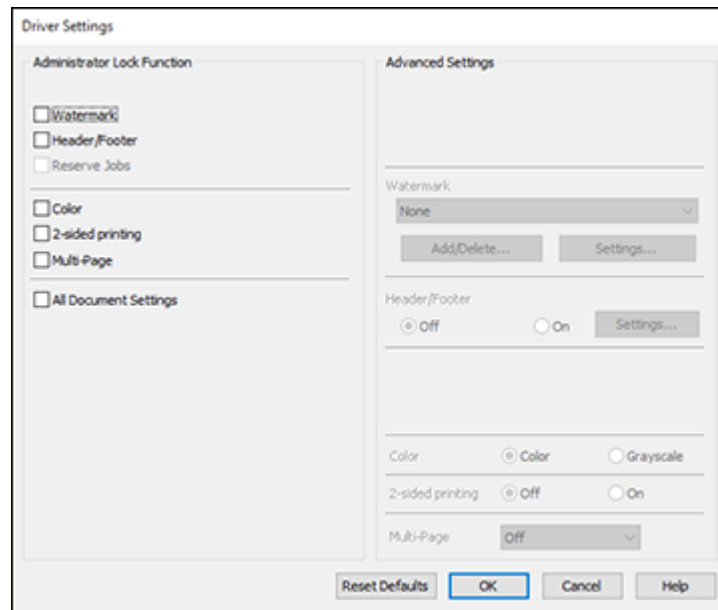

4. Select the checkbox for the settings you want to lock. To lock all print settings, select **All Document Settings**.
5. Under **Advanced Settings**, select the setting option you want to use for each locked setting.
6. Click **OK**.

[PCL Driver Locked Setting Options](#)

Parent topic: [Printing with the PCL Printer Software - Windows](#)

PCL Driver Locked Setting Options

Select the options you want to use for any locked print settings.

Setting	Options	Description
Watermark	Various text watermarks	Lets you select the text for the watermark or prohibit watermarks
	Add/Delete	Lets you add or delete a customized text or image-based watermark
	Settings	Lets you select the size, position, and other watermark settings
Header/Footer	Off	Prohibits headers or footers
	On	Allows headers and footers
	Settings	Lets you select the text and position for printing headers and footers
Color	Color	Allows color printing
	Grayscale	Allows printing in black or shades of gray only
2-sided printing	Off	Allows printing on only one side of the paper
	On	Allows printing on both sides of the paper

Setting	Options	Description
Multi-Page	Off	Prohibits multi-page settings
	2-Up	Allows printing of 2 pages on one sheet of paper
	4-Up	Allows printing of 4 pages on one sheet of paper
	6-Up	Allows printing of 6 pages on one sheet of paper
	8-Up	Allows printing of 8 pages on one sheet of paper
	9-Up	Allows printing of 9 pages on one sheet of paper
	16-Up	Allows printing of 16 pages on one sheet of paper

Parent topic: [Locking Printer Settings - PCL Driver - Windows](#)

Printing with the PostScript (PS3) Printer Software - Windows

You can print with the PostScript (PS3) printer software using any Windows printing program, as described in these sections (WF-C5890).

[Selecting Print Settings - PostScript Printer Software - Windows](#)

[Selecting Default Print Settings - PostScript Printer Software - Windows](#)

Parent topic: [Printing from a Computer](#)

Selecting Print Settings - PostScript Printer Software - Windows

Select the basic settings for the document or photo you want to print.

1. Open a photo or document for printing.
2. Select the print command in your application.

Note: You may need to select a print icon on your screen, the **Print** option in the **File** menu, or another command. See your application's help utility for details.

3. If necessary, select your product name as the printer you want to use, and then click the **Preferences** or **Properties** button, depending on the application.

You see the Paper/Quality tab of your printer settings window:

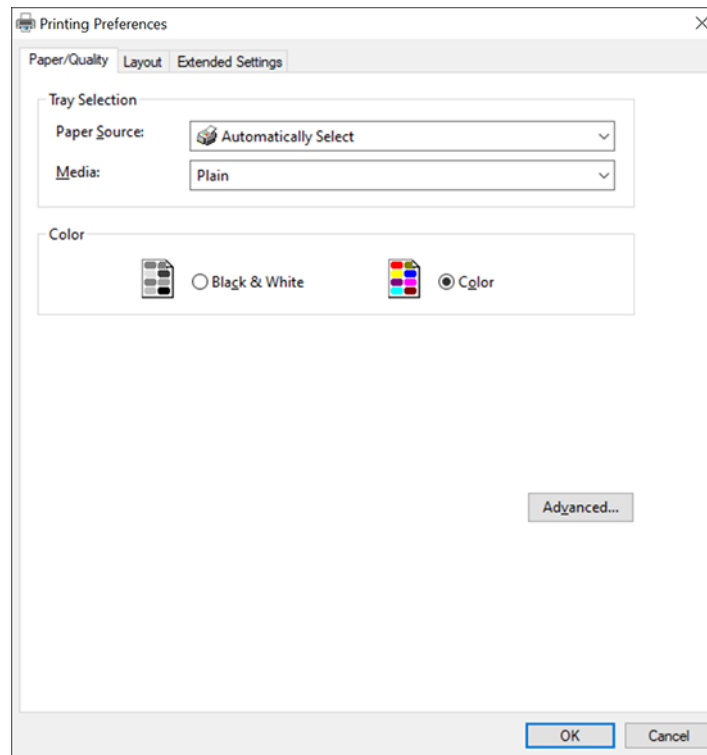

4. Select the **Paper Source** that matches where you loaded the paper you want to print on.
5. Select **Plain** as the **Media** setting.
6. Select one of the following as the Color setting:
 - To print text and graphics in black only, select the **Black & White** setting.
 - To print a color document or photo, select the **Color** setting.
7. To select additional PostScript layout and printing options, select **Advanced** and select additional settings as necessary.
8. Select the **Layout** tab.

You see a screen like this:

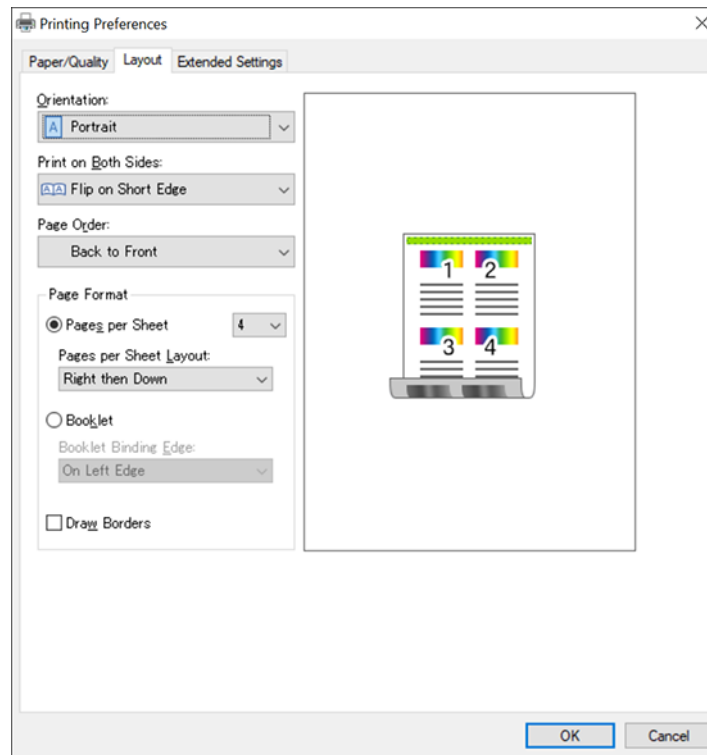





9. Select any settings as necessary.
10. If you have set up Access Control or want to print a confidential job, select **Extended Settings** to enable printing by entering a user name and password , or print a confidential job by entering the necessary information.

Parent topic: [Printing with the PostScript \(PS3\) Printer Software - Windows](#)

Selecting Default Print Settings - PostScript Printer Software - Windows

When you change your print settings in a program, the changes apply only while you are printing in that program session. If you want to change the print settings you use in all your Windows programs, you can select new default print settings.

1. Do one of the following:

- **Windows 11:** Click , search for **Settings** and select it. Select **Bluetooth & devices > Printers & scanners**. Right-click on your product and select **Printer properties**.
- **Windows 10:** Click  and select  (Settings) > **Devices > Printers & scanners**. Select your product name and select **Manage > Printing preferences**.
- **Windows 8.x:** Navigate to the **Apps** screen and select **Control Panel > Hardware and Sound > Devices and Printers**. Right-click your product name and select **Print Preferences**.
- **Windows 7:** Click  and select **Devices and Printers**. Right-click your product name and select **Printing Preferences**.
- **Windows Vista:** Click  and select **Control Panel**. Click **Printer** under **Hardware and Sound**, right-click your product name, and select **Printing Preferences**.

You see the printer settings window:

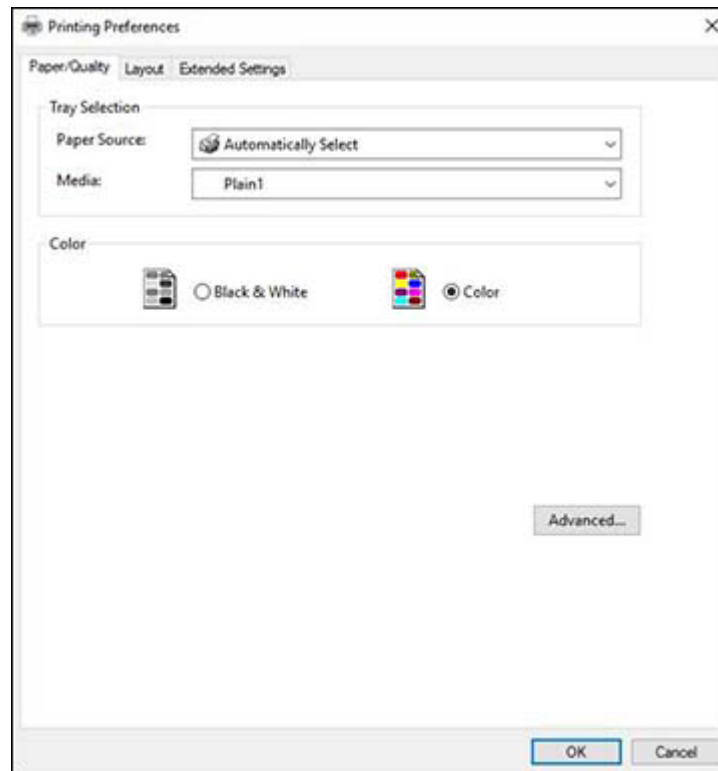

2. Select the print settings you want to use as defaults in all your Windows programs.
3. Click **OK**.

These settings are now the defaults selected for printing. You can still change them as needed for printing in any program session.

Parent topic: [Printing with the PostScript \(PS3\) Printer Software - Windows](#)

Printing with the PostScript (PS3) Printer Software - Mac

You can print with the PostScript (PS3) printer software using any Mac printing program, as described in these sections (WF-C5890).

[Selecting Basic Print Settings - PostScript Printer Software - Mac](#)

Parent topic: [Printing from a Computer](#)

Selecting Basic Print Settings - PostScript Printer Software - Mac

Select the basic settings for the document or photo you want to print.

The PostScript printer software supports plain paper printing on these paper and envelope sizes:

- A4 (8.3 × 11.7 inches [210 × 297 mm])
- Letter (8.5 × 11 inches [216 × 279 mm])
- No. 10 (4.1 × 9.5 inches [105 × 241 mm])
- A6 (4.1 × 5.8 inches [105 × 148 mm])
- B6 (5 × 7.2 inches [128 × 182 mm])
- Executive (7.25 × 10.5 inches [184 × 267 mm])
- Legal (8.5 × 14 inches [216 × 356 mm])

1. Open a photo or document for printing.
2. Select the print command in your application.

Note: You may need to select a print icon on your screen, the **Print** option in the **File** menu, or another command. See your application's help utility for details.

3. Select your product as the **Printer** setting.

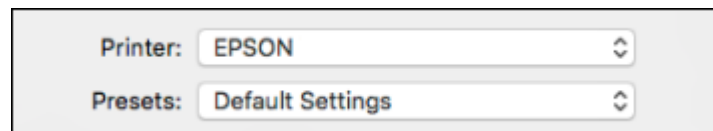

4. If necessary, click the arrow next to the Printer setting or the **Show Details** button to expand the print window.

You see the expanded printer settings window for your product:

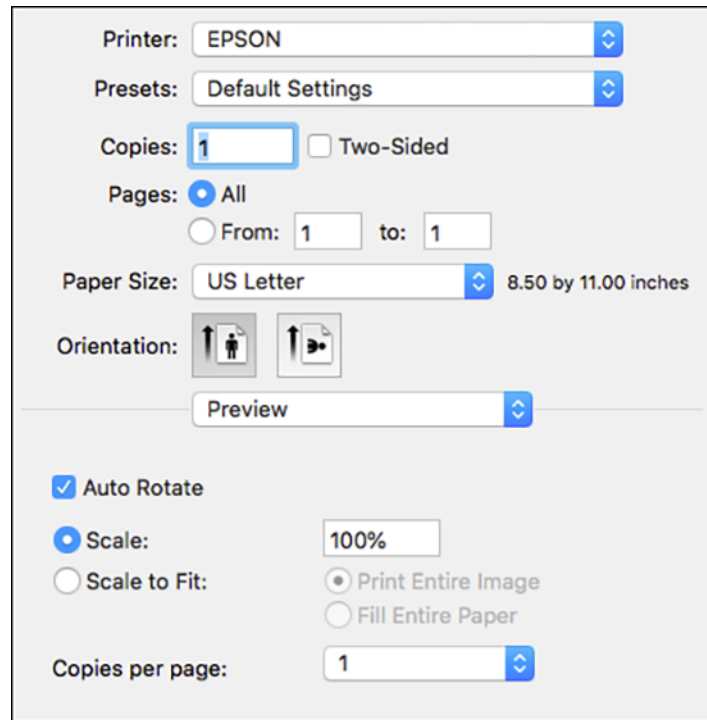

Printer: EPSON

Presets: Default Settings

Copies: 1 Two-Sided

Pages: All
 From: 1 to: 1

Paper Size: US Letter 8.50 by 11.00 inches

Orientation: Portrait Landscape

Preview

Auto Rotate

Scale: 100%

Scale to Fit: Print Entire Image
 Fill Entire Paper

Copies per page: 1

Note: The print window may look different, depending on the Mac OS version and the application you are using.

5. Select the **Two-Sided**, **Copies**, and **Pages** settings as necessary.

Note: If you do not see these settings in the print window, check for them in your application before printing.

6. Select the page setup options: **Paper Size** and **Orientation**.

Note: If you do not see these settings in the print window, check for them in your application before printing. They may be accessible by selecting **Page Setup** from the File menu.

7. Select any application-specific settings that appear on the screen, such as those shown in the image above for the Preview application.
8. Select **Paper Feed** from the pop-up menu.

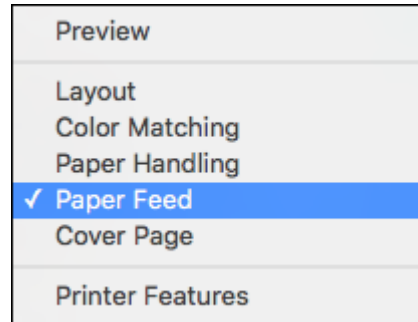

You see these settings:

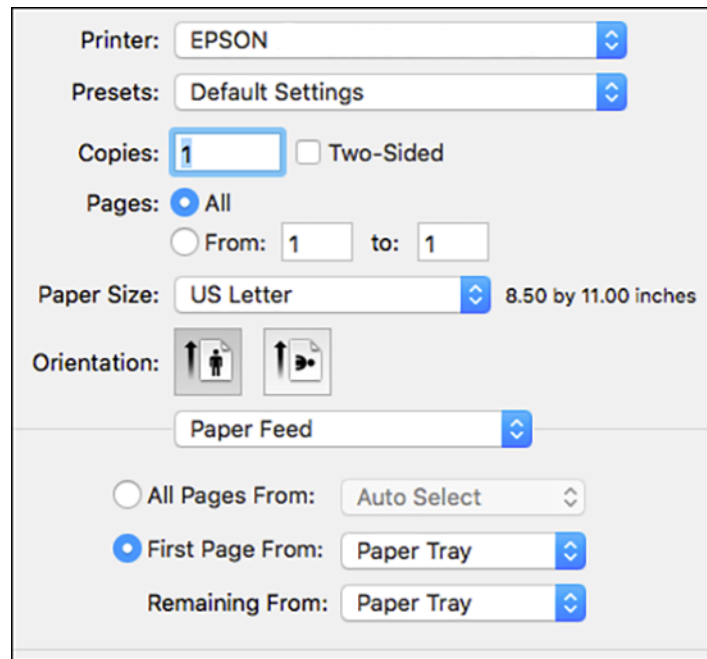

9. Select **All Pages From** or **First Page From** and select the paper source you want to print from.
10. Select **Printer Features** from the pop-up menu.

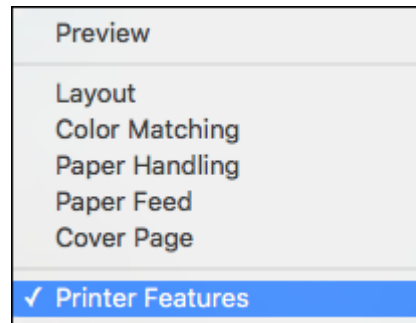

You see these settings:

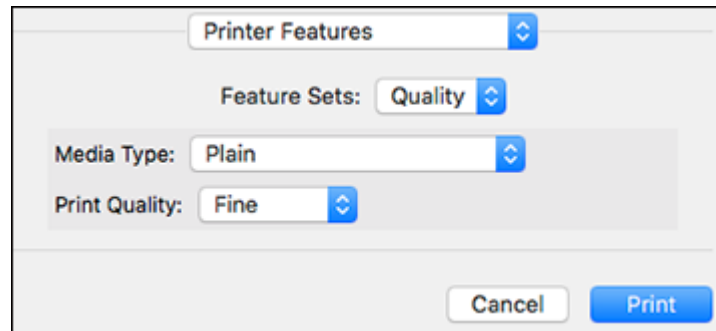

11. Select **Plain** as the **Media Type** setting.
12. Select one of the following **Print Quality** options:
 - For fast printing with reduced quality, select **Fast**.
 - For printing text and graphics with good quality and print speed, select **Fine**.
 - For the best printing with reduced speed, select **Maximum**.
13. Select **Color >** from the Feature Sets pop-up menu.

14. Select a **Color Mode** option:

- To print a color document or photo, select the **Color** setting.
- To print text and graphics in black only, select the **Monochrome** setting.

15. Select any of the following from the pop-up menu as necessary:

- Select **Layout** to adjust a variety of layout options for your document or photo.
- Select **Paper Handling** to adjust the size of the image as you print it.
- Select **Color Matching** to fine-tune the colors in your printout.

Parent topic: [Printing with the PostScript \(PS3\) Printer Software - Mac](#)

Cancelling Printing Using a Product Button

If you need to cancel printing, press the  cancel button.

Parent topic: [Printing from a Computer](#)

Scanning

You can scan your originals and save them as digital files.

[Starting a Scan](#)

[Scanning in Epson Scan 2](#)

[Scanning with Document Capture Pro or Document Capture](#)

[Entering a User ID and Password for Scanning](#)

Starting a Scan

After placing your originals on your product for scanning, start scanning using one of these methods.

[Starting a Scan Using the Product Control Panel](#)

[Setting Up and Scanning to a Network Folder or FTP Server](#)

[Starting a Scan Using the Epson Scan 2 Icon](#)

[Starting a Scan from a Scanning Program](#)

[Starting a Scan from a Smartphone or Tablet](#)

Parent topic: [Scanning](#)

Starting a Scan Using the Product Control Panel

You can scan an image to a variety of destinations using your product's control panel.

1. Make sure you installed the product software and connected the product to your computer or network.

Note: Restart your computer after installing the product software to enable scanning from the control panel.

2. Place your original on the product for scanning.

Note: To scan a double-sided or multi-page document, place your originals in the ADF.

3. Press the  home button, if necessary.
4. Select **Scan**.
5. Select one of the following **Scan to** options:
 - **Network Folder/FTP** saves your scanned file to a specified folder on a network.

- **Email** lets you send scanned files through a pre-configured email server.
- **Computer** lets you scan to a connected computer using Document Capture Pro (Windows) or Document Capture (Mac).
- **Memory Device** saves your scanned file on a USB device and lets you select the file format, quality, and other settings.
- **Cloud** sends your scanned files to a destination that you have registered with Epson Connect.
- **WSD** lets you manage network scanning in Windows 10, Windows 8.x, Windows 7, or Windows Vista (English only). To use this feature, you must first set up a WSD (Web Services for Devices) port on your Windows 7 or Windows Vista computer (the port is set up automatically on Windows 10 and Windows 8.x).

6. Follow the instructions in the links below to complete your scan.

[Scanning to Email](#)

[Scanning to a Connected Computer](#)

[Scanning to a Memory Device](#)

[Scanning to the Cloud](#)

[Setting Up a WSD Port \(Windows 7/Windows Vista\)](#)

[Control Panel Scanning Options](#)

Parent topic: [Starting a Scan](#)

Related tasks

[Using Presets](#)

[Using Epson Scan to Cloud](#)

Related topics

[Placing Originals on the Product](#)

Scanning to Email

You can scan an original and email the scanned file using your product's control panel. You need to have a preconfigured email server before you can scan to email. You can enter email addresses directly on the product's control panel or select them from the **Recipient** tab. Make sure the date and time are set correctly so the time stamps on your emails are accurate.

1. Place your original on the product for scanning.

Note: To scan a double-sided or multi-page document, place all of the pages in the ADF.

2. Press the  home button, if necessary.

3. Select **Scan**.
4. Select **Email**.
5. Do one of the following:
 - Select an email address from any of the displayed frequent contacts.
 - Select **Keyboard** to use the on-screen keyboard to enter the email address for the recipient(s) and select **OK**.
 - Select **Contacts** and choose an email address from the list.
 - Select **History** to choose an email address from your recent scan history.
6. Select **Scan Settings**.
7. Select **File Format** to choose the file format for your scan.
8. Scroll down to change the **Subject** and **File Name**, if necessary.
9. Select any additional scan settings as necessary.
10. Select **Presets** to save your scan settings.

Note: Presets can be locked by an administrator. If you cannot access or change this setting, contact your administrator for assistance.

11. Select  **Send**.

Your product scans your original and emails the scanned file.

Parent topic: [Starting a Scan Using the Product Control Panel](#)

Related tasks

[Configuring Email Server Settings](#)

[Registering Contacts for Email, Network, or FTP Scanning - Control Panel](#)

Related topics

[Placing Originals on the Product](#)

Scanning to a Connected Computer

You can scan an original and save it to a connected computer using your product's control panel. The computer must be on the same network as the product and must have the Document Capture Pro Server software installed. The product must also be configured for Document Capture Pro Server.

You can save the scanned file as a PDF file. You can also set up custom scan settings using Document Capture Pro (Windows) or Document Capture (Mac) and automatically scan using those settings on your product control panel.

1. Place your original on the product for scanning.

Note: To scan a multi-page document, place all of the pages in the ADF.

2. Press the  home button, if necessary.
3. Select **Scan**.
4. Select **Computer**.
5. Select **Select Computer** to choose a computer to scan to, and select it when it appears.

Note: The computer you want to scan to must be on the same network as the product or connected to the product with a USB cable.

The **Select Job** screen appears:

6. Select one of the scan job options.

Note: The default scan job is **Scan to PDF**. Any additional scan job options must be added in Document Capture Pro (Windows) or Document Capture (Mac).

7. Select  **Save**.

Document Capture Pro (Windows) or Document Capture (Mac) scans the original to the connected computer.

Parent topic: [Starting a Scan Using the Product Control Panel](#)

Scanning to a Memory Device

You can scan an original and save the scanned image to a external USB device connected to your product.

1. Insert an external USB device into the product's USB port.
2. Place your original on the product for scanning.

Note: To scan a double-sided or multi-page document, place all of the pages in the ADF.

3. Press the  home button, if necessary.
4. Select **Scan**.
5. Select **Memory Device**.
6. Select the settings as necessary.
7. Select **Presets** to save your scan settings.

Note: Presets can be locked by an administrator. If you cannot access or change this setting, contact your administrator for assistance.

8. Select  **Save**.

Your product scans your original and saves the scanned file to the connected memory device.

Parent topic: [Starting a Scan Using the Product Control Panel](#)

Related tasks

[Connecting a USB Device](#)

Related topics

[Placing Originals on the Product](#)

Scanning to the Cloud

You can use the control panel to send your scanned files to a destination that you have registered with Epson Connect.

Note: Make sure to set up your product using Epson Connect before using this feature.

1. Place your original on the product for scanning.

Note: To scan a double-sided or multi-page document, place all of the pages in the ADF.

2. Press the  home button, if necessary.
3. Select **Scan**.
4. Select **Cloud**.
5. Select the **+** icon and select a cloud destination.
6. Select the settings as necessary.

7. Select **Presets** to save your scan settings.

Note: Presets can be locked by an administrator. If you cannot access or change this setting, contact your administrator for assistance.

8. Select  **Upload**.

Your product scans your original and saves the scanned file to the selected destination.

Parent topic: [Starting a Scan Using the Product Control Panel](#)

Setting Up a WSD Port (Windows 7/Windows Vista)

You can scan to a networked Windows computer using WSD (Web Services for Devices). You must first set up a WSD port on your Windows 7 or Windows Vista system (the port is set up automatically on Windows 11, Windows 10 and Windows 8.x).

Before you set up a WSD port, make sure you installed your product software, and connected your product and computer to the same network.

1. Turn on your product.
2. Print a network status sheet so you can identify the network name and model name for your product on the network.
3. Click  or **Start** and select **Computer**.
4. On the left side of the window, select **Network**.
5. Locate your product on the Network screen, right-click it, and select **Install**.
6. When you see the User Account Control screen, click **Continue**.

Note: If you see an Uninstall screen, click **Uninstall** and repeat these steps as necessary.

7. When you see the message **Your device is ready to use** in the Windows taskbar, click the message.
8. On the Driver Software Installation screen, make sure your product is listed as **Ready to use**. Then click **Close**.
9. Do one of the following:
 - **Windows 7:** Click  and select **Devices and Printers**.
 - **Windows Vista:** Click **Start** and select **Control Panel > Hardware and Sound > Printers**.

10. Make sure that an icon appears for your product's name on the network.

When you use WSD, select your product name to scan over the network.

Parent topic: [Starting a Scan Using the Product Control Panel](#)

Control Panel Scanning Options

Select the options you want to use for scanning.

Note: Not all options or settings may be available, depending on the **Scan to** option selected.

Scan Settings	Available options	Description
Color Mode	B&W	Select to scan images in black and white
	Color	Select to scan images in color
File Format	JPEG	Select for photos. You can also select the Compression Ratio .
	PDF (Single Page)	Select for documents. You can also select the Compression Ratio and PDF Settings .
	PDF (Multi Page)	
	PDF/A (Single Page)	
	PDF/A (Multi Page)	Select for scanned files that you can print from a device. Multi Page TIFF documents are scanned in black and white.
	TIFF (Single Page)	
TIFF (Multi Page)		
Resolution	200dpi	Select for documents
	300dpi	Select for photos
	600dpi	Select for highest quality printing
2-Sided	1-Sided	Lets you scan 2-sided originals placed in the ADF. If you select 2-Sided , you can also select the Orientation (Original) and the Binding (Original) .
	2-Sided	
Scan Area	Auto Cropping	Select to automatically adjust the scan area
	Various sizes	Select the page size for documents
	Max Area	Select for most photos

Scan Settings	Available options	Description
Original Type	Text	Specify the type of original you are scanning
	Text & Image	
	Photo	
Orientation (Original)	Readable Direction	Select the orientation direction for how you placed the originals
	Left Direction	
Density	Varying levels	Adjust the lightness or darkness of scanned images.
Remove Shadow	Off	Erase the shadows that appear in the center of a document when copying a book or the shadows that appear around a document when copying thick paper
	On	
Remove Punch Holes	Off	Erase the binding holes on a document
	On	
Subject	—	Enter a subject for your email
Attached File Max Size	Various sizes	Select the maximum file size that can be attached to an email
File Name	—	Enter a prefix, the date, and the time to the file name for your scanned file

Parent topic: [Starting a Scan Using the Product Control Panel](#)

Setting Up and Scanning to a Network Folder or FTP Server

Before you can scan to a network folder on your computer or on an FTP server, you need to create a shared folder and optionally register its location to your product's Contacts list. Select the links below as necessary to create and register the folder, and to scan to it over the network.

[Creating a Shared Network Folder](#)

[Registering Contacts for Network Folder or FTP Scanning - Web Config](#)

[Registering Contacts for Email, Network, or FTP Scanning - Control Panel](#)

[Scanning to a Network Folder or FTP Server](#)

Parent topic: [Starting a Scan](#)

Creating a Shared Network Folder

You can create a shared network folder on your computer or an FTP site and register its location to your product's Contacts list.

Note: If you are creating a shared network folder on a Mac, see your Mac documentation for instructions on creating the folder. The instructions here are for Windows.

First make sure you connected your product and computer to the same network.

Note: If you are running a Home version of the Windows operating system, you cannot create a shared folder on your Windows desktop or in the Documents or Pictures folder unless you have created a Home Group Configuration for sharing. You can, however, create a shared folder in the root of the C: drive on your system.

If you want to scan to a folder on an FTP server, contact the FTP server administrator for the server address and authentication access to a shared folder on the server.

1. If you are scanning to a network folder on your computer, do one of the following to check the format of your computer name:
 - **Windows 11, Windows 10, or Windows 8.x:** Hold down the Windows key on your keyboard and press the **X** key. Select **System** from the list that appears. Check the Computer Name or Device Name listed for your computer on the System window.
 - **Windows 7:** Click , right-click **Computer**, and select **Properties**. Check the Computer Name listed for your computer on the System window.

Note: The settings in these steps may vary, depending on your version of Windows. See Windows Help for details on your operating system.

2. If the computer's name uses any characters that are not alphanumeric (letters or numbers), do one of the following to change the computer's name:
 - **Windows 11, Windows 10, or Windows 8.x:** Select **Rename this PC** and follow the on-screen prompts.
 - **Windows 7:** Select **Change Settings**, change the computer's name, and click **OK**. (See Windows Help for instructions, if necessary.)

Note: You need to be logged into Windows as an administrator to change the computer's name. After changing the name, restart your computer.

3. Start File Explorer or Windows Explorer.
4. Create a folder on the Windows desktop with a folder name of 12 characters or less; otherwise, your product may not be able to access the folder.

Note: You need to be logged into Windows as an administrator to access the desktop folder and the document folder under each User folder.

5. Right-click the folder you created and select **Properties**.
6. On the **General** tab, deselect the **Read-only** checkbox to allow users to access the folder over the network.
7. Select the **Sharing** tab and click the **Advanced Sharing** button.

Note: You need to be logged into Windows as an administrator to select the **Advanced Sharing** button.

8. On the Advanced Sharing screen, select the **Share this folder** checkbox.
9. Click the **Permissions** button and select the following on the Share Permissions tab:
 - Select **Everyone** under Group or user names.
 - Select the checkbox in the **Allow** column for the **Change** setting.
10. Click **OK** to save the settings, then click **OK** again to close the Advanced Sharing window.
11. Select the **Security** tab and check that the Group or user names list at the top includes the current computer user and the administrators who can now access the folder.
12. Select the **Sharing** tab again and write down the **Network Path** listed under Network File and Folder Sharing at the top. This is the path you will register to your product's Contacts list so you can select it for network scanning.
13. Click **OK** or **Close**.

Now you can register the folder path to your product's Contacts list.

Parent topic: [Setting Up and Scanning to a Network Folder or FTP Server](#)

Registering Contacts for Network Folder or FTP Scanning - Web Config

You can register a list of contacts for scanning to a network folder or FTP server using Web Config and your computer's internet browser.

Before you begin, print a network status sheet and locate the IP address for your product on the sheet.

1. Start an internet browser on a computer that is using the same network as your product.

2. Type your product's IP address into the address bar and press **Enter**.
3. Click **Continue to this website (not recommended)**.
4. Click the **Scan/Copy** tab.
5. Click **Contacts**.
6. Select an empty number you want to use for the contact you are adding and click **Edit**.
7. Enter the following information for the contact:
 - **Name**: The name to display in your product's contact list.
 - **Index Word**: Enter a word to identify this entry when searching for it (up to 30 characters). This field is optional.
 - **Type**: Select **Network Folder (SMB)** or **FTP**.
 - **Assign to Frequent Use**: If you want to identify the contact as a frequently used address, select **On**. This makes it quicker to select the contact when you scan.
 - **Save to**: The network path to the shared folder.
Enter the folder path name in one of the following formats depending on the **Type** setting you selected:
 - **SMB**: host_name\folder
 - **FTP**: host_name/folder_name
 - **Secure Connection**: For FTP locations, select the secure connection type.
 - **User Name** and **Password**: Enter only if you have set up a password on your computer.
 - **Connection Mode**: For FTP locations, select **Passive Mode** if there is a firewall between the product and FTP server.
 - **Port Number**: For FTP locations, enter the port number.
 - **Certificate Validation**: For FTP locations, choose to enable or disable an imported certificate.
8. Click **Apply**.
After a moment, you see a message telling you that contact registration is complete.
9. Close your web browser.

Parent topic: [Setting Up and Scanning to a Network Folder or FTP Server](#)

Registering Contacts for Email, Network, or FTP Scanning - Control Panel

You can create a list of contacts for scanning to email or to a network folder or FTP.

Note: Contacts can be locked by an administrator. If you cannot access or change contacts, contact your administrator for assistance. You can create up to 200 contacts and contact groups combined (including fax contacts).

1. Press the  home button, if necessary.
2. Select **Settings > Contacts Manager > Register/Delete**.
3. Select **Add Entry**.
4. Select **Add Contact**.
5. Do one of the following:
 - To create a contact for scanning to fax, select **Fax**.
 - To create a contact for scanning to email, select **Email**.
 - To create a location for scanning to a network folder or FTP, select **Network Folder/FTP**.
6. Select the number you want to use for the contact you are adding.
7. Select the **Name** field. Use the on-screen keyboard to enter the contact name (up to 30 characters) and select **OK**.
8. Select the **Index Word** field. Use the on-screen keyboard to enter a word to use when searching for an entry (up to 30 characters) and select **OK**. (This field is optional.)
9. Do one of the following:
 - For a fax contact, select the **Enter Fax Number** field. Use the displayed keyboard to enter the fax number and select **OK**.
Select any other fax settings as necessary.
 - For an email contact, select the **Email Address (Required)** field. Use the on-screen keyboard to enter the address and select **OK**.
 - For a network folder or FTP location, select the **Communication Mode** field and select an option. Then select the **Location (Required)** field, use the on-screen keyboard to enter the location, and select **OK**. Enter other information if necessary.
Enter the folder path name for the location setting in one of the following formats depending on the **Communication Mode** setting you selected:
 - **SMB:** \\host name\folder
 - **FTP:** ftp://host name/folder name
10. Select **OK**.

Note: If you need to edit or delete scanning contacts, the procedures are the same as for fax contacts.

Parent topic: [Setting Up and Scanning to a Network Folder or FTP Server](#)

Scanning to a Network Folder or FTP Server

You can scan an image and save it to a network folder using your product's control panel. You can either enter the folder path directly on the product's control panel or select a folder from the **Destination** tab.

Note: Make sure the date and time are set correctly before using this feature.

1. Place your original on the product for scanning.

Note: To scan a double-sided or multi-page document, place your originals in the ADF.

2. Press the  home button, if necessary.
3. Select **Scan**.
4. Select **Network Folder/FTP**.

You see a screen like this:

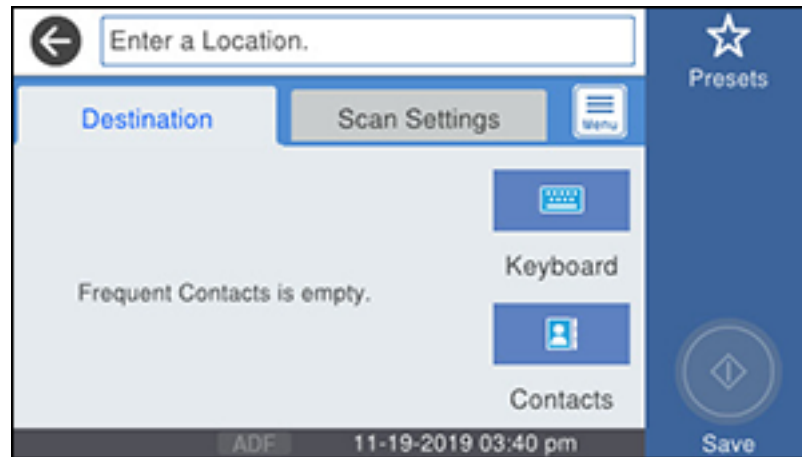

5. Do one of the following:
 - Choose a saved location on the **Destination** tab.

- Select **Keyboard**, select the **Communication Mode** field, and select **Network Folder (SMB)** or **FTP**. Then select the **Location (Required)** field, enter the folder location, and select **OK**. Enter other information as necessary.

Enter the folder path name for the location setting in one of the following formats depending on the **Communication Mode** setting you selected:

- **SMB:** \\host name\folder
- **FTP:** ftp://host name/folder name
- Select an email address from any displayed frequent contacts.

6. Select **Scan Settings**.
7. Select **File Format** to choose the file format for your scan.
8. Scroll down to select **File Name** and change it if necessary.
9. Select any additional scan settings as necessary.
10. Select **Presets** to save your scan settings.

Note: Presets can be locked by an administrator. If you cannot access or change this setting, contact your administrator for assistance.

11. Select  **Save**.

Your product scans your original and saves it in the selected location.

Parent topic: [Setting Up and Scanning to a Network Folder or FTP Server](#)

Related tasks

[Selecting the Date and Time](#)

Related topics



[Placing Originals on the Product](#)

Starting a Scan Using the Epson Scan 2 Icon

You can start the Epson Scan 2 program to select scan settings, scan, and save the scanned image to a file.

Note: If you are using your Epson product with the Windows 10 S operating system, you cannot use the software described in this section. You also cannot download and install any Epson product software

from the Epson website for use with Windows 10 S; you must obtain software only from the Windows Store.

- **Windows 11:** Click , then search for **Epson Scan 2** and select it.
- **Windows 10:** Click  and select **EPSON > Epson Scan 2**.
- **Windows 8.x:** Navigate to the **Apps** screen and select **Epson Scan 2**.
- **Windows (other versions):** Click  or **Start**, and select **All Programs** or **Programs**. Select **EPSON > Epson Scan 2 > Epson Scan 2**.
- **Mac:** Open the **Applications** folder, open the **Epson Software** folder, and select **Epson Scan 2**.

You see an Epson Scan 2 window like this:

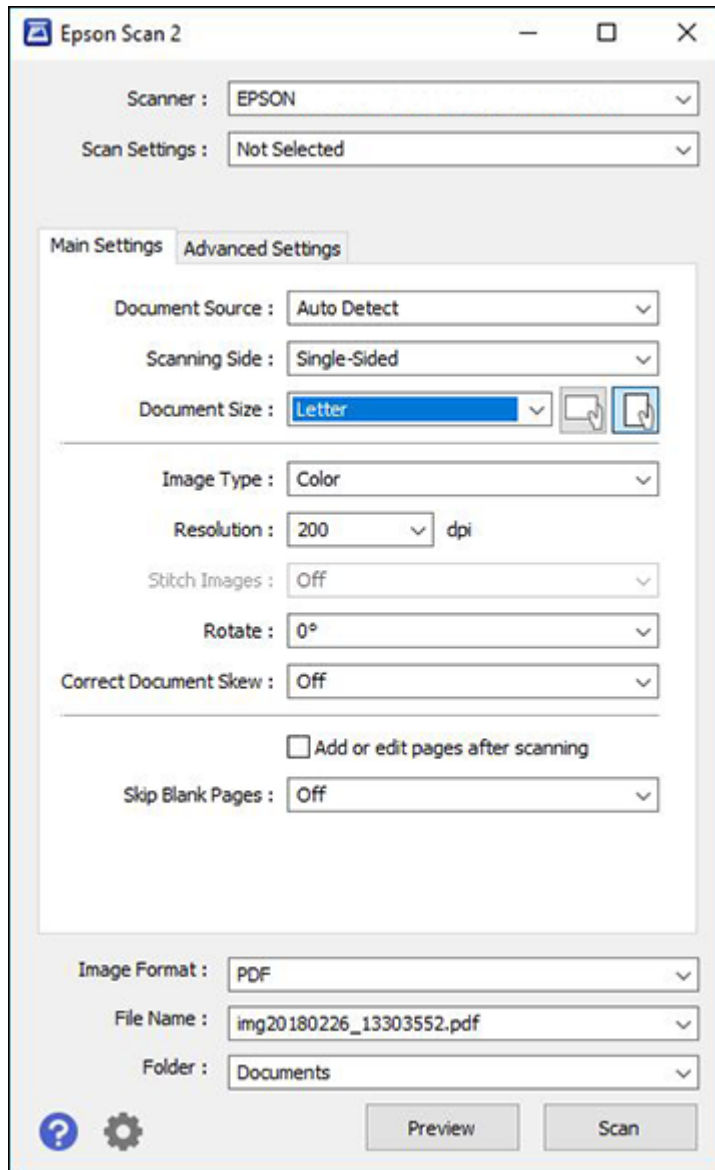

Parent topic: [Starting a Scan](#)

Related tasks

[Starting a Scan from a Scanning Program](#)

[Entering a User ID and Password for Scanning](#)

Related topics

[Placing Originals on the Product](#)

Starting a Scan from a Scanning Program

You can start Epson Scan 2 from a TWAIN-compliant scanning program to select scan settings, scan, and open the scanned image in the program.

Note: If you are using your Epson product with the Windows 10 S operating system, you cannot use the software described in this section. You also cannot download and install any Epson product software from the Epson website for use with Windows 10 S; you must obtain software only from the Windows Store.

1. Open your scanning program and select its scanning option. (See your scanning program help for instructions.)
2. Select your product.

Note: In certain programs, you may need to select your product as the "source" first. If you see a **Select Source** option, choose it and select your product. With Windows, do not select a **WIA** option for your product; not all scan functions will be available.

You see an Epson Scan 2 window like this:

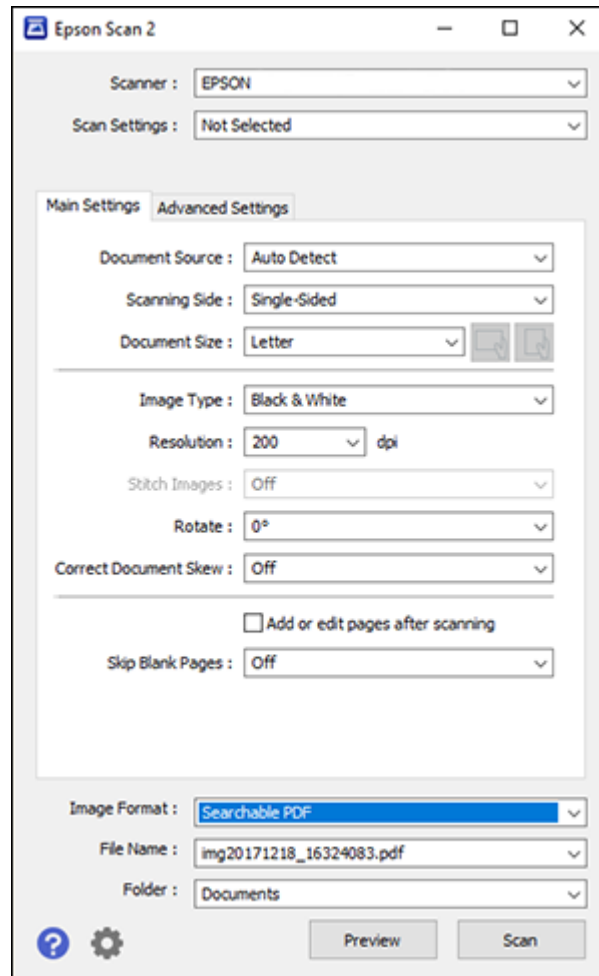

Parent topic: [Starting a Scan](#)

Related tasks

[Entering a User ID and Password for Scanning](#)

Related topics

[Placing Originals on the Product](#)

Starting a Scan from a Smartphone or Tablet

You can use the Epson Smart Panel app to scan from a network scanner to an iOS or Android device over a direct Wi-Fi connection.

1. Download the Epson Smart Panel app from your device's app store or from Epson's website. See the link below.
2. Place your original on the product for scanning.
3. Open the Epson Smart Panel app and select a scan menu on the home screen.
4. Follow the on-screen instructions to scan and save your original.

Parent topic: [Starting a Scan](#)

Related tasks

[Using the Epson Smart Panel Mobile App](#)

Related topics

[Placing Originals on the Product](#)

Scanning in Epson Scan 2

Epson Scan 2 gives you access to basic and advanced scanning features. You can scan your document and save the scanned image in various file formats in your operating system's Documents or My Documents folder, or open it in your scanning program. You can preview the scanned image and select or change settings as necessary.

Note: If you are using your Epson product with the Windows 10 S operating system, you cannot use the software described in this section. You also cannot download and install any Epson product software from the Epson website for use with Windows 10 S; you must obtain software only from the Windows Store.

1. Start Epson Scan 2.

You see this window:

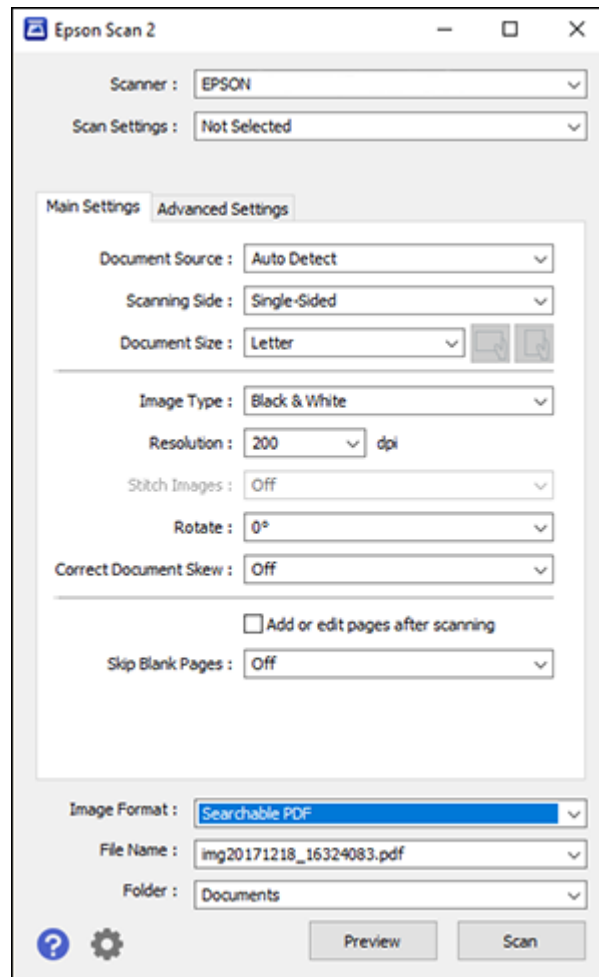

2. Select the **Document Source** setting that matches where you placed your original, or select **Auto Detect** to have Epson Scan 2 automatically detect the source.
3. Select the **Scanning Side** setting if you are scanning from the ADF.
4. Select the **Document Size** setting that matches the size of your original. You can select **Customize** to enter a custom size, if necessary.

5. Select the image type of your original and how you want it scanned as the **Image Type** setting.
6. Select the **Resolution** setting you want to use for your scan.
7. Select the **Rotate** setting to rotate the scanned image.
8. Select the **Correct Document Skew** setting to correct skewed originals, image contents, or both.
9. Click the **Preview** button.

Epson Scan 2 previews your original and displays the results in the Epson Scan 2 window.

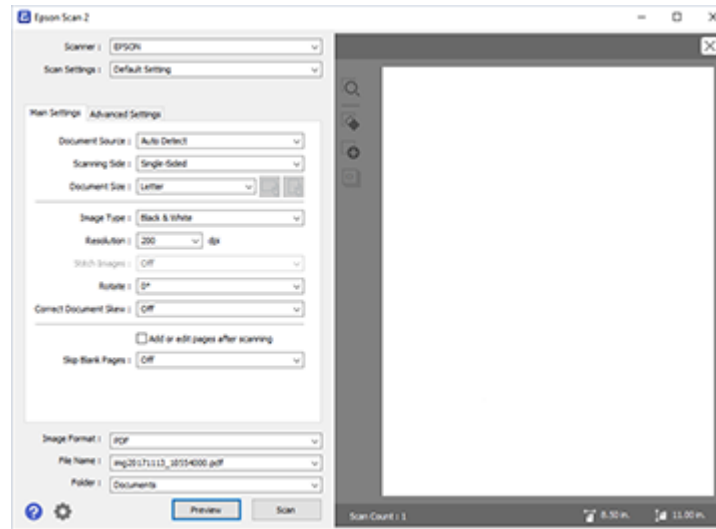

10. Reinsert your original into the ADF, if necessary.
11. Select any of the additional settings that you want to use on the Main Settings tab.
12. Click the **Advanced Settings** tab and select any settings that you want to use.
13. Select the format in which you want to save your scanned file as the **Image Format** setting. If necessary, select **Options** and select any desired format options.
14. Enter the file name for your scanned file in the **File Name** field. If necessary, select **Settings** to modify the file name settings.
15. Select the location in which you want to save your scanned file as the **Folder** setting. If necessary, select **Select** to create a new folder.
16. Click **Scan**.

The product scans your original and saves the scanned file in the location you specified.

[Additional Scanning Settings - Main Settings Tab](#)

[Additional Scanning Settings - Advanced Settings Tab](#)

[Saving Scanned Documents as a Searchable PDF Using Epson Scan 2](#)

[Image Format Options](#)

[Scan Resolution Guidelines](#)

Parent topic: [Scanning](#)

Related topics

[Placing Originals on the Product](#)

Additional Scanning Settings - Main Settings Tab

You can select these additional scanning settings on the Epson Scan 2 Main Settings tab. Not all adjustment settings may be available, depending on other settings you have chosen.

Stitch Images

When scanning double-sided originals, lets you lay out images from both sides of the original onto one scanned page.

Rotate

Rotates the original image clockwise to the desired angle before scanning it. Select **Auto** to allow your product to automatically rotate the image based on the orientation of the text (may take longer to scan).

Correct Document Skew

Corrects skewed originals, image contents, or both.

Add or edit pages after scanning

Lets you add, remove, or edit the pages in a scan, including rotating pages and changing the page order.

Note: To save multiple pages in a single file, you must select a file format that supports multiple pages such as **PDF** or **Multi-TIFF**. If you select another file format, each scanned image or page is saved as a separate file.

Skip Blank Pages

If the scanner detects marks from the other side of a blank page and adds the marks to the scanned image, adjust this setting to prevent this.

Parent topic: [Scanning in Epson Scan 2](#)

Additional Scanning Settings - Advanced Settings Tab

You can select these additional scanning settings on the Epson Scan 2 Advanced Settings tab. Not all adjustment settings may be available, depending on other settings you have chosen.

Remove Background

Removes the background of the originals.

Text Enhancement

Sharpens the appearance of letters in text documents.

Auto Area Segmentation

Makes black and white images clearer and text recognition more accurate by separating the text from the graphics.

Threshold

Adjusts the level at which black areas in text and line art are delineated, improving text recognition in OCR (Optical Character Recognition) programs.

Color Enhance

Enhances the shades of the color you select in the scanned image. This setting is available only if you select **Grayscale** or **Black & White** as the Image Type setting.

Brightness

Adjusts the overall lightness and darkness of the scanned image.

Contrast

Adjusts the difference between the light and dark areas of the overall scanned image.

Gamma

Adjusts the midtone density of the scanned image.

Sharpness

Makes the edges of certain image areas clearer. Turn off this option to leave softer edges.

Descreening

Removes the ripple pattern that might appear in subtly shaded image areas, such as skin tones. This option improves results when scanning magazines or newspapers. (The results of descreening do not appear in the preview image, only in your scanned image.)

Edge Fill

Corrects shadowing around the edges of the image by filling the shadows with black or white.

Dual Image Output

Scans the original image twice using different output settings (Windows only).

Watermark

Adds a watermark to a scanned image.

Parent topic: [Scanning in Epson Scan 2](#)

Saving Scanned Documents as a Searchable PDF Using Epson Scan 2

You can scan a document and save the text in a searchable PDF. In a searchable PDF, text is recognized using Optical Character Recognition (OCR) and then embedded in the scanned original.

Note: The required Epson Scan 2 OCR Component is installed automatically when you install your product software as instructed on the *Start Here* sheet. If you install your scanner software programs individually, be sure to also install this component if you want to perform OCR.

1. Load your original in the product for scanning.
2. Start Epson Scan 2.
3. Select your scan settings.
4. Click **Preview** and adjust the area you want to scan, if necessary.
5. If you are using the ADF, reload the ejected original.
6. Select **Searchable PDF** as the Image Format setting.
7. Select **Options** from the Image Format list.

You see this window:

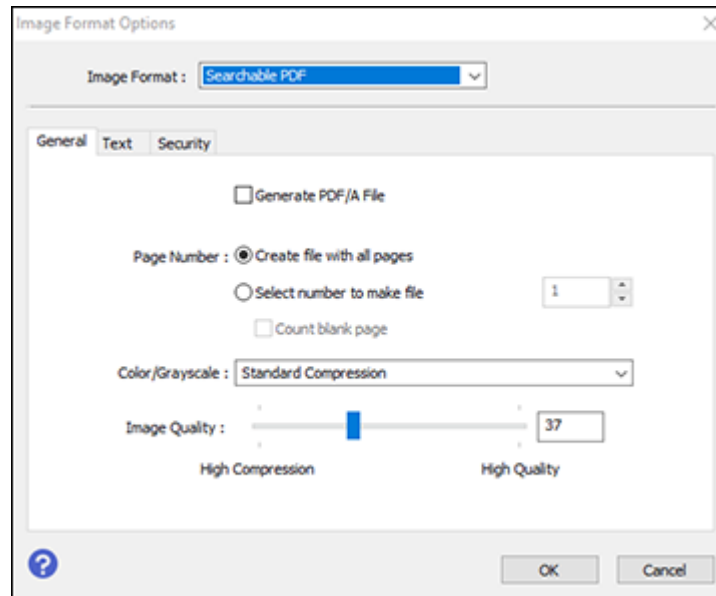

8. Select any of the options on the General tab.
9. Select the **Text** tab.
10. Make sure the language used in the document text is selected as the **Text Language** setting.
11. Select the **Security** tab if you want to add a password to the PDF or protect printing or editing properties.
12. Click **OK**.
13. Confirm the **File Name** setting and select a **Folder** setting for your document.
14. Click **Scan**.

The scanned image is saved as a searchable PDF.

Parent topic: [Scanning in Epson Scan 2](#)

Related topics

[Placing Originals on the Product](#)

Image Format Options

You can select different image formats and related options. For details on available options, click the ? icon on the Epson Scan 2 Image Format Options window. Not all image formats have options.

BITMAP (*.bmp)

A standard image file format for most Windows programs.

JPEG (*.jpg)

An image format that lets you highly compress image data. However, the higher the compression, the lower the image quality. (The TIFF format is recommended when you need to modify or retouch your scanned image.)

PNG (*.png)

An image format that does not lose quality during editing.

TIFF (*.tif)

A file format created for exchanging data between many programs, such as graphic and DTP software.

Multi-TIFF (*.tif)

A TIFF file format when multiple pages are saved to the same file, allowing you to edit the images using a compatible program.

PDF (*.pdf)

A document format that is readable by Windows and Mac systems using Adobe Reader, Acrobat, or other programs. You can save multi-page documents in one PDF file.

Searchable PDF (*.pdf)

A document format that is readable by Windows and Mac systems using Adobe Reader, Acrobat, or other programs. You can save multi-page documents in one PDF file. Recognized text in the scanned document can be searched.

Parent topic: [Scanning in Epson Scan 2](#)

Scan Resolution Guidelines

The **Resolution** setting, measured in dpi (dots per inch), controls the amount of detail captured in your scans. Increasing the resolution raises the amount of detail captured but comes with the following disadvantages:

- Larger file sizes
- It takes longer to scan your originals, send/receive your scans by email or fax, and to print your scans
- The image may become too large to fit on your display or print on paper

If you plan to enlarge a scanned image so you can print it at a larger size, you may need to increase the resolution from the default resolution set by Epson Scan 2. Follow these guidelines to determine the resolution setting you need:

- You will scan the image at its original size but enlarge it later in an image-editing program.
Increase the Epson Scan 2 Resolution setting in your scan. Increase the resolution by the same amount you will increase the image size to retain a high image quality. For example, if the resolution is 300 dpi (dots per inch) and you will double the image size later, change the Resolution setting to 600 dpi.
- You will scan the image at 100% or a smaller size.
Select the Epson Scan 2 Resolution setting based on how you will use the scanned image:
 - Email/view on a computer screen/post on the web: 96 to 200 dpi
 - Print/fax/convert to editable text (OCR)/create searchable PDF: 200 to 300 dpi

Parent topic: [Scanning in Epson Scan 2](#)

Scanning with Document Capture Pro or Document Capture

When you scan with Document Capture Pro (Windows) or Document Capture (Mac), the program automatically saves your scanned file on your computer in the folder you specify. You can preview and edit the scanned file, change the scanned file settings, and send to a destination if necessary.

[Scanning with Simple Scan in Document Capture Pro - Windows](#)

[Scanning with Job Scan in Document Capture Pro - Windows](#)

[Scanning Two Originals onto One Sheet \(Stitching Images\) - Windows](#)

[Scanning Multi-Page Originals as Separate Files - Windows](#)

[Scanning with Document Capture - Mac](#)

Parent topic: [Scanning](#)



Related topics

[Placing Originals on the Product](#)

Scanning with Simple Scan in Document Capture Pro - Windows

You can use the Simple Scan option in Document Capture Pro to quickly scan an original.

Note: Settings may vary depending on the software version you are using. Click the **Help** icon in Document Capture Pro at any time for more information.

1. Load your original in the product.
2. Do one of the following to start Document Capture Pro:
 - **Windows 11:** Click , then search for **Document Capture Pro** and select it.
 - **Windows 10:** Click  and select **Epson Software > Document Capture Pro**.
 - **Windows 8.x:** Navigate to the **Apps** screen and select **Document Capture Pro**.
 - **Windows (other versions):** Click  or **Start**, and select **All Programs** or **Programs**. Select **Epson Software > Document Capture Pro**.

You see the Document Capture Pro window.

Note: You may need to select your scanner from the list, if necessary.

3. Select the **Simple Scan** tab.

You see a window like this:

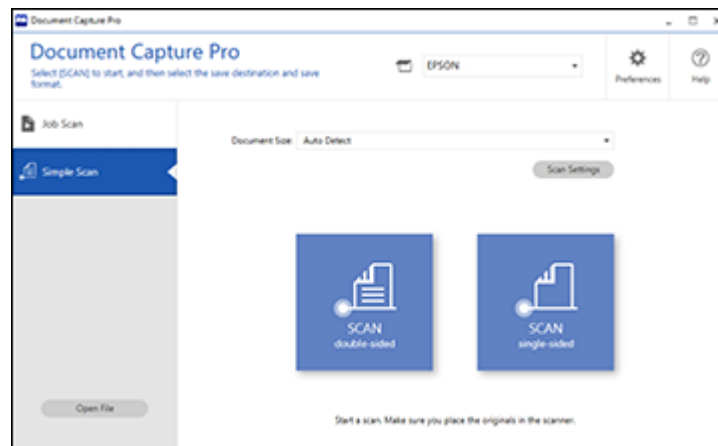

4. Select the size of your original from the **Document Size** menu.
5. If you want to change specific settings for the scan, click the **Scan Settings** button. Change any of the settings as necessary and click **OK**. For additional settings, click the **Detailed Settings** button on the Scan Settings screen.

6. Do one of the following:
 - To scan the front side of an original, select **SCAN single-sided**.
 - To scan both sides of an original, select **SCAN double-sided**.Your product scans the original and the image appears in the Edit Scanned Results window.
7. Review and edit the scanned image as necessary and click **Next** when you are finished.
8. Select a destination for the scanned image, change any settings as necessary, and click **Complete**.



Note: If you are sending the scanned image to a server or cloud destination, you need to enter your login information.

Parent topic: [Scanning with Document Capture Pro or Document Capture](#)

Scanning with Job Scan in Document Capture Pro - Windows

You can create scan jobs in Document Capture Pro and use them to quickly scan originals and save them to various destinations.

Note: Settings may vary depending on the software version you are using. Click the **Help** icon in Document Capture Pro at any time for more information.

1. Load your original in the product.
2. Do one of the following to start Document Capture Pro:
 - **Windows 11:** Click , then search for **Document Capture Pro** and select it.
 - **Windows 10:** Click  and select **Epson Software > Document Capture Pro**.
 - **Windows 8.x:** Navigate to the **Apps** screen and select **Document Capture Pro**.
 - **Windows (other versions):** Click  or **Start**, and select **All Programs** or **Programs**. Select **Epson Software > Document Capture Pro**.

You see the Document Capture Pro window.

Note: You may need to select your scanner from the list, if necessary.

3. Select the **Job Scan** tab.

You see a window like this:

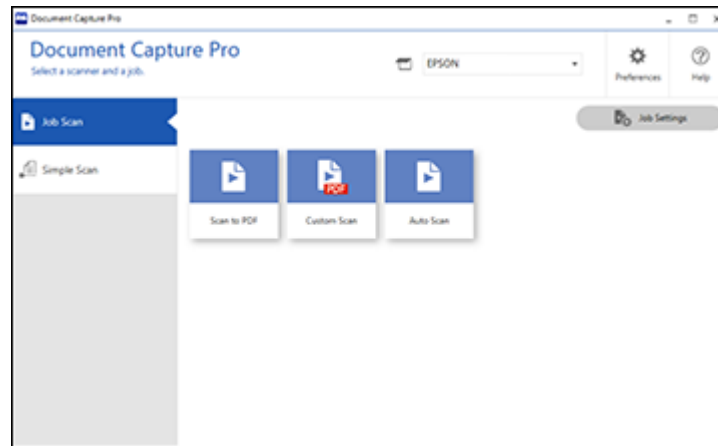

4. Select one of the scan jobs (or click **Job Settings** to create a new scan job).
The product scans the loaded original and saves it according to the job settings.
5. Depending on the settings for the scan job you selected, you may be able to view and edit the pages before saving them. If so, click **Complete** when finished.
The scanned image is saved according to the job settings.



[Adding and Assigning Scan Jobs with Document Capture Pro - Windows](#)

Parent topic: [Scanning with Document Capture Pro or Document Capture](#)

Adding and Assigning Scan Jobs with Document Capture Pro - Windows

You can add scan jobs that contain specific scan settings and use the jobs when you scan from your product control panel or the Job Scan option in Document Capture Pro. You can save up to 30 scan jobs.

Note: Settings may vary depending on the software version you are using. Click the **Help** icon in Document Capture Pro at any time for more information.

1. Do one of the following to start Document Capture Pro:
 - **Windows 11:** Click , then search for **Document Capture Pro** and select it.
 - **Windows 10:** Click  and select **Epson Software > Document Capture Pro**.

- **Windows 8.x:** Navigate to the **Apps** screen and select **Document Capture Pro**.
- **Windows (other versions):** Click  or **Start**, and select **All Programs** or **Programs**. Select **Epson Software > Document Capture Pro**.

You see the Document Capture Pro window.

2. Select the **Job Scan** tab.

You see a window like this:

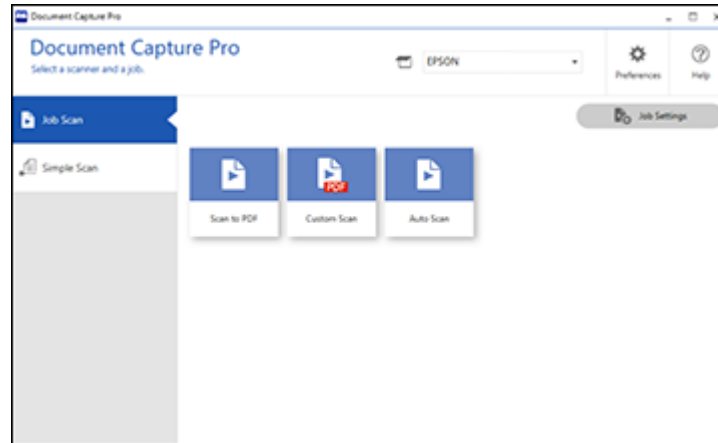

3. Click the **Job Settings** button.

You see a window like this:

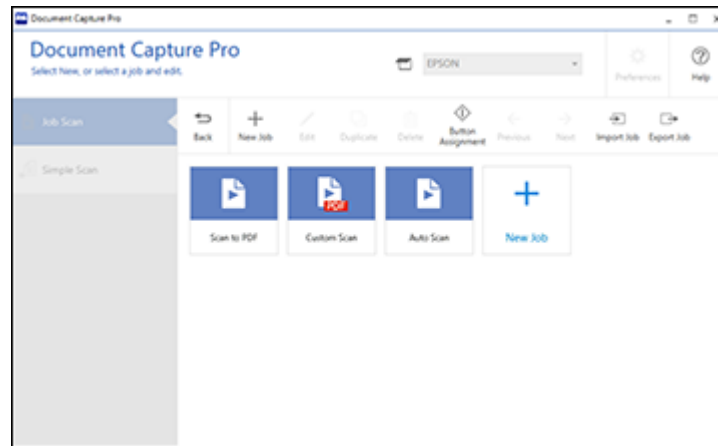

4. To add a scan job, click the **New Job** icon.
5. Enter a name for the new job, and select any settings as necessary from the following options:
 - **Scan**: select the size, color, or resolution
 - **Save**: select the file name, file type, or destination folder
 - **Index**: enable the index setting and choose output options for an index file
 - **Send**: select the destination for the scanned file, or choose to email or print the file
 - **Confirm/Test**: select the job button icon and color, choose display settings, and run a test scan if necessary
6. Click **Save** when you are finished.
The new job appears in the Job Scan window.
7. To assign a scan job to the product control panel, click the **Button Assignment** icon.

You see a screen like this:

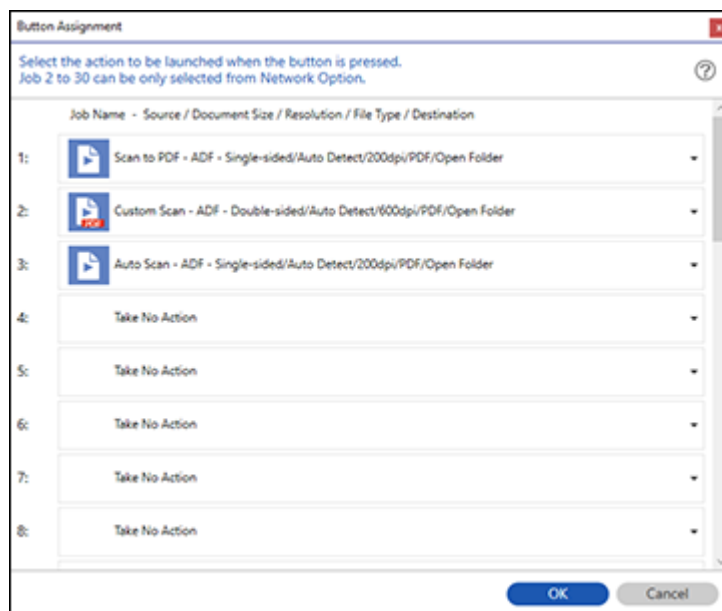

8. Select the jobs that you want to assign to the product control panel using any of the pull-down menus.

Note: The number of pull-down menus available may vary, depending on your product and any connected options.

9. Click **OK**, then click **Back**.

You can now use the added scan jobs when you scan from the product control panel.

Parent topic: [Scanning with Job Scan in Document Capture Pro - Windows](#)

Scanning Two Originals onto One Sheet (Stitching Images) - Windows



You can scan both sides of a double-sided or folded original in Document Capture Pro and combine them into a single image with the Epson Scan 2 Stitch Images setting (not available for all products).

Note: Settings may vary depending on the software version you are using. Click the **Help** icon in Document Capture Pro at any time for more information.

1. Load your original in the product.

Note: If an optional carrier sheet is included with your product, use it when scanning a folded original or damage to the original may occur. Place the original into the carrier sheet with the folded edge against the right side of the carrier sheet. Make sure to insert the carrier sheet into your product with the white edge facing down.

2. Do one of the following to start Document Capture Pro:

- **Windows 11:** Click , then search for **Document Capture Pro** and select it.
- **Windows 10:** Click  and select **Epson Software > Document Capture Pro**.
- **Windows 8.x:** Navigate to the **Apps** screen and select **Document Capture Pro**.
- **Windows (other versions):** Click  or **Start** and select **All Programs** or **Programs**. Select **Epson Software > Document Capture Pro**.

3. Select the **Simple Scan** tab.

You see a window like this:

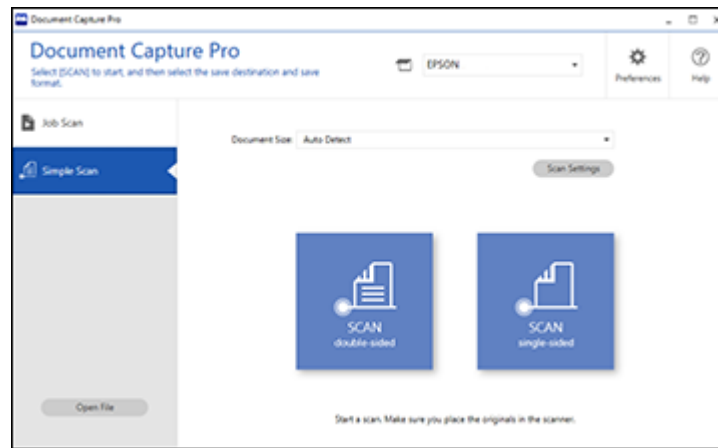

4. Click **Scan Settings > Detailed Settings**.

You see an Epson Scan 2 window like this:

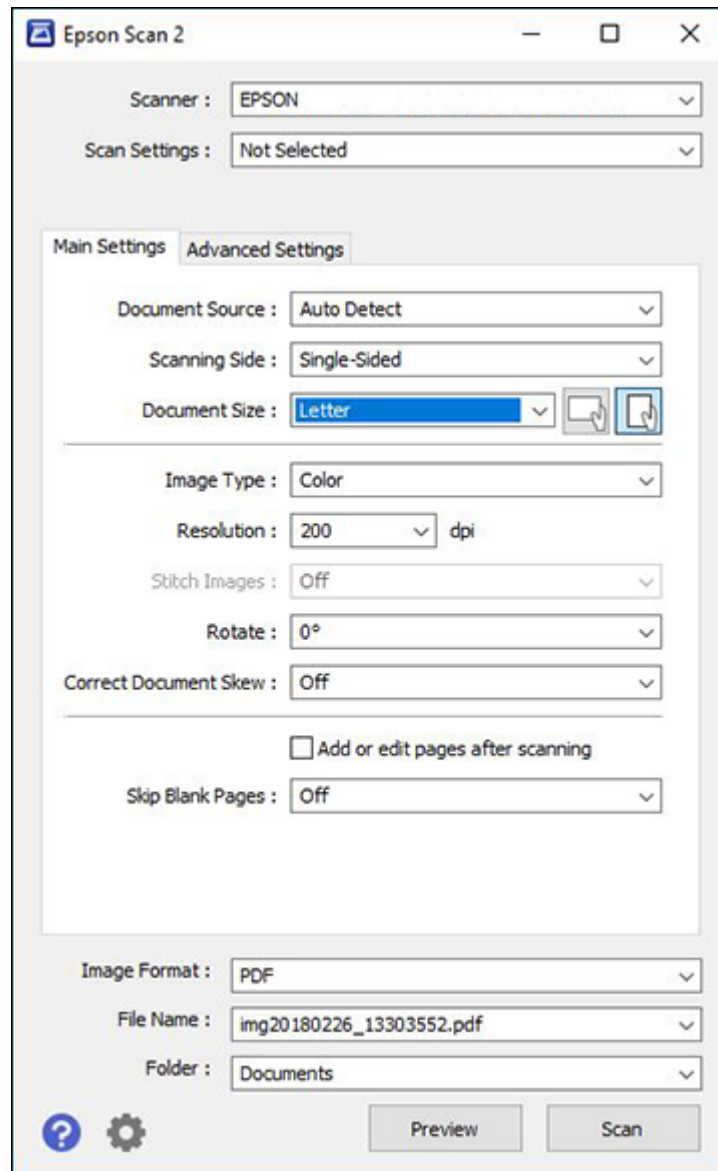

5. Select **Double-Sided** as the **Scanning Side** setting.
6. Select the original document size or **Auto Detect** as the **Document Size** setting.
7. Select one of the following as the **Stitch Images** setting:
 - **Top & Bottom**: Places the scanned images one above the other.
 - **Left & Right**: Places the scanned images side by side.
8. Select the **Advanced Settings** tab and verify that the **Edge Fill** setting is set to **None**.
9. Click **Save**.
10. Click **OK**.
11. Click **SCAN double-sided**.

Your product scans the original and the image appears in the Edit Scanned Results window.

Note: If the scanned images are not stitched together in the correct orientation, click **Scanning Side** on the Epson Scan 2 window, select **Settings**, set the Binding Edge to **Left** or **Top**, and rescan the document.

12. Review and edit the scanned pages as necessary and click **Next** when you are finished.
13. Select a destination and any settings as necessary and click **Complete**.

Parent topic: [Scanning with Document Capture Pro or Document Capture](#)

Related topics



[Placing Originals on the Product](#)

Scanning Multi-Page Originals as Separate Files - Windows

You can use Document Capture Pro to scan multi-page originals as separate scanned files. You can indicate how the separate files are created by defining a maximum page count per file or by inserting blank pages, barcodes, or characters that can be detected by the software as separation markers.

Note: Settings may vary depending on the software version you are using. Click the **Help** icon in Document Capture Pro at any time for more information.

1. Load your multi-page original in the product.
2. Do one of the following to start Document Capture Pro:
 - **Windows 11:** Click , then search for **Document Capture Pro** and select it.

- **Windows 10:** Click  and select **Epson Software > Document Capture Pro**.
- **Windows 8.x:** Navigate to the **Apps** screen and select **Document Capture Pro**.
- **Windows (other versions):** Click  or **Start**, and select **All Programs** or **Programs**. Select **Epson Software > Document Capture Pro**.

You see the Document Capture Pro window.

3. Select the **Job Scan** tab.

You see a window like this:

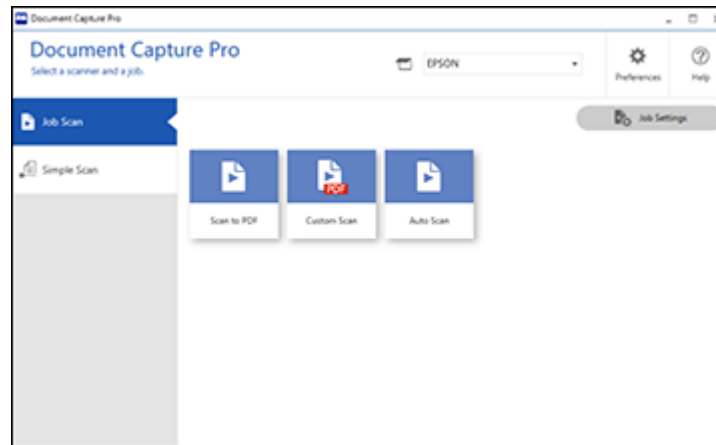

4. Click the **Job Settings** button.

You see a window like this:

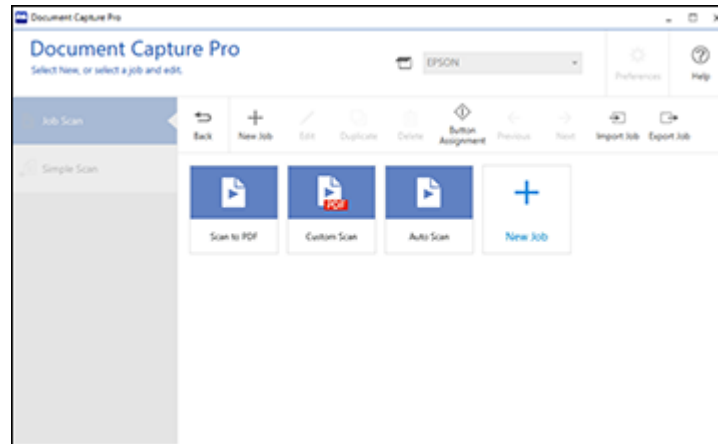

5. Select **New Job** and select the scan settings. Click **Next** when finished. You see a window like this:

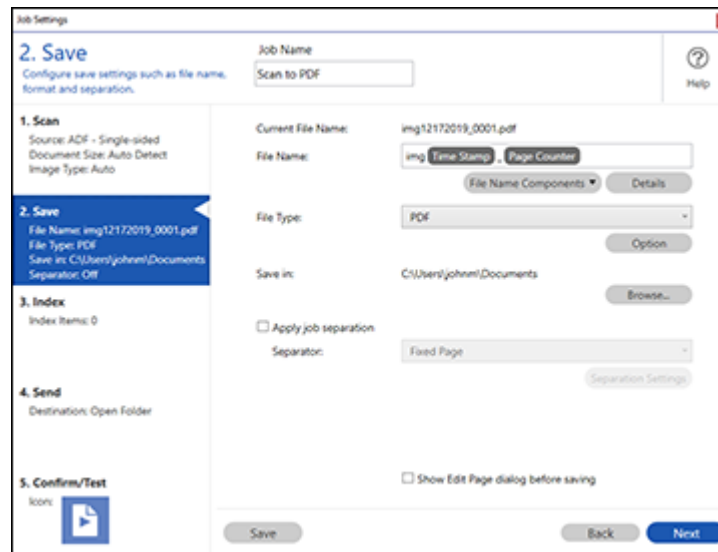

6. Select the **Apply job separation** checkbox.
7. Select the method you want to use to separate the originals as the **Separator** setting. Click **Separation Settings** to specify the settings for the selected option.

8. Finish creating the new scan job and click **Save**.
9. Click **Back** on the Job Settings screen.

Your originals are saved into separate files and folders as specified when the job is run.

Parent topic: [Scanning with Document Capture Pro or Document Capture](#)

Related topics

[Placing Originals on the Product](#)

Scanning with Document Capture - Mac

When you scan with Document Capture, the program automatically saves your scanned file on your computer in the folder you specify. You can select settings, preview, and change the scanned file settings as necessary.

Note: Settings may vary depending on the software version you are using. See the **Help** menu in Document Capture at any time for more information.

1. Load your original in the product.
2. Open the **Applications** folder, open the **Epson Software** folder, and select **Document Capture**.

You see a window like this:

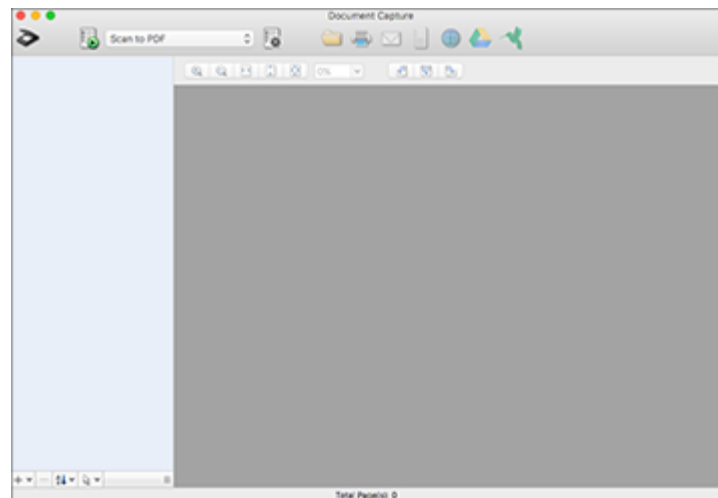

Note: You may need to select your scanner from the scanner list.

3. Click the  scan icon.

You see a window like this:

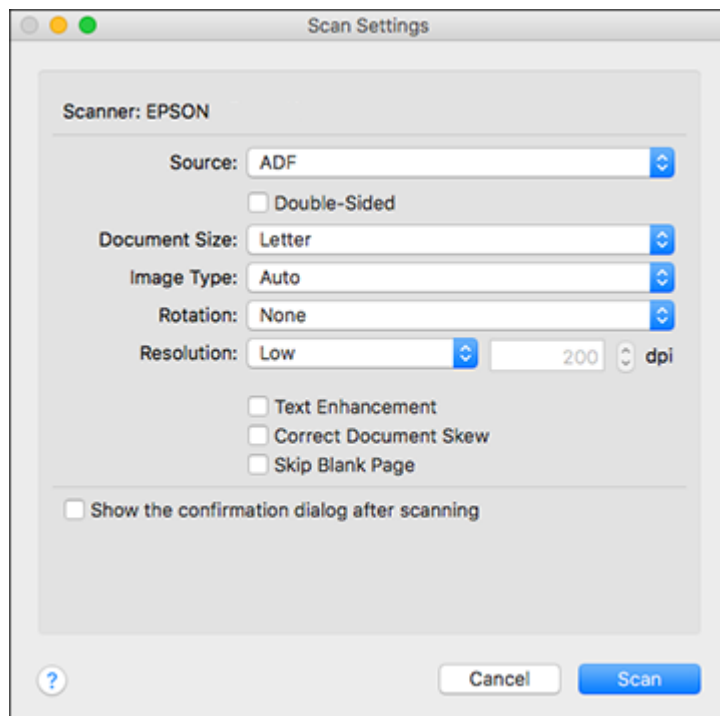

Note: If you want to use a scan job that you created instead, select it from the Job list in the Document Capture window, click the  Start Job button, and skip the rest of these steps.

4. Select any displayed scan settings you want to use.

Note: See the Help information in Document Capture for details.

5. If you want to select detailed scan settings, close the Scan Settings window, open the **Scan** menu at the top of the Mac desktop, and select **Displays the EPSON Scan Setup Screen**.

6. Click the  Scan icon and select any detailed scan settings you want to use from the Epson Scan 2 window.
7. Click **Scan**.

You see a preview of your scan in the Document Capture window.

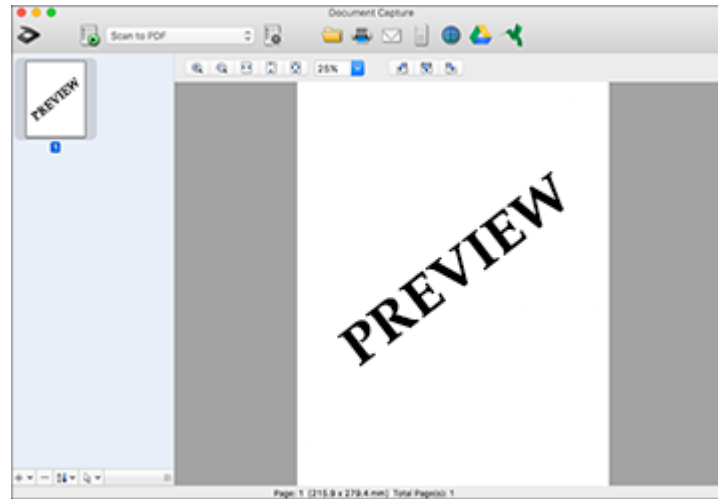

Note: You may have to close the Epson Scan 2 window to view your scan in the Document Capture window.

8. If you would like to scan additional originals and add them to the current captured images, click the + icon, select **Acquire from Scanner**, and repeat the previous steps.
9. Check the scanned images and edit them as necessary.
10. Click one of the destination icons to choose where to send your scanned files. (If you cannot see all of the icons below, click the arrow next to the icons.) Change any settings as necessary.



Note: If you are sending the scanned image to a server or cloud destination, you need to enter your login information.

11. Depending on the destination you chose, click **OK** or **Send** to complete the operation.

[Adding and Assigning Scan Jobs with Document Capture - Mac](#)

Parent topic: [Scanning with Document Capture Pro or Document Capture](#)



Related topics

[Placing Originals on the Product](#)

Adding and Assigning Scan Jobs with Document Capture - Mac

You can add scan jobs that contain specific scan settings and use the jobs when you scan from your product control panel or Document Capture. You can save up to 30 scan jobs.

Note: Settings may vary depending on the software version you are using. See the **Help** menu in Document Capture at any time for more information.

1. Start Document Capture on a computer connected to the product.
2. Click the  Manage Job icon from the toolbar at the top of the window.
You see a window showing the current scan job list.
3. To add a scan job, click the **+** icon, enter a name for the new job, select settings as necessary, and click **OK**.
You can now use the new scan job when you scan with Document Capture.
4. To assign a scan job to the product control panel, click the  settings icon at the bottom of the window and click **Event Settings**.
5. Select the jobs that you want to assign to the product control panel using any of the pull-down menus.

Note: The number of pull-down menus available may vary, depending on your product and any connected options.

6. Click **OK**, then click **OK** again.
You can now use the added scan jobs when you scan from the product control panel.

Parent topic: [Scanning with Document Capture - Mac](#)

Entering a User ID and Password for Scanning

If you enabled Access Control on your product, a user ID and password may be required to scan. You can enter the user ID and password in Epson Scan 2.

Note: If you do not know the user ID or password, contact your administrator for assistance.

1. Start Epson Scan 2.
2. Select **Settings** from the **Scanner** drop-down list.

You see this window:

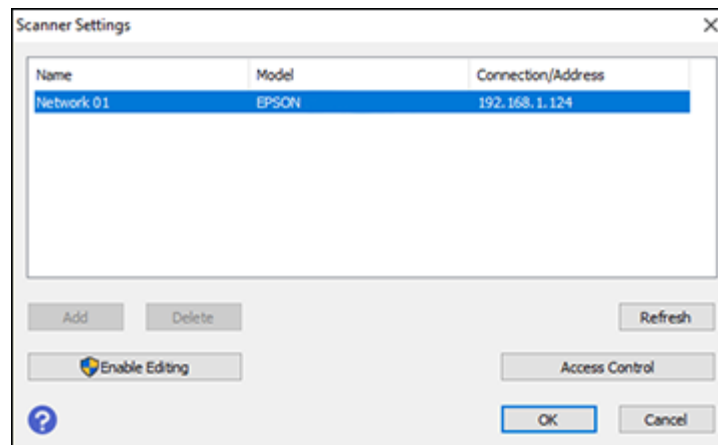

3. Select **Access Control**.
4. Enter your user name and password.
5. Click **OK**.

Parent topic: [Scanning](#)

Faxing

See these sections to fax using your product.

Note: This product allows you to store names, telephone numbers, and fax data in its memory even when the power is turned off. Make sure you restore all of the default settings if you give away or dispose of the product. This will erase all of your network settings and fax data.

Note: When using the PCL or PostScript (PS3) printer software with the product, you can fax using the printer buttons or the utilities included with the standard Epson printer software. To download the standard Epson printer software, visit epson.com/support (U.S.), epson.ca/support (Canada), or epson.com.jm/support (Caribbean) and select your product.

[Connecting a Telephone or Answering Machine](#)

[Setting Up Fax Features](#)

[Setting Up Contacts and Contact Groups](#)

[Sending Faxes](#)

[Receiving Faxes](#)

[Checking Fax Status](#)

[Viewing a Fax on the LCD Screen \(Using the Fax Box\)](#)

[Printing Fax Reports](#)

Connecting a Telephone or Answering Machine

You must connect your product to a telephone wall jack to send or receive faxes. If you want to use the same telephone line to receive calls, you can connect a telephone or answering machine to your product using an additional phone cable.

Note: You may not be able to use the printer with the following phone lines or systems:

- VoIP phone line such as DSL or fiber-optic digital service
- Digital phone line (ISDN)
- Some PBX telephone systems
- When adapters such as terminal adapters, VoIP adapters, splitters, or DSL router are connected between the telephone wall jack and the printer

1. Connect a phone cable to your telephone wall jack and to the **LINE** port on your product.

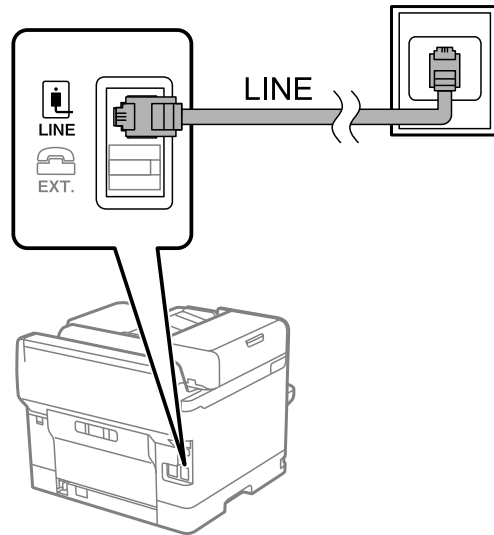

Note: If you have a DSL or ISDN connection, you must connect the appropriate DSL filter, or ISDN terminal adapter or router to the wall jack to be able to use the line for faxing or voice calls using your product. Contact your DSL or ISDN provider for the necessary equipment.

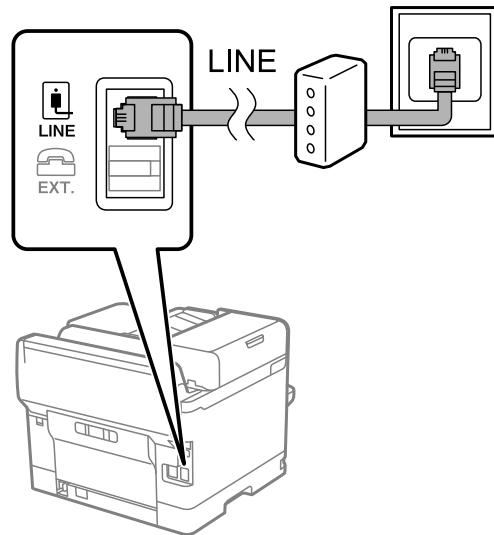

2. If you are connecting a telephone or answering machine to your product using a second phone cable, remove the cap from the **EXT** port on your product.

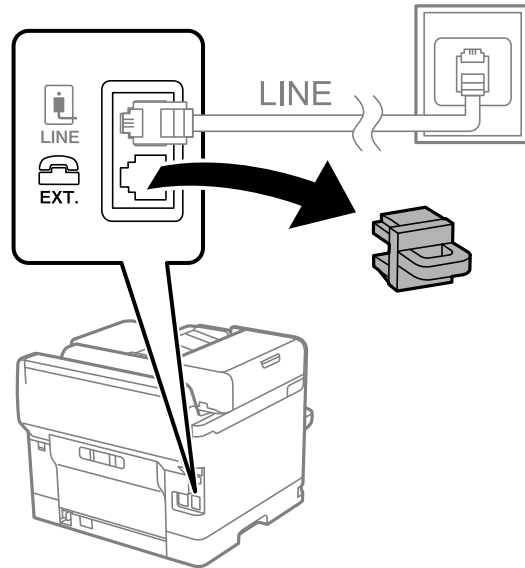

Note: If your telephone has a fax function, disable the fax function before connecting it. If you are not able to completely disable the fax function on your telephone, you may not be able to use it as an external telephone.

3. Connect a second phone cable to your telephone or answering machine and to the **EXT** port on your product.

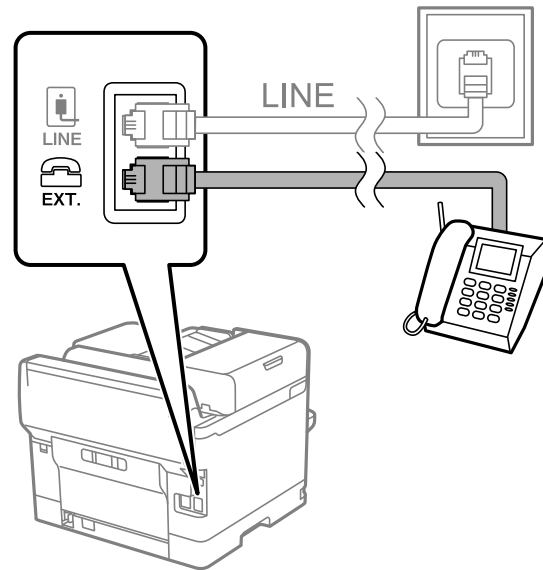

Note: If you connect an answering machine and Receive Mode is set to **Auto**, set the number of rings before your product answers a call to a number that is higher than your answering machine's setting for the number of rings.

Make sure to connect the telephone to the **EXT** port on your product. If you split the telephone line between your telephone and the product, they will not work correctly.

Parent topic: [Faxing](#)

Related references

[Cannot Receive Faxes with a Telephone Connected to Your Product](#)

Related tasks

[Receiving Faxes Automatically](#)

[Using the Fax Setup Wizard](#)

Setting Up Fax Features

Before faxing with your product, set up your fax header and select the fax features you want to use.

Note: If you leave your product unplugged for a long period of time, you may need to reset the date and time settings for faxes.

[Setting Up Basic Fax Features](#)

[Selecting Advanced Fax Settings](#)

[Setting Up the Fax Utility - Windows](#)

[Setting Up Fax Features Using the Fax Utility - Mac](#)

Parent topic: [Faxing](#)

Setting Up Basic Fax Features

See these sections to select the basic settings you need to use the product's fax features.

[Using the Fax Setup Wizard](#)

[Selecting the Line Type](#)

[Setting the Number of Rings to Answer](#)

Parent topic: [Setting Up Fax Features](#)

Using the Fax Setup Wizard

You can setup the product's basic fax settings using the Fax Setting Wizard. This wizard is automatically displayed when the product is turned on for the first time. You can also change these settings individually from the Fax Settings menu.

Note: These settings can be locked by an administrator. If you cannot access or change these setting, contact your administrator for assistance.

1. Press the  home button, if necessary.
2. Select **Settings > General Settings > Fax Settings > Fax Setting Wizard**.

You see a screen like this:

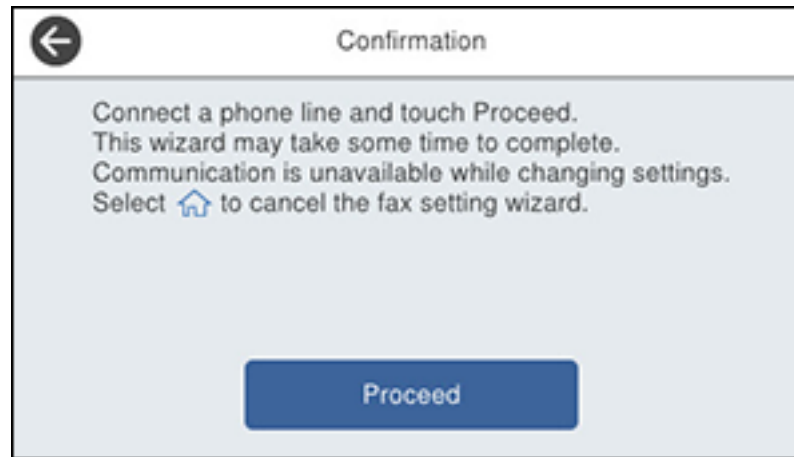

3. Select **Proceed**.
4. On the Fax Header screen, use the displayed keypad to enter the sender name for your fax source, such as your name or a business name. You can enter up to 40 characters. Select **OK** when you are done.
5. On the Your Phone Number screen, use the displayed keypad to enter your fax number, up to 20 characters. Select **OK** when you are done.

Note: The name and phone number in the fax header identifies the source of the faxes you send.

6. On the Distinctive Ring Setting screen, do one of the following:
 - If you have subscribed to a distinctive ring service from your telephone company, select **Proceed**. Select the ring pattern to be used for incoming faxes or select **All**. Go to the next step.
 - If you do not have a distinctive ring service, select **Skip** and go to step 9.

Note: Distinctive ring services allows you to have several phone numbers on one phone line. Each number is assigned a different ring pattern. You can use one number for voice calls and another for fax calls. Select the ring pattern assigned to fax calls in the DRD Setting. If you select a ring pattern other than **All**, Receive Mode is automatically set to **Auto**.

7. On the Receive Mode Setting screen, do one of the following:
 - If you have connected an external telephone or answering machine to the product, select **Yes** and go to the next step.
 - If you did not connect an external telephone or answering machine, select **No** and go to step 9. (Receive Mode is automatically set to **Auto**; otherwise you cannot receive faxes.)
8. On the next Receive Mode Setting screen, select **Yes** to receive faxes automatically or select **No** to receive faxes manually.

Note: If you connect an external answering machine and select to receive faxes automatically, make sure the **Rings to Answer** setting is correct. If you select to receive faxes manually, you need to answer every call and operate the product's control panel or your phone to receive faxes.

9. On the Proceed screen, confirm the displayed settings and select **Proceed**, or press the back arrow to change the settings.
10. On the Run Check Fax Connection screen, select **Start Checking** and follow the on-screen instructions to check the fax connection and print a report of the check result. If there are any errors reported, try the solutions on the report and run the check again.

If the Select Line Type screen appears, select the correct line type.

If the Dial Tone Detection screen appears, select **Disable**. However, disabling the dial tone detection function may drop the first digit of a fax number and send the fax to the wrong number.

Parent topic: [Setting Up Basic Fax Features](#)

Selecting the Line Type

If you connect the product to a PBX phone system or terminal adapter, you must change the product's line type. PBX (Private Branch Exchange) is used in office environments where an external access code such as "9" must be dialed to call an outside line. The default Line Type setting is PSTN (Public Switched Telephone Network), which is a standard home phone line.

Note: This setting can be locked by an administrator. If you can't access or change this setting, contact your administrator for assistance.

1. Press the  home button, if necessary.
2. Select **Settings > General Settings > Fax Settings > Basic Settings > Line Type > PBX**.

You see a screen like this:

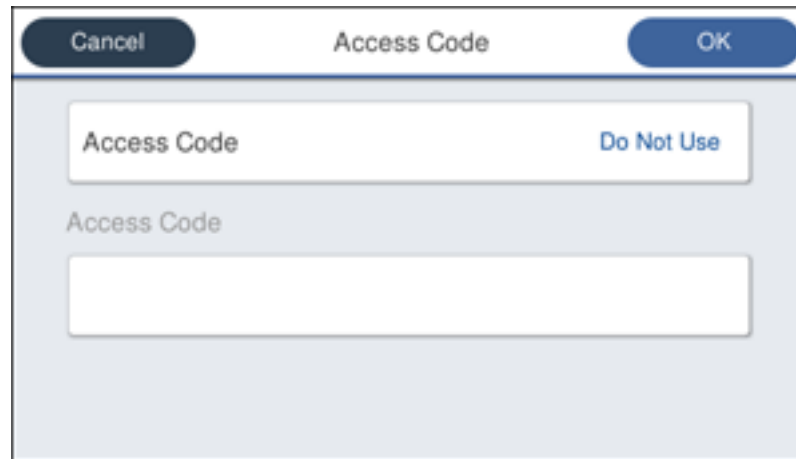

The screenshot shows a dialog box titled "Access Code". At the top left is a "Cancel" button and at the top right is an "OK" button. Below the title bar, there is a section with a label "Access Code" and a "Do Not Use" button. Below that is another "Access Code" label and a large empty text input field.

3. Select **Access Code**.
4. Select **Use**.
5. Select the Access Code field.
6. Use the displayed keypad to enter the access code, such as 9, and select **OK**.

Parent topic: [Setting Up Basic Fax Features](#)

Setting the Number of Rings to Answer

If you connect an external answering machine and select to receive faxes automatically, make sure the Rings to Answer setting is correct. The number of rings should be higher than the number of rings your answering machine is set to for answering a call.

Note: This setting can be locked by an administrator. If you cannot access or change this setting, contact your administrator for assistance.

1. Press the  home button, if necessary.
2. Select **Settings > General Settings > Fax Settings > Basic Settings > Rings to Answer**.

You see a screen like this:



3. Select the number of rings and select **OK**. Make sure to select a number higher than the number of rings your answering machine is set to for answering a call.

Note: An answering machine picks up every call faster than the product, but the product can detect fax tones and start receiving faxes. If you answer the phone and hear a fax tone, check that the product has started receiving the fax, then hang up the phone.

Parent topic: [Setting Up Basic Fax Features](#)

Selecting Advanced Fax Settings

You can select a variety of advanced fax settings.

Note: These settings can be locked by an administrator. If you cannot access or change these setting, contact your administrator for assistance.

1. Press the  home button, if necessary.
2. Select **Settings > General Settings > Fax Settings**.

You see a screen like this:

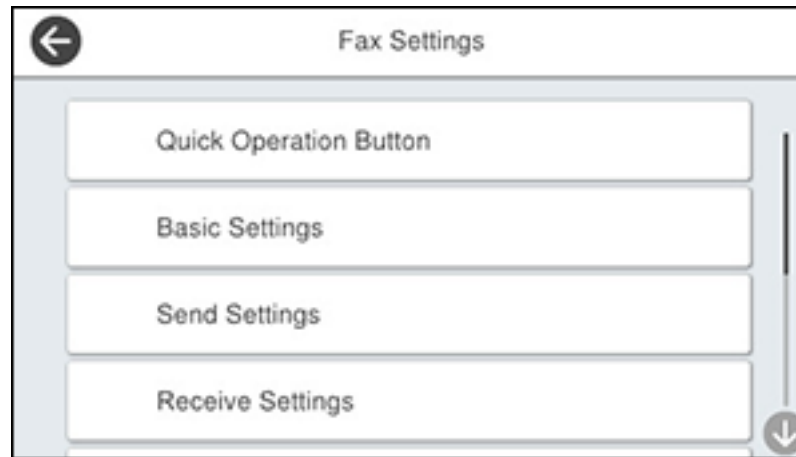

3. Select the group of settings you want to change.

[Basic Settings - Fax](#)

[Send Settings - Fax](#)

[Receive Settings - Fax](#)

[Report Settings - Fax](#)

[Security Settings - Fax](#)

Parent topic: [Setting Up Fax Features](#)

Basic Settings - Fax

Set the basic options you want to use for incoming and outgoing faxes.

Note: If the optional fax board is installed on your product, the **Expansion Line Settings** menu appears. You can select certain settings below for each added line.

Setting	Options	Description
Fax Speed	Fast(33,600bps)	Sets the speed at which you send and receive faxes.
	Medium(14,400bps)	
	Slow(9,600bps)	

Setting	Options	Description
ECM	On	Turns on Error Correction Mode (ECM) to automatically correct errors in sent or received fax data.
	Off	Turns off Error Correction Mode (ECM); color faxes cannot be sent or received.
Dial Tone Detection	On	Automatically dials the number you enter for faxing when the product detects a dial tone.
	Off	Turns off automatic dial tone detection, which may be necessary if the product is connected to a PBX (Private Branch Exchange) or a TA (Terminal Adapter). However, turning this setting off may cause the product to drop the first digit of a fax number.
Line Type	PSTN	Selects a standard phone line (Public Switched Telephone Network).
	PBX	Selects Private Branch Exchange, the type of phone line used in office environments where an access code such as 9 must be used to call an outside line.
Header	Your Phone Number	Select to enter the header information and your phone number for inclusion on outgoing faxes.
	Fax Header	
Receive Mode	Manual	Lets you confirm whether an incoming fax should be printed; a telephone must be connected to the product
	Auto	Automatically receives and prints faxes.
Distinctive Ring	All	If you are using a Distinctive Ring Service on your phone line, your telephone company can assign two or more phone numbers to the same line and assign different ring patterns to each. If you use this service, select the number of rings for your fax number so your product can receive faxes on the correct number of rings. Select All for phones lines that do not use this service.
	Single	
	Double	
	Triple	
	Double&Triple	

Setting	Options	Description
Rings to Answer	1 to 9	Sets the number of rings before your product receives a fax. If Receive Mode is set to Auto and an answering machine is connected to the product, make sure this setting is set higher than the number of rings your answering machine is set to answer a call.
Remote Receive	Off	Lets you start receiving faxes using your phone instead of operating the product (if the Receive Mode is set to Auto). When you select On , you must also set a Start Code . If you are using a cordless handset with its base connected to the product, you can start receiving the fax by entering the code using the handset.
	On	
	Start Code	
Rejection Fax	Various	Lets you automatically reject faxes from blocked numbers, with blank headers, or from unrecognized contacts.
Save/Forward File Format	PDF	Saves or forwards a fax as a PDF file. You can also set a password for opening the PDF or allowing printing and editing permissions.
	TIFF	Saves or forwards a fax as a TIFF file.
Cloud Destination List	Various	Allows user to register up to five addresses at a cloud service recognized by Epson Connect. Received faxes may be forwarded to the selected cloud service. To use this feature, the printer must be registered with Epson Connect.

Parent topic: [Selecting Advanced Fax Settings](#)

Related tasks

[Starting a Scan Using the Product Control Panel](#)

[Selecting the Date and Time](#)

Related topics

[Setting Up Contacts and Contact Groups](#)

Send Settings - Fax

Set the send options you want to use for outgoing faxes.

Setting	Options	Description
Batch Send	Off	Sorts outgoing faxes by recipient in the product's memory, and then sends them as a batch. Up to five documents (200 pages total) can be sent at one time.
	On	
Save Failure Data	Off	Saves faxes that failed to be sent in the product's memory. You can resend the faxes from the product's Job/Status menu. When you select On , you can select a time period to store the saved faxes.
	On	
Wait Time for Next Original	Off	Sets a time in between sending the next fax
	On	
Fax Preview Display Time	Off	Sets a time for previewing the scanned document on the LCD screen before it is sent
	On	
Allow Backup	Allowed	Allows you to back up sent faxes. Select Fax > Fax Settings > Backup to view backed up faxes.
	Not Allowed	

Parent topic: [Selecting Advanced Fax Settings](#)

Receive Settings - Fax

Set the save/forward or print options you want to use for incoming faxes.

Save/Forward Settings

Setting	Options	Description
Unconditional Save/Forward	Save to Inbox	Saves received faxes in printer's inbox
	Save to Computer	Converts received faxes to PDFs and saves them on a computer connected to the printer
	Save to Memory Device	Converts received faxes to PDFs and saves them on an external memory device connected to the printer
	Forward	Forwards received faxes to another fax machine, or converts them to PDFs and forwards them to a shared folder on a network or an email address. Forwarded faxes are deleted from the printer.
	Email Notifications	Sends an email notification after a fax is received, printed, saved, or forwarded
Conditional Save/Forward	—	Sets up conditions to save, forward, or print received faxes. Select Enable to enable a condition. Select the arrow icon to enter conditions and other settings.
Common Settings	Inbox Settings	Sets up what happens when the fax memory is full, or sets up a password for the inbox. You cannot set a password if the Options when memory is full setting has been set to Receive and print faxes .
	Email Subject to Forward	Specifies a subject when forwarding a fax to an email address
	Box Document Delete Settings	Select On to automatically delete received faxes after a set period of time

Print Settings

Setting	Options	Description
Auto Reduction	On	Select to reduce the size of large received faxes to fit on the paper size in the selected paper source.
	Off	Select to print large incoming faxes at their original size on multiple sheets, if necessary.

Setting	Options	Description
Split Page Settings	Delete Print Data After Split	Select how to split large incoming faxes across multiple sheets when using the Auto Reduction option.
	Overlap When Split	
Acting Print	On (Split to Pages)	Select to split large incoming faxes across multiple sheets.
	On (Reduce to Fit)	Select to reduce the size of large received faxes to fit on the paper size in the selected paper source.
	Off	Select to print large incoming faxes at their original size on multiple sheets, if necessary.
Auto Rotation	On	If you have loaded A5-size paper, select On to rotate landscape-oriented incoming faxes so that they print correctly on the paper.
	Off	
Add Reception Information	On	Select On to include the date, time, the sender's information, and a page number in the header of your incoming faxes.
	Off	
2-Sided	On	Select On to print incoming faxes double sided. You can also select the Binding Margin .
	Off	
Print Start Timing	All Pages Received	Select to print incoming faxes after the product receives all of the pages of the document.
	First Page Received	Select to print incoming faxes as soon as the product receives the first page of the document.
Collation Stack	On	Select On to print incoming faxes so that the pages are stacked in the correct page order. (When the product is low on memory, this option may not be available.)
	Off	
Print Suspend Time	Off	Select On to set a time period to stop automatic printing of faxes or reports and save received faxes in the product's memory. (Make sure there is enough free memory before using this function.)
	On	
	Time to Stop	
	Time to Restart	

Setting	Options	Description
Quiet Mode	On	Select On to reduce noise during printing (printing speed may be reduced).
	Off	

Parent topic: [Selecting Advanced Fax Settings](#)

Report Settings - Fax

Set the options you want for fax reports.

Setting	Options	Description
Forwarding Report	Print on Error	Prints a report after forwarding a received document only if an error occurs
	Print	Prints a report after forwarding a received document
	Do Not Print	Does not print a report after forwarding a received document
Backup Error Report	On	Select On to print a report when a backup error for sending faxes occurs
	Off	
Fax Log Auto Print	Off	Does not print a fax log
	On(Every 100)	Prints a fax log after every 100 fax jobs are completed
	On(Time)	Prints a fax log at a specified time. If the number of completed fax jobs exceeds 30, the fax log prints before the specified time.
Reception Report	Print on Error	Prints a report after receiving a fax only if an error occurs
	Print	Prints a report after receiving a fax
	Do Not Print	Does not print a report after receiving a fax

Setting	Options	Description
Attach Fax Image to Report	Off	Does not include an image on the Transmission Report
	On(Large Image)	Prints a Transmission Report that includes the upper part of the first page of the sent document
	On(Small Image)	Prints a Transmission Report that includes a reduced size of the entire first page of the sent document
Fax Log Layout	Combine Send and Receive	Prints a Transmission Report and a Reception Report on the same sheet when you print a fax log
	Separate Send and Receive	Prints a Transmission Report and a Reception Report on separate sheets when you print a fax log
Report Format	Simple	Prints a simple fax report
	Detail	Prints a fax report that includes error codes
Fax Log Output Method	Print	Prints fax reports
	Save to Memory Device	Saves fax reports to an inserted memory device. Select Create a folder to save fax data to create a folder on the inserted memory device.
	Forward	Forwards fax reports to a specified destination

Parent topic: [Selecting Advanced Fax Settings](#)

Security Settings - Fax

Set the security options you want to use for fax data.

Setting	Options	Description
Direct Dialing Restrictions	Off	Does not restrict dialed fax numbers.
	On	Allows faxing only to numbers stored in the contacts list or history.
	Enter Twice	Requires you to enter fax numbers twice to prevent errors.
Broadcasting Restrictions	Off	Select On to allow only one fax number to be entered as the recipient
	On	



Setting	Options	Description
Confirm Address List	Off	Selects whether or not to display a recipient confirmation screen before a fax is sent.
	On	
Backup Data Auto Clear	Off	Automatically erases sent or received fax data from your product's memory.
	On	
Clear Backup Data	—	Deletes all sent or received fax data remaining in your product's memory; run this function if you are giving away or disposing of your product.

Parent topic: [Selecting Advanced Fax Settings](#)

Setting Up the Fax Utility - Windows

You can set up the FAX Utility for Windows for use with your product.

Note: Before using the FAX Utility for Windows, make sure you have set up the fax features on your product using the product control panel. Also first confirm that you can send and receive faxes using the control panel.

1. Do one of the following:
 - **Windows 11:** Click , then search for **EPSON Software** and select it.
 - **Windows 10:** Click  and select **EPSON Software**.
 - **Windows 8.x:** Navigate to the **Apps** screen.
 - **Windows (other versions):** Click  or **Start > Programs** or **All Programs > EPSON Software**.
2. Select **FAX Utility**.

The first time you use the FAX Utility, you see this introduction window:

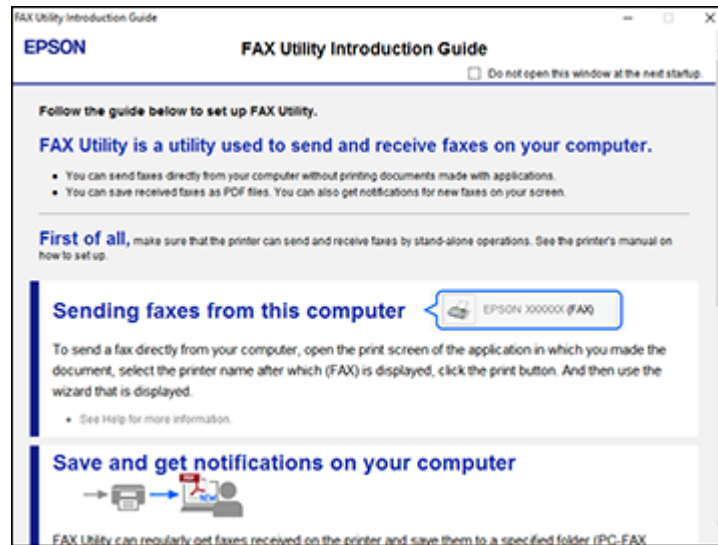

3. Read about the FAX Utility and click **Return to the main window** at the bottom of the window.

You see this window:

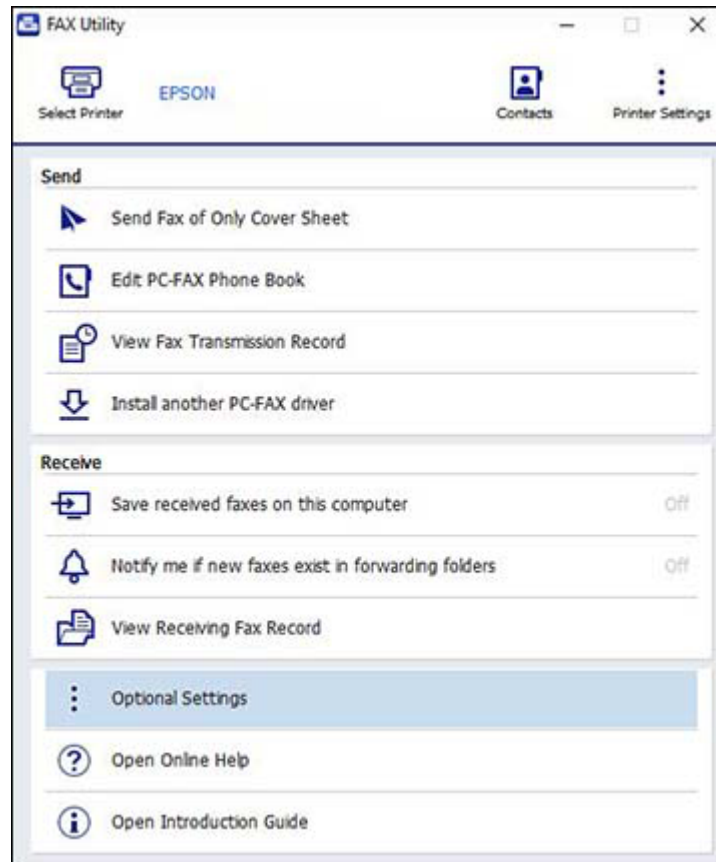

4. Click **Select Printer** and follow the on-screen instructions to transfer your product's fax settings to the FAX Utility.

Note: For detailed information, click **Help** or **Open Online Help**.

Parent topic: [Setting Up Fax Features](#)

Setting Up Fax Features Using the Fax Utility - Mac

You can set up your fax header and select your fax settings using the FAX Utility for Mac.

1. In the Apple menu or the Dock, select **System Preferences**. Select **Print & Fax**, **Print & Scan**, or **Printers & Scanners**, select the **FAX** option for your product, and select **Options & Supplies**. Select **Utility** and select **Open Printer Utility**.
2. Double-click **FAX Utility**, if necessary.

You see a window like this:

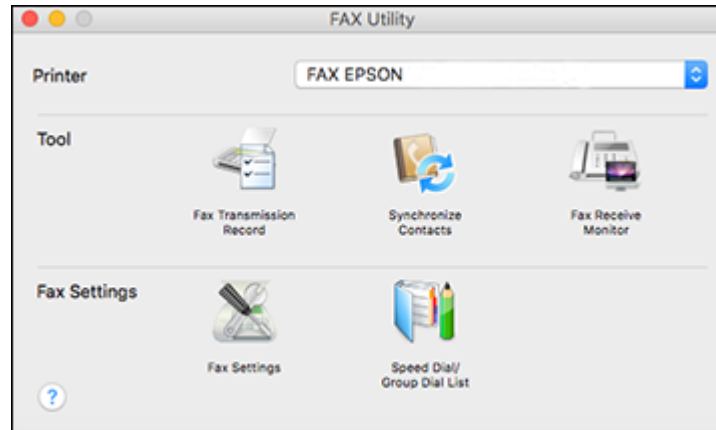

3. Select your **FAX** product in the Printer list.
4. Select **Fax Settings**.
5. Follow the prompts that appear on the screen to enter your fax header information and select your fax settings.

Note: For detailed information, select the FAX Utility ? icon.

Parent topic: [Setting Up Fax Features](#)

Setting Up Contacts and Contact Groups

You can set up a list of contacts and their fax numbers so you can quickly select them for faxing. You can also set up contact groups to send a fax message to multiple contacts.

Note: Contacts can be locked by an administrator. If you cannot access or change contacts, contact your administrator for assistance.



[Creating a Contact](#)
[Editing or Deleting a Contact](#)
[Creating a Contact Group](#)
[Editing or Deleting a Contact Group](#)

Parent topic: [Faxing](#)

Creating a Contact

You can create a list of contacts to save frequently used fax numbers.

Note: You can create up to 200 contacts and contact groups combined.

1. Press the  home button, if necessary.
2. Select **Fax**.
3. Select **Contacts**. Enter the administrator password, if necessary.
4. Select the  icon.
5. Select **Add Contact**.
6. Select the registry number you want to use for the contact you are adding.
7. Select the **Name** field, use the displayed keyboard to enter the contact name (up to 30 characters), and select **OK**.
8. Select the **Index Word** field, use the displayed keyboard to enter a word to use when searching for an entry (up to 30 characters), and select **OK**.

Note: This field is automatically populated after you enter the name. This field is optional.

9. Select the **Fax Number** field, and use the numeric keypad on the LCD screen or the buttons on the product to enter the fax number. You can enter up to 64 characters. Select **OK** when you are done.



Note: If necessary, enter an outside line access code (such as **9**) at the beginning of the fax number. If the access code has been set up in the **Line Type** setting, enter the **#** pound sign instead of the code.

10. Set the **Fax Speed**, **Subaddress**, and **Password** settings, if necessary.
11. Select **OK**.

Parent topic: [Setting Up Contacts and Contact Groups](#)

Editing or Deleting a Contact

You can edit or delete any of the contacts on your list.



1. Press the  home button, if necessary.
2. Select **Fax**.
3. Select **Contacts**. Enter the administrator password, if necessary.
4. Select the  icon next to the contact you want to edit or delete.
5. Do one of the following:
 - To delete the contact, select **Delete** and select **Yes** on the confirmation screen.
 - To edit the contact, select **Edit**, select the item you want to change, enter the correct information, and select **OK**. When you are finished editing, select **OK**.

Parent topic: [Setting Up Contacts and Contact Groups](#)

Creating a Contact Group

You can create a group of contacts so that you can easily send faxes to multiple recipients.

Note: You can create up to 200 contacts and contact groups combined.

1. Press the  home button, if necessary.
2. Select **Fax**.
3. Select **Contacts**. Enter the administrator password, if necessary.
4. Select the  icon.
5. Select **Add Group**.
6. Select the registry number you want to use for the group you are adding.
7. Select the **Group Name** field, use the displayed keyboard to enter the group name (up to 30 characters), and select **OK**.

8. Select the **Index Word** field, use the displayed keyboard to enter a word to use when searching for a group (up to 30 characters), and select **OK**.



Note: This field is automatically populated after you enter the group name. This field is optional.

9. Select **Contact(s) Added to the Group**.
You see your contacts list.
10. Select each contact you want to include in your group.
Each selected contact is highlighted.
11. Select **Close**.
12. Select **OK**.

Parent topic: [Setting Up Contacts and Contact Groups](#)

Editing or Deleting a Contact Group

You can edit an existing contact group to add or delete entries. You can also delete the entire contact group.

1. Press the  home button, if necessary.
2. Select **Fax**.
3. Select **Contacts**. Enter the administrator password, if necessary.
4. Select the  icon next to the group you want to edit or delete.
5. To edit the group, select **Edit**.
6. Select **Contact(s) Added to the Group**.
You see a list of the contacts in your group.
7. Select the contact you want to add or delete.
Each selected contact is highlighted.
8. Select **Close**.
9. Select **OK**.

Parent topic: [Setting Up Contacts and Contact Groups](#)

Sending Faxes

See these sections to send faxes using your product.

[Sending Faxes from the Product Control Panel](#)

[Sending Faxes Using the Fax Utility - Windows](#)

[Sending Faxes Using the Fax Utility - Mac](#)

Parent topic: [Faxing](#)

Sending Faxes from the Product Control Panel

See these sections to send faxes using the product's control panel.

[Sending a Fax Using the Keypad, Contact List, or History](#)

[Fax Sending Options](#)

[Sending a Fax at a Specified Time](#)

[Sending a Fax on Demand](#)

[Sending a Stored Fax](#)

[Dialing Fax Numbers from a Connected Telephone](#)

Parent topic: [Sending Faxes](#)

Sending a Fax Using the Keypad, Contact List, or History

You can send a fax from your product control panel by entering the fax number, or selecting the number from either the contact list or fax history.

Note: You can send a black-and-white fax to up to 200 recipients at a time, or send a color fax to one recipient at a time. If your recipient's fax machine does not print in color, your fax is automatically sent in black-and-white.

Note: The product can queue up to 50 black-and-white fax jobs. You can check or cancel fax jobs in the queue using the **Job/Status** menu.

1. Place your original on the product for faxing.
2. Press the  home button, if necessary.
3. Select **Fax**.

Note: To fax a double-sided document, place your document in the ADF and turn on the **ADF 2-Sided** setting. (You cannot fax double-sided documents in color.)

4. Do one of the following to select fax recipients:

- Select **Keypad** and enter a fax number. Select **OK** when done. To add another fax number, repeat the same steps. You can also use the numeric keypad on the control panel to enter a fax number.

Note: If direct dialing has been restricted, you can only select the number from the contact list or fax history. If necessary, enter an outside line access code (such as 9) at the beginning of the fax number. If the access code has been set up in the **Line Type** setting, enter the # pound sign instead of the code. If your fax number requires a brief pause, select the  icon to insert a pause symbol (–).

- Select **Contacts** to display the contact list. Select one or more contacts (select the contact again to deselect it). You can also select the **Search for Contacts** field to search for recipients by name, index name, or entry number. Select **Close** when you are finished.
- Select **Recent** to display the sent fax history.

Note: To delete entered recipients, select the **Select Recipient** field, select the recipient you want to delete, and select **Remove**.

5. If you need to change any fax settings, select **Fax Settings** and select your settings.

6. If you want to preview your fax in black-and-white on the LCD, press the  **Preview** icon. (If the preview looks incorrect, select **Cancel**, reposition the document or change the fax settings, and repeat this step.)

Note: If you do not touch the preview screen for 20 seconds, your product sends the fax automatically. You cannot preview images when the Direct Send setting is turned on.

7. If you want to save your fax settings for later use, select **Presets** and add a new entry.

8. Select the  **Send** icon.

Note: To cancel faxing, select the  cancel button. You can also cancel the job or check the job status from the **Job/Status** menu.

Your product scans your original and prompts you to place additional pages, if necessary. After scanning your originals, your product dials the number and sends the fax.

Note: Your product does not save sent color faxes to its memory. If the **Save Failure Data** option is enabled, faxes that failed to be sent are stored to the product's memory and you can resend them from the **Job/Status** menu.

Parent topic: [Sending Faxes from the Product Control Panel](#)

Related references

[Fax Sending Options](#)

Related tasks

[Selecting the Line Type](#)

[Using Presets](#)

Related topics

[Setting Up Contacts and Contact Groups](#)

[Placing Originals on the Product](#)

Fax Sending Options

While sending a fax, you can select **Fax Settings** and select these options.

Setting	Options	Description
Resolution	Standard	Adjusts the scan resolution and print quality of outgoing faxes
	Fine	
	Super Fine	
	Ultra Fine	
Density	Varying levels available	Lets you select from various density levels
Original Type	Text	Specifies the document type of your originals and adjusts the quality of your copies
	Text & Image	
	Photo	
Remove Background	Auto	Automatically removes any background color on scanned images
	Varying levels available	Lets you select from various levels of background color adjustment

Setting	Options	Description
Sharpness	Varying levels available	Lets you adjust the sharpness level of outgoing faxes
ADF 2-Sided	Off	Select On to enable 2-sided faxing from the ADF. The Direct Send option and color faxing are disabled when you turn on this setting.
	On	
Continuous Scan (ADF)	Off	Select On to have the product to ask if you want to scan another page after a document in the ADF has finished scanning
	On	
Original Size (Glass)	Varying sizes	Select the size for a document placed on the scanner glass, or select Auto Detect to have the product automatically detect the size of the document.
	Auto Detect	
Color Mode	B&W	Select whether to scan images in color or black and white
	Color	
Direct Send	Off	Select On to send black-and-white faxes to a single recipient as soon as the connection is made, without saving the scanned image to memory. You cannot use this setting when sending a color fax or sending a fax to multiple recipients.
	On	
Priority Send	Off	Select On to send the current fax before other faxes waiting to be sent
	On	
Send Fax Later	Off	Select On to send the current monochrome fax at a selected time
	On	
Add Sender Information	Off	Lets you include a header, your phone number, or a destination list in the selected location on your outgoing faxes
	Outside of Image	
	Inside of Image	
Notify Send Result	Off	Sends a notification to the selected email address when an outgoing fax is sent
	On	
Transmission Report	Print on Error	Lets you select when to print transmission reports
	Print	
	Do Not Print	



Setting	Options	Description
Backup	Off	Saves a copy of the scanned fax to the selected email address or network folder/FTP location
	On	

Parent topic: [Sending Faxes from the Product Control Panel](#)

Sending a Fax at a Specified Time

You can send a fax at a time of your choice.

Note: Make sure the product's date and time settings are correct. You can only send faxes in black-and-white when you use this option.

1. Place your original on the product for faxing.
2. Press the  home button, if necessary.
3. Select **Fax**.
4. Enter a fax number or select a number from the **Contacts** or **Recent** lists.
5. Select **Fax Settings**.
6. Select **Send Fax Later**.
7. Select **On**.
8. Select **Time**, use the displayed keypad on the LCD screen to enter your desired time, and select **OK**.
9. Select the  **Send** icon.

Note: To cancel faxing, select the  cancel button.

After scanning your originals, your product dials the number and sends the fax at the specified time.

Note: If the product is turned off at the specified time, the fax is sent when it is powered on.

Parent topic: [Sending Faxes from the Product Control Panel](#)

Related references

[Fax Sending Options](#)

Related tasks

[Selecting the Date and Time](#)



Related topics

[Setting Up Contacts and Contact Groups](#)

[Placing Originals on the Product](#)

Sending a Fax on Demand

You can store one scanned document (up to 100 black-and-white pages) and have it sent automatically when another fax machine requests it. Other fax users can receive the document by calling your fax number and using the polling receive function on their fax machines.

1. Place your original on the product for faxing.
2. Press the  home button, if necessary.
3. Select **Fax Box**.
4. Select **Polling Send/Board**.
5. Select **Polling Send**.
6. Review the displayed Polling Send Box settings. If you need to make changes, select the  icon and select **Settings**. Make any necessary changes and select **OK**.
7. Select **Add Document**.
8. Review the displayed Fax Settings. Make any necessary changes.
9. Select the  **Store** icon.

Your document is scanned and stored until you overwrite or delete it.

You can store only one document at a time. Subsequent documents overwrite the existing document. You can also delete a stored document from the **Job/Status** menu.

Parent topic: [Sending Faxes from the Product Control Panel](#)

Related references



[Fax Sending Options](#)

Related topics



[Placing Originals on the Product](#)

Sending a Stored Fax

You can store up to 10 black-and-white scanned documents (200 pages total) and send them whenever necessary.

1. Place your original on the product for faxing.
2. Press the  home button, if necessary.
3. Select **Fax**.
4. Select the  icon.
5. Select **Extended Fax**.
6. Select **Store Fax Data** and select **On**.
7. Select **Close**.
8. Select any other fax settings as necessary and select **Close**.
9. Select the  **Store** icon.

Your document is scanned, stored, and briefly previewed.

10. When you are ready to send the document, press the  home button, if necessary, and select **Fax Box**.
11. Select **Stored Documents**.
12. Select the stored fax job you want to send.
13. Select the  **Send** icon.

The selected fax is sent.

Parent topic: [Sending Faxes from the Product Control Panel](#)

Related references

[Fax Sending Options](#)

Related topics

[Placing Originals on the Product](#)

Dialing Fax Numbers from a Connected Telephone

If you have connected a telephone to the **EXT** port on your product, you can send a fax by dialing the fax number from the connected telephone. If the recipient's phone number and fax number are the same, you can speak to the recipient before sending the fax.

1. Place your original on the product for faxing.
2. Press the  home button, if necessary.
3. Dial the fax number from the connected telephone. Speak to the recipient if necessary.

Note: If you are using a pre-paid calling card, enter the number and password required to use the card before entering the destination fax number.

4. Select **Fax** on the LCD screen.
5. Select **Fax Settings** and select any settings as necessary.

Note: Your product now communicates with the recipient's fax machine. Do not hang up the telephone.

6. When you hear a fax tone, select the  **Send** icon to start sending the fax.

Note: If your recipient's fax machine does not print in color, your fax is automatically sent in black-and-white.

7. Hang up the telephone.

Parent topic: [Sending Faxes from the Product Control Panel](#)

Related references

[Fax Sending Options](#)

Related topics

[Placing Originals on the Product](#)

Sending Faxes Using the Fax Utility - Windows

You can send a fax from a printing program in Windows. You can fax up to 100 pages at a time, including a cover sheet.

1. Open the file you want to fax and select the print command.

You see a window like this:

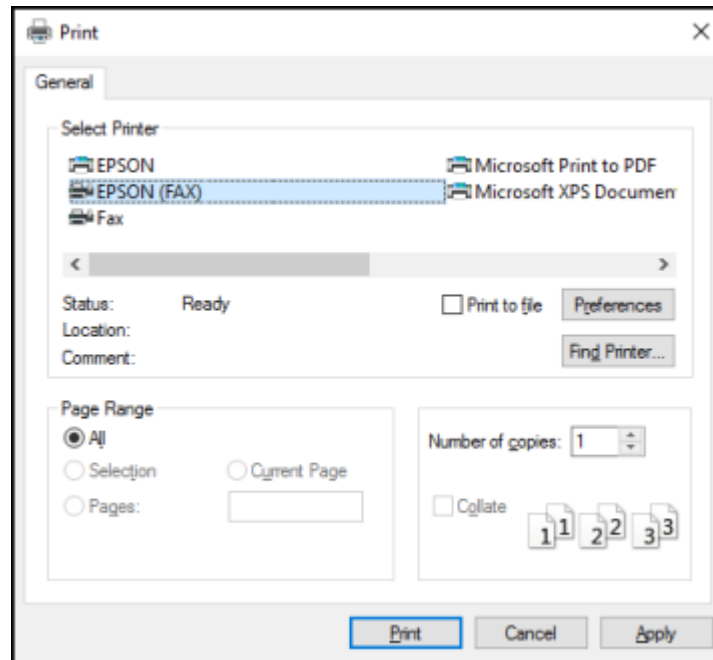

2. Select your product with the **FAX** option as the printer.
3. To change the Paper Size, Orientation, Color, Image Quality, or Character Density settings, click the **Preferences** or **Properties** button.

Note: If you see a **Setup**, **Printer**, or **Options** button, click it. Then click **Preferences** or **Properties** on the next screen. For more information about selecting fax print settings, click **Help**.

4. Select the Page Range as necessary. (Leave the Number of copies set to 1.)
5. Click **Print** or **OK**.

If you're faxing for the first time, you see a window like this one:

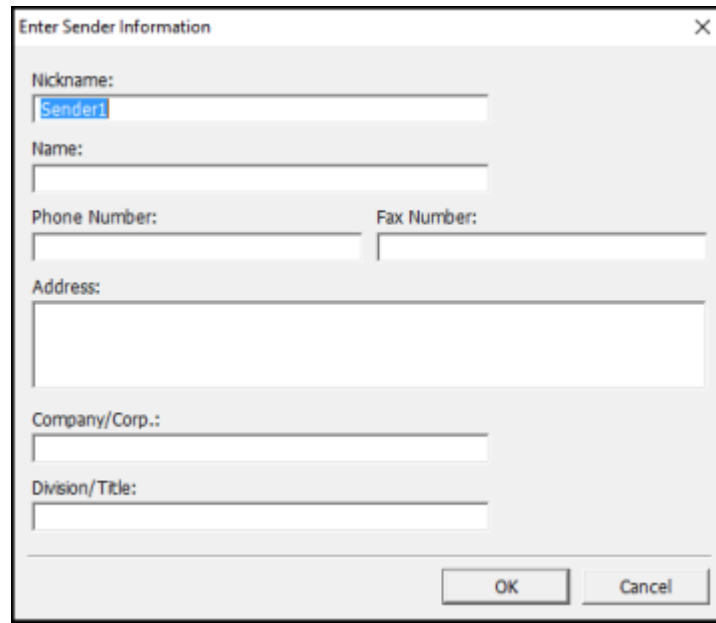

The image shows a dialog box titled "Enter Sender Information" with a close button (X) in the top right corner. The dialog contains several input fields: "Nickname:" with the text "Sender1" entered; "Name:" which is empty; "Phone Number:" and "Fax Number:" which are empty; "Address:" which is a large empty text area; "Company/Corp.:" which is empty; and "Division/Title:" which is empty. At the bottom right, there are two buttons: "OK" and "Cancel".

6. Enter your sender information so that recipients can identify the origin of the fax. Then click **OK** to save the sender information.

You see a window like this:

Recipient Settings (1 / 3)

Recipient List: Recipient Total: 0

Name/Group Name	Fax Number	Company/Corp.	Division/Title
-----------------	------------	---------------	----------------

Add Delete

Phone Book | Manual Dial

Name: Fax Number:

Title: Because "-" acts as a pause, do not use it to punctuate phone numbers.

Company/Corp.: Division/Title:

Save to Phone Book... Clear

< Back Next > Cancel Help

7. Enter the recipient's name and fax number or select a recipient from the phone book, then click **Next**.

Note: For detailed instructions on using the Epson FAX Utility, click **Help**.

8. Select a cover sheet and enter a subject and message, then click **Next**.
9. Click **Send** to transmit your fax.

Parent topic: [Sending Faxes](#)

Sending Faxes Using the Fax Utility - Mac

You can send a fax from a Mac printing program using the FAX Utility. You can fax up to 100 pages at a time, including a cover sheet.

1. Open the file you want to fax.
2. Select the print command in your application.

Note: You may need to select a print icon on your screen, the **Print** option in the **File** menu, or another command. See your application's help utility for details.

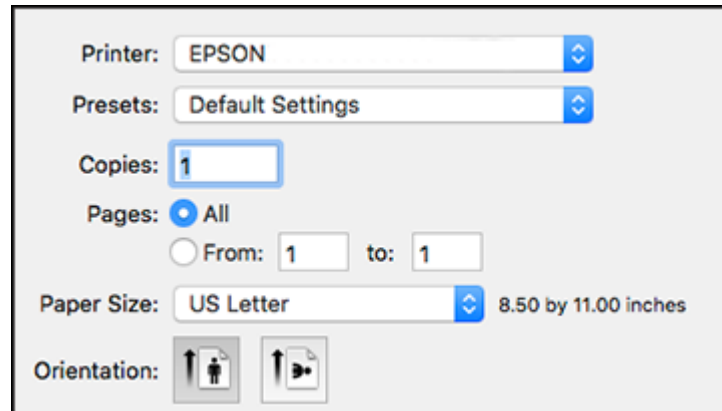

Note: The print window may look different, depending on the Mac OS version and the application you are using.

3. Select your product **FAX** option as the **Printer** setting.
4. If necessary, click the arrow next to the Printer setting or the **Show Details** button to expand the print window.
5. Select the number of pages you are faxing as the **Pages** setting.

Note: Leave the **Copies** setting set to 1.

6. Select **Recipient Settings** from the pop-up menu.

You see this window:

Recipient Settings

Recipient List:

Name	Company/Corp.	Fax Number
------	---------------	------------

Add:

Name:

Company/Corp.:

Fax Number:

A hyphen (-) is available only at the beginning of the phone number because it acts as a pause in dialing.

External Access Prefix:

Cancel Fax

7. Do one of the following to choose your recipient:
 - Select a name or group from the **Recipient List**.
 - Enter a name, company, and fax number and click the **+** button.
 - Click the  icon and select a recipient from your address book.
8. Select **Fax Settings** from the pop-up menu.

You see this window:

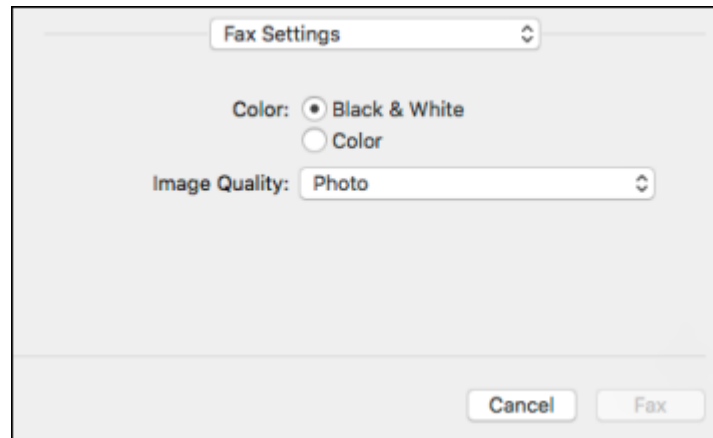

9. Select the **Color** and **Image Quality** settings you want to use for your fax.
10. Click **Fax**.

Parent topic: [Sending Faxes](#)

Receiving Faxes

See these sections to receive faxes with your product.

[Fax Reception](#)

[Receiving Faxes Automatically](#)

[Receiving Faxes Manually](#)

[Forwarding Received Faxes](#)

[Receiving a Fax by Polling](#)

Parent topic: [Faxing](#)

Fax Reception

Your product will automatically receive and print faxes when you set the Receive Mode to **Auto**.

If you connected a telephone to your product so you can use the same phone line for faxes and voice calls, you can also set your product to receive faxes manually. This allows you to check for a fax tone using the telephone and press a button on your product to receive the fax.

Make sure to load paper in your product and select your fax settings before receiving a fax.

Note: If you run out of paper during fax printing, load more paper and press the button indicated on your product's LCD screen to continue.

Parent topic: [Receiving Faxes](#)

Receiving Faxes Automatically

To receive faxes automatically, make sure Receive Mode is set to **Auto** (the default setting for the product).

To change the Receive Mode if necessary, select **Settings > General Settings > Fax Settings > Basic Settings > Receive Mode**.

If an answering machine is connected, make sure the product's **Rings to Answer** setting is set higher than the number of rings your answering machine is set to answer a call. For example, if the answering machine is set to pick up on the fourth ring, set the product to pick up on the fifth ring or later.

Parent topic: [Receiving Faxes](#)

Related references

[Basic Settings - Fax](#)

Related tasks

[Receiving Faxes Manually](#)

Receiving Faxes Manually

You can set up your product to receive faxes manually by setting the Receive Mode to **Manual**. This lets you check for a fax tone on the connected telephone before receiving a fax.

1. To change the Receive Mode, select **Settings > General Settings > Fax Settings > Basic Settings > Receive Mode** and select **Manual**.
2. When the connected telephone rings, answer the call.
3. If you hear a fax tone, select **Fax** on the LCD display.
4. Select **Send/Receive**.
5. Select **Receive**.
6. Select the  **Receive** icon to start receiving the fax.
7. Hang up the telephone.

Parent topic: [Receiving Faxes](#)

Related references

[Basic Settings - Fax](#)

Related tasks

[Receiving Faxes Automatically](#)

Forwarding Received Faxes

You can forward received faxes to another fax machine, or convert the faxes into PDF documents and forward them to a shared folder on the network or to an email address. Forwarded faxes are deleted from the product's memory. Before using this feature, make sure the date and time are set correctly, the forwarding destination is set up in the contact list, and the email server settings are configured.

1. Press the  home button, if necessary.
2. Select **Settings** > **General Settings** > **Fax Settings** > **Receive Settings** > **Save/Forward Settings** > **Unconditional Save/Foward** > **Forward** > **Yes**.

Note: If you want to print the fax automatically before forwarding it, select **Yes and Print**.



3. Select **Add Entry** and select the forwarding destinations from the contacts list.
4. When you are finished selecting your forwarding destinations, select **Close**.
5. Confirm the displayed forwarding destinations and select **Close**.
6. Select an **Options When Forwarding Failed** option to choose whether you want to print the faxes or save them in the printer's inbox if forwarding received faxes fails.

Parent topic: [Receiving Faxes](#)

Receiving a Fax by Polling

You can use polling to receive a fax from another fax machine (such as a fax information service).

Note: You cannot use polling to receive a fax from a fax information service that uses audio guidance.

1. Press the  home button, if necessary.
2. Select **Fax**.
3. Select the  icon.



4. Select **Extended Fax**.
5. Set **Polling Receive** to **On**.
6. Select **Close**.
7. Select **Close**.
8. Enter the fax number you expect to receive the fax from.
9. Select the  **Polling** icon to start receiving the fax.

Parent topic: [Receiving Faxes](#)

Checking Fax Status

You can check the status of current fax jobs, or faxes that have been received or sent on the product control panel.

1. Press the  **Job/Status** button. Select the **Job/Status** tab if necessary.
2. Do one of the following:
 - To check the status of current fax jobs, select the fax job you want to check.
 - To check the history of faxes that have been sent, received, or saved, select **Log** and select the job you want to check.

Note: If you see a numbered icon above the  icon on your product's LCD screen or the  **Received Fax** light is flashing, received faxes have been temporarily saved to the product's memory.



Parent topic: [Faxing](#)

Viewing a Fax on the LCD Screen (Using the Fax Box)

You can save received faxes in your product's memory and view them on the LCD screen.

Note: The Inbox can be locked by an administrator. If you cannot access the Inbox, contact your administrator for assistance.

1. Press the  home button, if necessary.
2. Select **Settings** > **General Settings** > **Fax Settings** > **Receive Settings** > **Save/Forward Settings** > **Unconditional Save/Forward**.



3. Set **Save to Inbox** to **On**.
4. Press the  home button.
5. Select **Fax Box**.
6. Do one of the following:
 - Select **Inbox/Confidential** to view received documents.
 - Select **Stored Documents** to view saved documents that have not been sent when **Store Fax Data** is set to **On**.
 - Select **Polling Send/Board** to view documents that are stored for fax polling.
7. Select the fax you want to view.
You see the fax displayed on the screen.
8. Select the  icon.
9. Select one of the printing or deleting options, and follow the on-screen instructions.

Note: Delete faxes after you print or view them to prevent the product's memory from filling up. When the memory is full, you can only forward or print incoming faxes.

Parent topic: [Faxing](#)

Printing Fax Reports

You can print several types of fax reports whenever necessary. You can also print the fax log printed automatically by turning on **Fax Log Auto Print**.

1. Press the  home button, if necessary.
2. Select **Fax**.
3. Select the  icon.
4. Select **Fax Report**.
5. Select the fax report you want to print.

[Fax Report Options](#)

Parent topic: [Faxing](#)

Fax Report Options

Select the fax report or list you want to print.

Last Transmission

Print a report on the previous fax that was sent or received through polling.

Fax Log

View or print a report on recent fax transmissions.

Stored Fax Documents

Print a list of the fax jobs currently stored in the product's memory.

Fax Settings List

Print a list of the current fax communication settings.

Conditional Save/Forward List

Print a list of the current conditional save/forward settings.

Protocol Trace

Print a detailed report for the previous sent or received fax.

Parent topic: [Printing Fax Reports](#)

Using External USB Devices with Your Product

Follow the instructions here to work with an external USB device connected to your product.

[Connecting a USB Device](#)

[Disconnecting a USB Device](#)

[Viewing and Printing from the LCD Screen](#)

[Transferring Files on a USB Device](#)

Connecting a USB Device

Connect a USB device or its USB cable to the USB port on the front of the product.

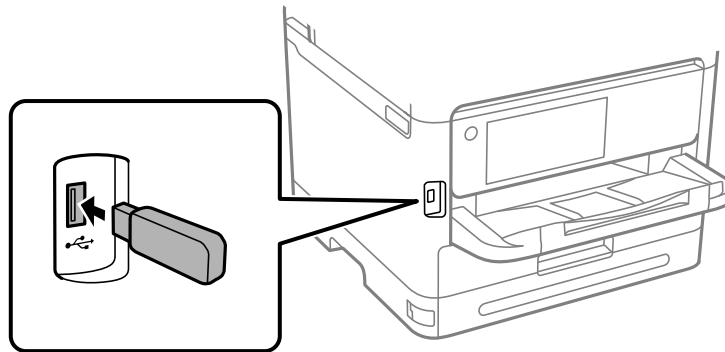

Note: Epson cannot guarantee the compatibility of your device. Make sure the files on the device are compatible with the product.

Parent topic: [Using External USB Devices with Your Product](#)

Related references

[External USB Device Specifications](#)

Related tasks

[Disconnecting a USB Device](#)

Disconnecting a USB Device

After you finish working with a USB device, follow these steps to remove it.

1. If your product is connected to your computer using a USB cable, do one of the following:
 - **Windows:** Open the **My Computer**, **Computer**, **This PC**, or **Windows Explorer** utility. Then right-click the name of your USB device (listed as a removable disk) and select **Eject**.
 - **Mac:** Drag the removable disk icon for your USB device from the desktop into the trash.

Caution: Do not remove a USB device before completing the procedure above or you may lose data from the flash drive.

2. Pull the USB device or cable out of the USB port on the front of the product.

Parent topic: [Using External USB Devices with Your Product](#)

Viewing and Printing from the LCD Screen

See these sections to view and print photos or other files displayed on your product's LCD screen.

[Printing JPEG Photos](#)

[Printing TIFF and PDF Files](#)

Parent topic: [Using External USB Devices with Your Product](#)

Printing JPEG Photos

You can select JPEG photos for printing as you view them on the LCD screen.

1. Press the  home button, if necessary.
2. Select **Memory Device**.
3. Select **JPEG**.

Note: If you have more than 999 JPEG images on your device, the images are divided into groups, and you must first select the group you want to display.

4. Do one of the following to select your photos:
 - In **Tile View**, select the thumbnail images of the photos you want to print.
 - In **Single View**, select the thumbnail image of the photo you want to print, then press the left or right arrow buttons to scroll through and select additional photos, or select **Tile View** to return to the thumbnail image view and select additional photos.
- To select all photos, select the  menu icon and select **Select All Images**.

5. Select **Proceed to Print**.
6. To change the print settings, select **Basic Settings** and select the necessary settings.
7. To adjust the photos (adjustments modify only your printed copies, not the original files), select **Advanced** and make the necessary adjustments.
8. Use the numeric keypad on the control panel or select **Copies** on the LCD screen and use the numeric keypad on the screen to select the number of copies (up to 99).
9. When you are ready to print, select the  **Print** icon.

Note: To cancel printing, select the  cancel button or select **Cancel** on the LCD screen, then select **Cancel** again to confirm.

[Print Setting Options - JPEG Mode](#)

Parent topic: [Viewing and Printing from the LCD Screen](#)

Print Setting Options - JPEG Mode

Select the print settings you want to use when printing a JPEG from a USB device.

Note: Not all options or settings may be available, depending on the file format.

Basic Settings

Print settings	Available options	Description
Paper Setting	Various paper size and type settings	Select the paper source that you want to use.
B&W	—	Prints a color photo in black and white.
Color	—	Prints a color photo in its original colors.

Advanced settings

Print settings	Available options	Description
Layout	1-up	Print one photo per page.
	20-up	Print 20 photos per page.
	Index	Print numbered photo thumbnails with date information.

Print settings	Available options	Description
Fit Frame	On	Automatically crops the photo to fit into the selected photo layout.
	Off	Turns off automatic cropping.
Quality	Standard	Provides good quality for most prints.
	Best	Provides the highest quality for special prints.
Date	Various date formats	Prints the date the photo was taken on the photo in the format you select.
Fix Photo	Various settings	Automatically adjusts the brightness, contrast, and saturation of the photo based on the setting that is selected.
	Enhance Off	Turns off automatic adjustments.
Fix Red-Eye	Off	Automatically fixes the red-eye effect in photos; see Note below.
	On	

Note: **Fix Red-Eye** makes corrections to printouts, not the original photo files. Depending on the type of photo, parts of the image other than the eyes may be corrected.

Parent topic: [Printing JPEG Photos](#)

Printing TIFF and PDF Files

You can select and print TIFF or PDF files from a USB flash drive.

Note: The WF-C5810 does not support printing PDF files from a USB device.

1. Press the  home button, if necessary.
2. Select **Memory Device**.
3. Select **TIFF** or **PDF** (WF-C5890).
You see a list of the available files.
4. Select the file you want to print.
You see information about the file.

5. Do the following as necessary:
 - To print more than one copy, use the numeric keypad on the control panel or select **Copies** on the LCD screen and use the numeric keypad on the screen to select the number of copies (up to 99).
 - To change the print settings, select **Basic Settings** or **Advanced** and select the necessary settings.

6. When you are ready to print, select the  **Print** icon.

Note: To cancel printing, select the  cancel button or select **Cancel** on the LCD screen, then select **Cancel** again to confirm.

[Print Setting Options - TIFF Mode](#)

[Print Setting Options - PDF Mode](#)

Parent topic: [Viewing and Printing from the LCD Screen](#)

Print Setting Options - TIFF Mode

Select the print settings you want to use when printing a TIFF from a USB device.

Note: Not all options or settings may be available, depending on the file format.

Basic Settings

Print settings	Available options	Description
Paper Setting	Various paper size and type settings	Select the paper source that you want to use.
B&W	—	Prints a color photo in black and white.
Color	—	Prints a color photo in its original colors.

Advanced settings

Print settings	Available options	Description
Layout	1-up	Print one photo per page.
	20-up	Print 20 photos per page.
	Index	Print numbered photo thumbnails with date information.

Print settings	Available options	Description
Fit Frame	On	Automatically crops the photo to fit into the selected photo layout.
	Off	Turns off automatic cropping.
Quality	Standard	Provides good quality for most prints.
	Best	Provides the highest quality for special prints.
Print Order	Last Page on Top	Select the printing order for multi-page documents.
	First Page on Top	
Date	Various date formats	Prints the date the photo was taken on the photo in the format you select.

Parent topic: [Printing TIFF and PDF Files](#)

Print Setting Options - PDF Mode

Select the print settings you want to use when printing a PDF from a USB device.

Note: Not all options or settings may be available, depending on the file format.

Basic Settings

Print settings	Available options	Description
Paper Setting	Various paper size and type settings	Select the paper source that you want to use.
B&W	—	Prints a color photo in black and white.
Color	—	Prints a color photo in its original colors.

Advanced settings

Print settings	Available options	Description
2-Sided	Off	Two-sided printing is off.
	On	Two-sided printing is on.
	Binding (Copy)	Select the binding position for the document.

Print settings	Available options	Description
Print Order	Last Page on Top	Select the printing order for multi-page documents.
	First Page on Top	

Parent topic: [Printing TIFF and PDF Files](#)

Transferring Files on a USB Device

You can transfer files to and from a USB device inserted into the USB port on the front of your product.

[Setting Up File Sharing for File Transfers from Your Computer](#)

[Transferring Files from a USB Device to Your Computer](#)

Parent topic: [Using External USB Devices with Your Product](#)

Setting Up File Sharing for File Transfers from Your Computer

Before you transfer files from a computer to a USB device inserted into the USB port on the front of your product, you may need to set up your product's file sharing settings.

Caution: Remove the USB device before you change this setting or you may lose data from the device.

Note: These settings can be locked by an administrator. If you cannot access these settings, contact your administrator for assistance.

1. Press the  home button, if necessary.
2. Select **Settings** > **General Settings** > **Printer Settings** > **Memory Device Interface**.

You see a screen like this:

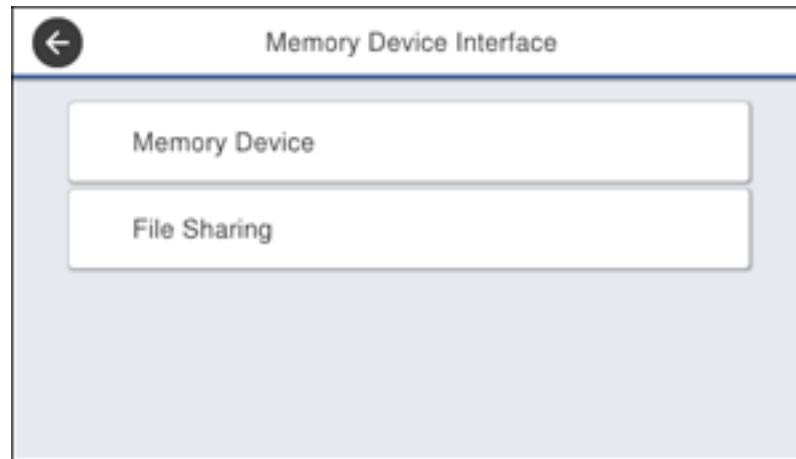

3. Select **Memory Device** and make sure it is set to **Enable**.
4. Select **File Sharing**.
5. Select the way your computer is connected to the product: either **USB** or **Network**.

Parent topic: [Transferring Files on a USB Device](#)

Related tasks

[Disconnecting a USB Device](#)

Transferring Files from a USB Device to Your Computer

You can transfer files to and from a USB device inserted into the USB port on the front of your product and a computer connected to your product.

Note: Do not transfer files to and from a USB device while you are printing from the device.

1. Make sure your product is connected to a computer.
2. Insert a USB device or its USB cable into the USB port on the front of your product.
3. Do one of the following to access your USB device files from your computer:
 - **Windows:** Open the **My Computer**, **Computer**, **This PC**, or **Windows Explorer** utility, then select the removable disk icon.

- **Mac with a USB connection:** Look for the removable disk icon on your desktop, then select it.
 - **Mac with a network connection:** Select the hard drive icon on your desktop or select **Computer** from the **Go** menu, select your product in the **SHARED** section of the sidebar (you may need to widen the sidebar to see the name), and select the **USBSTORAGE** icon.
4. Select the folder that contains your files.
 5. Drag the files you want to transfer to the desired folder on your computer or on your USB device.

Note: Your product's LCD screen does not update to display new information about your USB device after you copy files to it or delete files from it. Remove and insert the USB device to update the information.

Parent topic: [Transferring Files on a USB Device](#)

Related tasks

[Connecting a USB Device](#)

Replacing Ink Supply Units (Ink Packs), Maintenance Boxes, and Cassette Rollers

When ink packs are expended, or the maintenance box and cassette rollers are at the end of their service life, you need to replace them. The maintenance box stores ink that gets flushed from the system during print head cleaning.

Note: Please dispose of your used Epson branded ink packs and maintenance boxes responsibly and in accordance with local requirements. If you would like to return your used ink packs and maintenance boxes to Epson for proper disposal, please go to [epson.com/recycle](https://www.epson.com/recycle) for more information.

[Ink Pack Safety Instructions](#)

[Check Ink and Maintenance Box Status](#)

[Purchase Epson Ink Packs and Maintenance Boxes](#)

[Removing and Installing Ink Packs](#)

[Replacing the Maintenance Box](#)

[Replacing the Paper Feed Rollers](#)

[Resetting the Roller Counter on the LCD Screen](#)

[Printing with Black Ink and Expended Color Ink Packs](#)

[Conserving Low Black Ink with Windows](#)

Ink Pack Safety Instructions

- Keep ink packs out of the reach of children and do not drink the ink.
- Be careful when you handle used ink packs; there may be ink remaining around the ink supply port. If ink gets on your skin, wash it off with soap and water. If it gets in your eyes, flush them immediately with water. If discomfort or vision problems continue after a thorough flushing, see a doctor immediately. If ink gets in your mouth, see a doctor right away.
- Install a new ink pack immediately after removing an expended one. Leaving ink packs uninstalled can dry out the print head and may prevent the product from printing.
- Install all ink packs; otherwise you cannot print.
- If you need to remove an ink pack temporarily, make sure you protect the ink pack from dirt and dust. Store the ink pack in the same environment as the printer. Because the ink supply port is equipped with a valve designed to contain the release of excess ink, there is no need to supply your own covers or plugs.

- Do not remove or tear the label on the ink pack; this can cause leakage.
- Do not remove the transparent seal from the ink supply area. This may cause the ink pack to become unusable.
- Do not touch the green IC chip on the side of the handle. This may prevent normal operation.
- Do not shake ink packs too vigorously; otherwise ink may leak.
- Do not drop or knock the ink pack against hard objects; otherwise ink may leak.
- Use an ink pack before the date printed on its package.
- Do not disassemble an ink pack or a maintenance box. Ink may get in your eyes or on your skin.
- Store ink packs in a cool, dark place.
- Do not store ink packs in high or freezing temperatures.
- After bringing an ink pack inside from a cold storage site, allow it to warm up at room temperature for at least 12 hours before using it.
- Store ink packs with the bottom facing down.
- To help protect your print head, a variable ink safety reserve remains in the ink supply unit when your printer notifies you to replace the ink pack. The yields quoted for you do not include this reserve.
- You cannot use the ink packs supplied with the product as replacement ink packs. They must be used for initial setup.

Parent topic: [Replacing Ink Supply Units \(Ink Packs\), Maintenance Boxes, and Cassette Rollers](#)

Check Ink and Maintenance Box Status

Your product and its software will let you know when ink is low or expended, or when the maintenance box needs to be replaced.

Note: When using the PCL or PostScript (PS3) printer software with the product, you can check ink and maintenance box status by using the product buttons or the utilities included with the standard Epson printer software. To download the standard Epson printer software, visit epson.com/support (U.S.), epson.ca/support (Canada), or latin.epson.com/support (Latin America) and select your product.

[Checking Ink Status on the LCD Screen](#)

[Checking Ink and Maintenance Box Status - Windows](#)

[Checking Ink and Maintenance Box Status - Mac](#)

Parent topic: [Replacing Ink Supply Units \(Ink Packs\), Maintenance Boxes, and Cassette Rollers](#)

Related tasks



[Removing and Installing Ink Packs](#)

[Replacing the Maintenance Box](#)

Checking Ink Status on the LCD Screen

When one of your ink packs is low or expended, you see a message on the LCD screen. Follow the steps on the LCD screen to replace the ink pack.

You can also check the status of the ink packs and maintenance box from the product control panel.

1. Press the  home button, if necessary.
2. Select the  icon.
The ink and maintenance box levels are displayed.

Note: The displayed ink and maintenance box levels are approximate.

Parent topic: [Check Ink and Maintenance Box Status](#)



Related tasks

[Removing and Installing Ink Packs](#)

[Replacing the Maintenance Box](#)

Checking Ink and Maintenance Box Status - Windows

A low ink reminder appears if you try to print when ink is low. You can also check your ink or maintenance box status at any time using a utility on your Windows computer.

1. To check your status, access the Windows Desktop and double-click the  icon for your product in the right side of the Windows taskbar, or click the up arrow and right-click . Then click **Details**.

You see this window:



2. Replace or reinstall the maintenance box or ink pack as indicated on the screen.

Note: If any of the ink packs installed in the product is broken, incompatible with the product model, or improperly installed, Epson Status Monitor will not display an accurate ink status.

Parent topic: [Check Ink and Maintenance Box Status](#)

Related tasks

[Removing and Installing Ink Packs](#)

[Replacing the Maintenance Box](#)

Checking Ink and Maintenance Box Status - Mac

You can check the status of your ink and maintenance box using a utility on your Mac.

1. In the Apple menu or the Dock, select **System Preferences**. Select **Print & Fax**, **Print & Scan**, or **Printers & Scanners**, select your product, and select **Options & Supplies**. Select **Utility** and select **Open Printer Utility**.
2. Select **EPSON Status Monitor**.

You see this window:

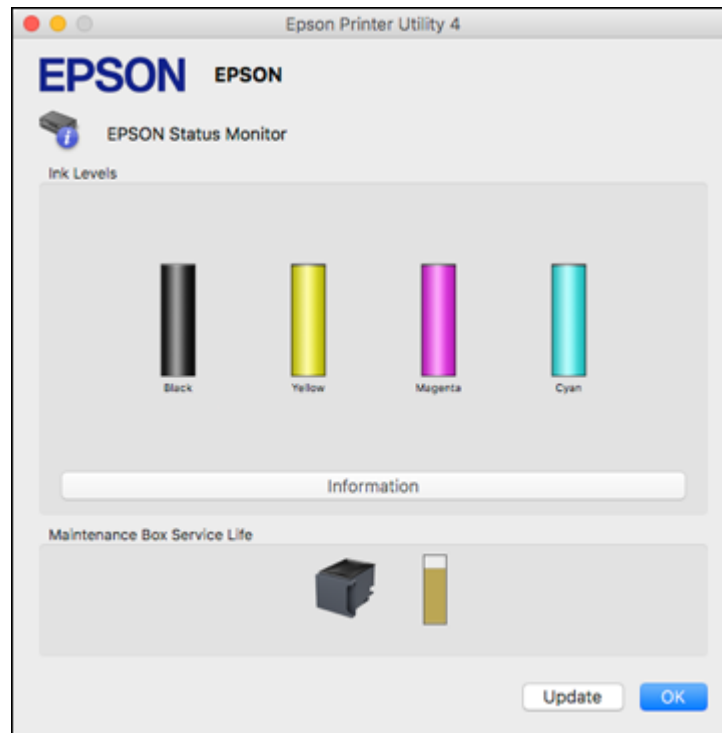

3. Do the following as necessary:
 - You can update the ink and maintenance box status by clicking **Update**.

- Replace or reinstall the maintenance box or an ink pack as indicated on the screen.

Note: If an ink pack installed in the product is broken, incompatible with the product model, or improperly installed, Epson Status Monitor will not display an accurate ink status.

Parent topic: [Check Ink and Maintenance Box Status](#)

Related tasks

[Removing and Installing Ink Packs](#)

[Replacing the Maintenance Box](#)

Purchase Epson Ink Packs and Maintenance Boxes

U.S. and Canada:

You can purchase genuine Epson ink, maintenance boxes, and paper at epson.com (U.S. sales) or epson.ca (Canadian sales). You can also purchase supplies from an Epson authorized reseller. To find the nearest one, call 800-GO-EPSON (800-463-7766) in the U.S. or 800-807-7766 in Canada.

Latin America:

You can purchase genuine Epson ink, maintenance boxes, and paper from an Epson authorized reseller. To find the nearest reseller, visit latin.epson.com or call your nearest Epson sales office.

Note: Your printer is designed to work only with genuine Epson-brand ink packs. Other brands of ink packs and ink supplies are not compatible and, even if described as compatible, may not function properly or at all. Epson periodically provides firmware updates to address issues of security, performance, minor bug fixes and ensure the printer functions as designed. These updates may affect the functionality of third-party ink. Non-Epson branded or altered Epson ink packs that functioned prior to a firmware update may not continue to function.

The included initial ink packs are designed for reliable printer setup and cannot be used as replacement ink packs or resold. After setup, the remaining ink is available for printing. Yields are based on ISO 24711 in default mode, printing continuously. Yields vary due to print images, settings, and temperatures. Printing infrequently or primarily with one color reduces yields. All ink packs must be installed with ink for printing and printer maintenance. For print quality, some ink remains in replaced ink packs.

[Ink Supply Unit \(Ink Pack\) and Maintenance Box Part Numbers](#)

Parent topic: [Replacing Ink Supply Units \(Ink Packs\), Maintenance Boxes, and Cassette Rollers](#)

Ink Supply Unit (Ink Pack) and Maintenance Box Part Numbers

Use these part numbers when you order or purchase new ink packs or a new maintenance box.

U.S. and Canada

Ink color	Part number		
	Standard-capacity	High-capacity	Extra-high capacity
Black	T10S100	T10W100	T10Y100
Cyan	T10S200	T10W200	—
Magenta	T10S300	T10W300	—
Yellow	T10S400	T10W400	—

Maintenance box part number: C9382

Latin America

Ink color	Part number	
	High-capacity	Extra High-capacity
Black	T11A120-AL	T11B120-AL
Cyan	T11A220-AL	—
Magenta	T11A320-AL	—
Yellow	T11A420-AL	—

Maintenance box part number: C9382

Parent topic: [Purchase Epson Ink Packs and Maintenance Boxes](#)

Removing and Installing Ink Packs

If an ink pack is low or expended, a message appears on your product and on your computer screen. Note which ink packs need to be replaced. Make sure you have your replacement ink packs handy before you begin. You must install new ink packs immediately after removing the old ones.

Caution: Make sure you follow all safety precautions when handling ink packs. See the link below for more information.

1. Select **How To**.
2. Follow the on-screen instructions to replace the expended ink packs.

Parent topic: [Replacing Ink Supply Units \(Ink Packs\), Maintenance Boxes, and Cassette Rollers](#)

Related concepts

[Purchase Epson Ink Packs and Maintenance Boxes](#)

Related references

[Ink Pack Safety Instructions](#)

Related tasks

[Printing with Expended Color Ink Packs - Windows](#)

[Printing with Expended Color Ink Packs - Mac](#)

[Conserving Low Black Ink with Windows](#)

Replacing the Maintenance Box

If the maintenance box is full, a message appears on your product's LCD screen. Follow the steps on the LCD screen to replace the maintenance box. Make sure you have a new maintenance box before you begin.

Note: When the maintenance box is full, you cannot print or clean the print head until it is replaced. However, you can perform non-printing functions such as scanning.

Note: If necessary, select the  icon on the LCD, then select **How To > Replace Maintenance Box** and press the **OK** button to view the instructions.

Note: In some print cycles a small amount of surplus ink may be collected in the maintenance box. To prevent ink leakage from the maintenance box, the product is designed to stop printing when the absorbing capacity of the maintenance box has reached its limit. Whether and how often this is required will vary according to the number of pages you print, the type of material you print on and the number of cleaning cycles that the printer performs.

Note the following precautions when replacing the maintenance box:

- Do not remove the maintenance box or its cover except when replacing the maintenance box; otherwise, ink may leak.
- Do not touch the green chip on the side of the maintenance box.
- Do not tilt the maintenance box after removing it or ink may leak.

- Do not touch the openings in the maintenance box or you may get ink on you.
- Do not drop the maintenance box or subject it to strong shocks.
- If you cannot replace the cover, the maintenance box may not be installed correctly. Remove and reinstall the maintenance box.
- Do not store the maintenance box in high or freezing temperatures.
- Do not replace the maintenance box during printing; otherwise, ink may leak.
- Keep the maintenance box out of direct sunlight.

Parent topic: [Replacing Ink Supply Units \(Ink Packs\), Maintenance Boxes, and Cassette Rollers](#)

Related concepts

[Purchase Epson Ink Packs and Maintenance Boxes](#)

Replacing the Paper Feed Rollers

When the paper feed rollers in the paper cassettes need to be replaced, you see a message on the LCD screen. (These are also referred to as "pickup rollers".)

There are different paper feed rollers for the internal paper cassette (Paper Cassette 1) and the optional paper cassettes available for the printer. Make sure you install the correct paper feed rollers for the paper cassette.

- For Paper Cassette 1, use the "Paper Feed Roller for Cassette A" (C12C938261)
- For Paper Cassettes 2 through 4, use the "Paper Feed Roller for Cassette B" (C12C938281)

Refer to the instructions in the paper feed roller packaging when replacing the paper feed rollers. Reset the maintenance roller counter for the paper cassette to keep track of roller usage.

Parent topic: [Replacing Ink Supply Units \(Ink Packs\), Maintenance Boxes, and Cassette Rollers](#)

Related tasks

[Resetting the Roller Counter on the LCD Screen](#)

Resetting the Roller Counter on the LCD Screen

You must reset the roller counter after replacing the cassette rollers to clear the roller replacement message and to keep track of roller usage correctly.

1. Press the  home button, if necessary.
2. Select **Maintenance > Pickup roller information**.
3. Select **Reset Counter**.

4. Select the paper cassette in which you replaced the rollers, if necessary.
5. Select **Yes**.
6. Select **Yes** again to confirm the reset.
7. If you want to feed a sheet of paper to check the roller installation, select **Yes**. (Otherwise, select **No**.)
8. If you selected **Yes**, you can select **Run** to perform a Paper Guide Cleaning cycle, or select **Finish** to exit.
9. Press the  home button to exit.

Parent topic: [Replacing Ink Supply Units \(Ink Packs\), Maintenance Boxes, and Cassette Rollers](#)

Related tasks

[Cleaning the Paper Guide](#)

Printing with Black Ink and Expended Color Ink Packs

When a color ink pack is expended, you can temporarily continue printing from your computer using black ink. Replace the expended color ink pack as soon as possible for future printing.

Note: You cannot print with expended color ink using your product's control panel.

[Printing with Expended Color Ink Packs - Windows](#)

[Printing with Expended Color Ink Packs - Mac](#)

Parent topic: [Replacing Ink Supply Units \(Ink Packs\), Maintenance Boxes, and Cassette Rollers](#)

Printing with Expended Color Ink Packs - Windows

If you see a message during printing telling you that you can temporarily print in black ink with an expended color ink supply unit, you can cancel your print job and select settings to print on plain paper or on an envelope.

Note: To use this feature, Epson Status Monitor must be enabled.

1. Click **Cancel** or **Cancel Print** to cancel your print job.

Note: If the message screen appears on another computer on a network, you may need to cancel the print job using the product control panel.

2. Load plain paper or an envelope in your product.
3. Access the print settings in your print application.
4. Click the **Main** tab.
5. Select **Plain Paper/Bright White Paper** or **Envelope** as the paper type setting.
6. Select the **Black/Grayscale** or **Grayscale** checkbox.
7. Click **OK**.
8. Print your document.
Epson Status Monitor 3 displays a print message.
9. Click **Print in Black** to print your document.

Parent topic: [Printing with Black Ink and Expended Color Ink Packs](#)

Printing with Expended Color Ink Packs - Mac

If printing stops, you can cancel your print job and select settings to temporarily print with only black ink on plain paper or on an envelope.

1. Click the printer icon in the Dock.
2. If you see a message telling you that you can temporarily print with only black ink, click the **Delete** or  icon to cancel your print job. (If an error message is displayed, click **OK**.)

Note: If the message screen appears on another computer on a network, you may need to cancel the print job using the product control panel.

3. In the Apple menu or the Dock, select **System Preferences**.
4. Select **Print & Fax**, **Print & Scan**, or **Printers & Scanners**, select your product, and select **Options & Supplies**.
5. Select **Driver** or **Options**.

You see a screen like this:

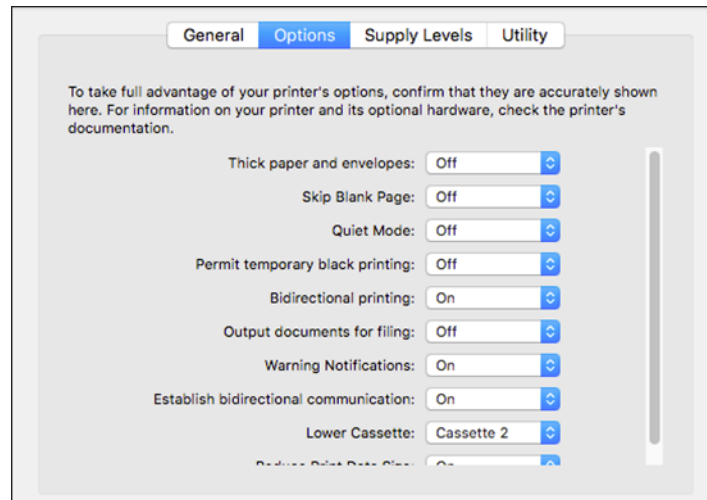

6. Select **On** as the **Permit temporary black printing** setting.
7. Click **OK**.
8. Close the utility window.
9. Load plain paper or an envelope in your product.
10. Access the print settings in your print application.
11. Select **Print Settings** from the pop-up menu.
12. Select **Plain Paper/Bright White Paper** or **Envelope** as the paper type setting.
13. Select the **Grayscale** option.
14. Click **Print** to print your document.

Parent topic: [Printing with Black Ink and Expanded Color Ink Packs](#)

Conserving Low Black Ink with Windows

The following window appears when black ink runs low and there is more color ink.

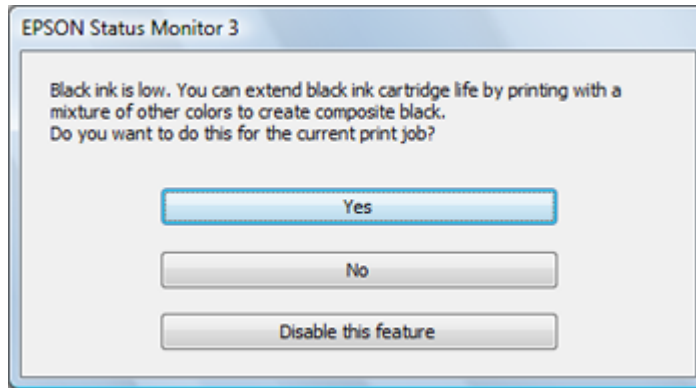

Note: The window appears only when you have selected **Plain Paper/Bright White Paper** as the paper type setting, and depends on other selected print settings. To use this feature, Epson Status Monitor must be enabled.

- Click **Yes** to use a mixture of color inks to create black, or **No** to continue using the remaining black ink for the document you are printing.
- Click **Disable this feature** to continue using the remaining black ink.

Note: If you disable this feature, it remains disabled until you install a new black ink cartridge.

Parent topic: [Replacing Ink Supply Units \(Ink Packs\), Maintenance Boxes, and Cassette Rollers](#)

Adjusting Print Quality

If your print quality declines, you may need to run a utility to clean or align the print head.

[Print Head Maintenance](#)

[Print Head Alignment](#)

[Cleaning the Paper Guide](#)

[Cleaning the Translucent Film](#)

[Checking the Number of Sheets on the LCD Screen](#)

Print Head Maintenance

If your printouts become too light, or you see dark or light bands across them, you may need to clean the print head nozzles. Cleaning uses ink, so clean the nozzles only if print quality declines.

You can check for clogged nozzles before you clean them so you don't clean them unnecessarily.

[Print Head Nozzle Check](#)

[Print Head Cleaning](#)

Parent topic: [Adjusting Print Quality](#)

Print Head Nozzle Check

You can print a nozzle check pattern to check for clogged nozzles.

[Checking the Nozzles Using the Product Control Panel](#)

[Checking the Nozzles Using a Computer Utility](#)

Parent topic: [Print Head Maintenance](#)

Checking the Nozzles Using the Product Control Panel

You can check the print head nozzles using the control panel on your product.

1. Make sure there are no errors on the LCD screen.
2. Load a few sheets of plain paper in the product.
3. Press the  home button, if necessary.
4. Select **Maintenance** > **Print Head Nozzle Check** .
5. Select **Print** and press the **OK** button.

The nozzle pattern prints.

6. Check the printed pattern to see if there are gaps in the lines.

Print head is clean

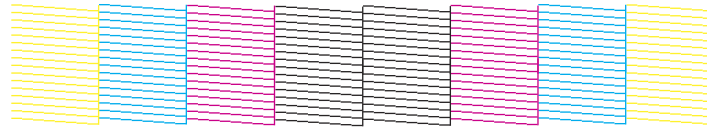

Print head needs cleaning



7. Do one of the following:
 - If there are no gaps, select **O**.
 - If there are gaps or the pattern is faint, select **X**.
8. Follow the instructions on the screen to clean the print head, check the nozzles, and repeat the process as necessary.

Caution: Never turn off the product or open the front cover during a cleaning cycle or you may not be able to print.

If you don't see any improvement after cleaning the print head up to 3 times, wait at least 12 hours without printing. Then try cleaning the print head again. If quality still does not improve, contact Epson support.

Parent topic: [Print Head Nozzle Check](#)

Related tasks



[Cleaning the Print Head Using the Product Control Panel](#)

[Loading Paper in the Paper Cassettes and Rear Paper Tray](#)

Checking the Nozzles Using a Computer Utility

You can check the print head nozzles using a utility on your Windows or Mac computer.

1. Make sure there are no errors on the LCD screen and the output tray is extended.
2. Load a few sheets of plain paper in the product.

3. Do one of the following:
 - **Windows:** Access the Windows Desktop and right-click the  icon for your product in the right side of the Windows taskbar, or click the up arrow and right-click .
 - **Mac:** In the Apple menu or the Dock, select **System Preferences** or **System Settings**. Select **Print & Fax**, **Print & Scan**, or **Printers & Scanners**, select your product, and select **Options & Supplies**. Select **Utility** and select **Open Printer Utility**.
4. Select **Nozzle Check** or **Print Head Nozzle Check**.

You see a window like this:

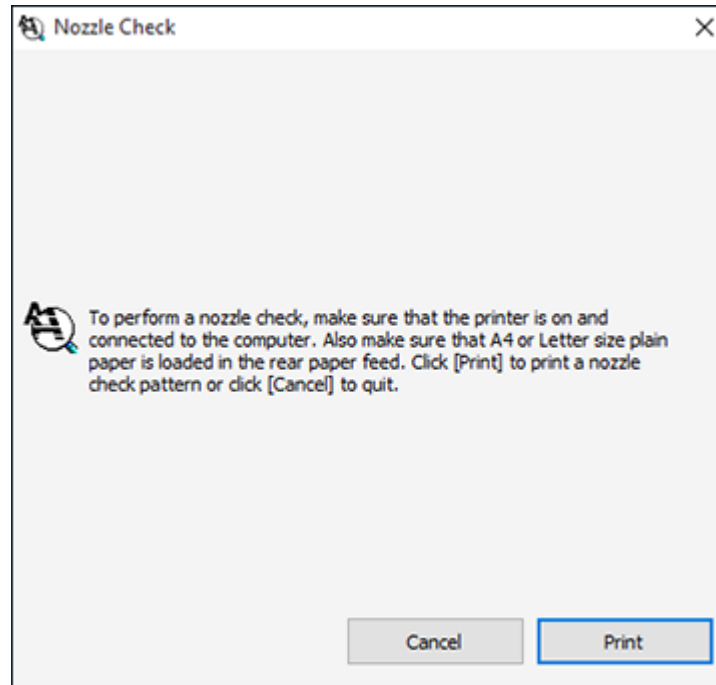

5. Click **Print**.

6. Check the printed pattern to see if there are gaps in the lines.

Print head is clean

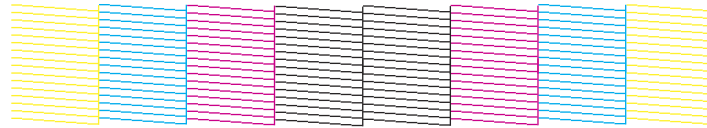

Print head needs cleaning



7. Do one of the following:

- If there are no gaps, click **Finish**.
- If there are gaps or the pattern is faint, clean the print head.

If you don't see any improvement after cleaning the print head up to 3 times, turn the product off and wait at least 12 hours. Then check the print head nozzles and try cleaning the print head again, if necessary. If quality still does not improve, contact Epson.

Parent topic: [Print Head Nozzle Check](#)

Related tasks

[Cleaning the Print Head Using a Computer Utility](#)

[Loading Paper in the Paper Cassettes and Rear Paper Tray](#)

Print Head Cleaning

If print quality has declined and the nozzle check pattern indicates clogged nozzles, you can clean the print head.

Note: You cannot clean the print head if ink is expended, and may not be able to clean it when ink is low. You must replace the ink pack first.

[Cleaning the Print Head Using the Product Control Panel](#)

Cleaning the Print Head Using a Computer Utility

Parent topic: [Print Head Maintenance](#)

Cleaning the Print Head Using the Product Control Panel

You can clean the print head using the control panel on your product.

1. Make sure there are no errors on the LCD screen.
2. Load a few sheets of plain paper in the product.
3. Press the  home button, if necessary.
4. Select **Maintenance > Print Head Cleaning**.
5. Select **Start** to clean the print head.

When the cleaning cycle is finished, a nozzle check pattern is printed.

Caution: Never turn off the product or open the front cover during a cleaning cycle or you may not be able to print.

6. Check the printed pattern to see if there are gaps in the lines.

Print head is clean

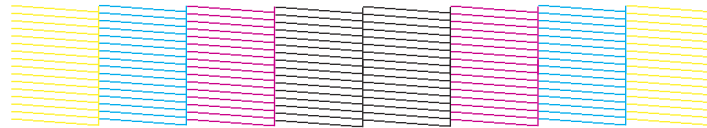

Print head needs cleaning





7. Do one of the following:
 - If there are no gaps, select **O** .
 - If there are gaps or the pattern is faint, select **X** .

If you don't see any improvement after cleaning the print head up to 3 times, wait at least 12 hours without printing. Then try cleaning the print head again. If quality still does not improve, contact Epson.

Parent topic: [Print Head Cleaning](#)

Cleaning the Print Head Using a Computer Utility

You can clean the print head using a utility on your Windows or Mac computer.

1. Make sure there are no errors on the LCD screen.
2. Load a few sheets of plain paper in the product.
3. Do one of the following:
 - **Windows:** Access the Windows Desktop and right-click the  icon for your product in the right side of the Windows taskbar, or click the up arrow and right-click .
 - **Mac:** In the Apple menu or the Dock, select **System Preferences** or **System Settings**. Select **Print & Fax**, **Print & Scan**, or **Printers & Scanners**, select your product, and select **Options & Supplies**. Select **Utility** and select **Open Printer Utility**.
4. Select **Head Cleaning** or **Print Head Cleaning**.

You see a window like this:

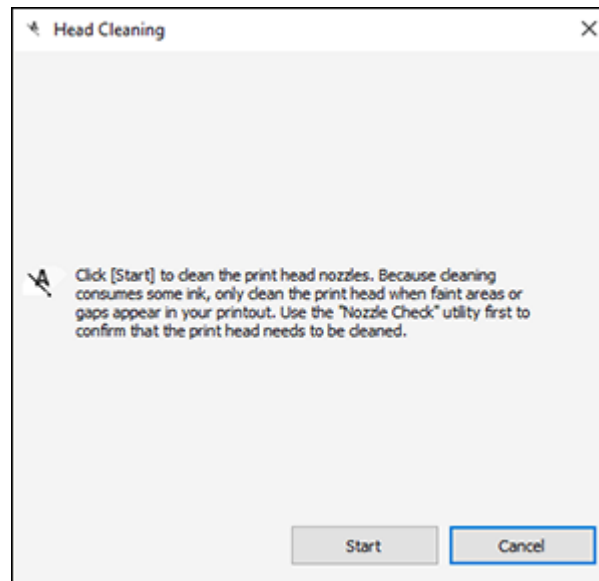

5. Click **Start** to begin the cleaning cycle.

The  power light flashes throughout the cleaning cycle and stays on when the cleaning cycle is finished.

Caution: Never turn off the product or open the front cover during a cleaning cycle or you may not be able to print.

- When the cleaning cycle is finished, you can check to see if the nozzles are clean; click **Print Nozzle Check Pattern** and click **Print**.
- Check the printed pattern to see if there are gaps in the lines.

Print head is clean



Print head needs cleaning



- If there are no gaps, click **Finish**.
- If there are gaps or the pattern is faint, click **Clean** to clean the print head again.

If you don't see any improvement after cleaning the print head up to 3 times, turn off the product and wait at least 12 hours. Then check the print head nozzles and try cleaning the print head again, if necessary. If quality still does not improve, contact Epson.

Parent topic: [Print Head Cleaning](#)

Print Head Alignment

If your printouts become grainy or blurry, you notice misalignment of vertical lines, or you see dark or light horizontal bands, you may need to align the print head.

Note: Banding may also occur if your print head nozzles need cleaning.

[Aligning the Print Head Using the Product Control Panel](#)

[Adjusting the Print Quality Using the Product Control Panel](#)

Parent topic: [Adjusting Print Quality](#)

Aligning the Print Head Using the Product Control Panel

You can align the print head using the control panel on your product.

1. Make sure there are no errors on the LCD screen.
2. Load a few sheets of plain paper in the product.
3. Press the  home button, if necessary.
4. Select **Maintenance > Print Head Alignment**.
5. Select one of the following options:
 - **Ruled Line Alignment** if vertical lines in your printout are misaligned.
 - **Horizontal Alignment** if your printout contains horizontal banding.
6. Follow the on-screen instructions to print an alignment sheet.

Note: Do not cancel printing while you are printing head alignment patterns.

Parent topic: [Print Head Alignment](#)

Related tasks

[Loading Paper in the Paper Cassettes and Rear Paper Tray](#)

Adjusting the Print Quality Using the Product Control Panel

You can adjust the print quality using the control panel on your product.

1. Make sure there are no errors on the LCD screen.
2. Load a few sheets of plain paper in the product.
3. Press the  home button, if necessary.
4. Select **Maintenance > Print Quality Adjustment**.
5. Follow the on-screen instructions to print a nozzle check pattern.
6. Check the printed pattern.

Print head is clean

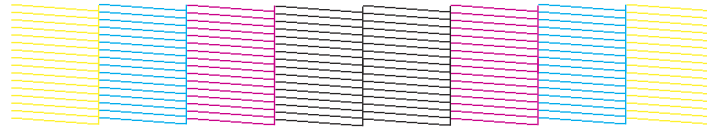

Print head needs cleaning



7. Do one of the following:
 - If there are no gaps, select **O** .
 - If there are gaps or the pattern is faint, select **X**.
8. Follow the on-screen instructions to print an alignment sheet.

Note: Do not cancel printing while you are printing head alignment patterns.

9. Continue following the on-screen instructions to finish the print quality adjustment.

Parent topic: [Print Head Alignment](#)

Related tasks

[Loading Paper in the Paper Cassettes and Rear Paper Tray](#)

Cleaning the Paper Guide

If you see ink on the back of a printout, you can clean the paper guide rollers to remove any excess ink.

1. If printouts are smeared or scuffed, load plain paper in the paper source that you want to clean in this size: Letter (8.5 × 11 inches [216 × 279 mm]) or A4 (8.3 × 11.7 inches [210 × 297 mm]).
2. Press the  home button, if necessary.
3. Select **Maintenance > Paper Guide Cleaning**.
4. Follow the on-screen instructions to clean the paper guide.
5. Repeat these steps as necessary until the paper comes out clean.

Parent topic: [Adjusting Print Quality](#)

Related tasks

[Loading Paper in the Paper Cassettes and Rear Paper Tray](#)

Cleaning the Translucent Film

If the print quality has not improved after aligning the print head and cleaning the paper path, the translucent film inside the product may be smeared with ink.

To clean the printer head path, use the following:

- Several cotton swabs
- ¼ cup (59 ml) water containing 2 to 3 drops of mild dish detergent
- A small flashlight

Caution: Do not use any other liquid to clean the translucent film or you may damage your product.

1. Turn off the product.
2. Unplug the power cable.
3. Disconnect any connected cables.
4. Open the printer cover.

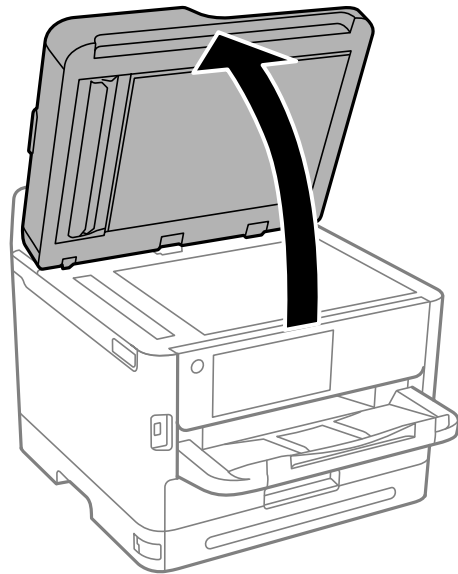

- Using the flashlight, check the translucent film shown here for ink smears.

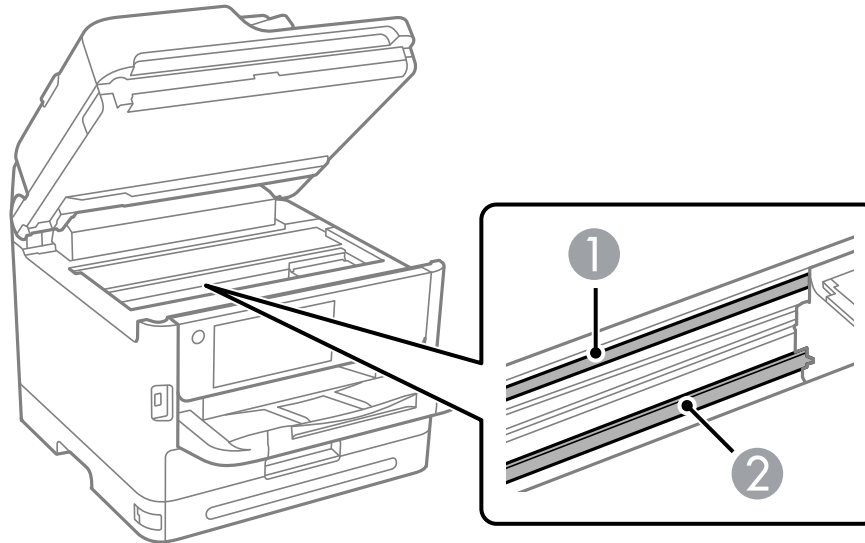

- 1 Translucent film
- 2 Print head rail

Caution: Do not touch the print head rail or you may not be able to print. Do not wipe off the grease on the rail.

- Moisten a cotton swab with the water and detergent mixture and squeeze out any excess moisture, then lightly wipe the ink off the translucent film.

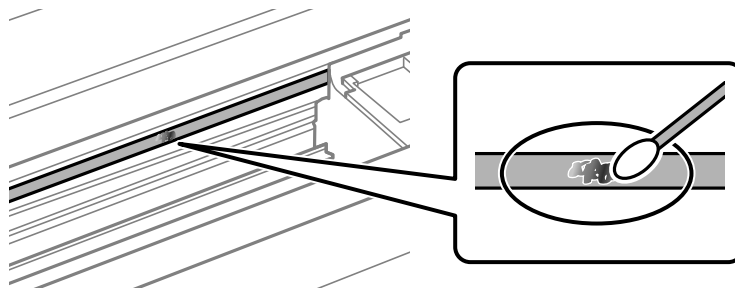

Caution: Do not press too hard on the film or you may dislocate the anchor springs and damage your product.

7. Use a new, dry cotton swab to dry the translucent film.
8. Repeat steps 6 and 7 as necessary to clean all ink smears.
9. When the translucent film is dry and free of any fibers, close the printer cover.
10. Reconnect any disconnected cables, plug in the power cord, and turn on the product.

Parent topic: [Adjusting Print Quality](#)

Checking the Number of Sheets on the LCD Screen

You can view the number of sheets of paper that have fed through the product on the LCD screen.

1. Press the  home button, if necessary.
2. Select **Settings** > **Print Counter**.
3. View the number of prints (**In Total**, **B&W Prints** and **Color Prints**).
4. Select **Print Sheet** and follow the on-screen instructions to print a detailed sheet of the printer's usage history.

Parent topic: [Adjusting Print Quality](#)

Cleaning and Transporting Your Product

See these sections if you need to clean or transport your product.

[Cleaning Your Product](#)

[Cleaning the Scanner Glass](#)

[Cleaning the Automatic Document Feeder](#)

[Transporting Your Product](#)

Cleaning Your Product

To keep your product working at its best, you should clean it several times a year.

Caution: Do not use a hard brush, benzene, alcohol, or paint thinner to clean the product or you may damage it. Do not use oil or other lubricants inside the product or let water get inside it. Close the rear paper feed slot when you are not using it, to keep out dust.

1. Turn off the product.
2. Clean the outer case and control panel with a soft, clean cloth that has been dampened with water. For stubborn dirt, add a small amount of mild detergent to the damp cloth.

Note: Do not touch the parts shown in the following image. This may cause a malfunction.

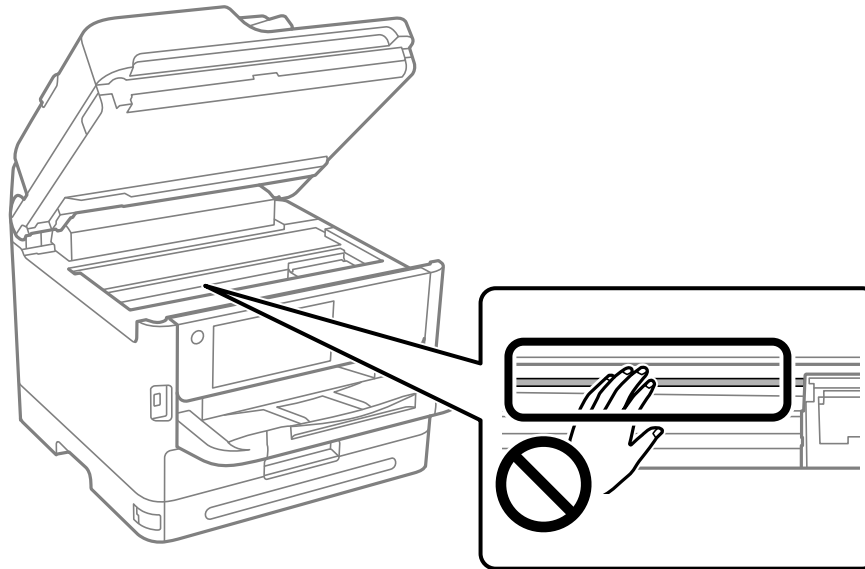

Parent topic: [Cleaning and Transporting Your Product](#)

Cleaning the Scanner Glass

You can clean the scanner glass if your copies or scanned images are smeared.

Caution: Do not use a hard brush, alcohol, or paint thinner to clean the product or you may damage it. Do not use oil or other lubricants inside the product or let water get inside it.

Warning: Do not trap your fingers when opening or closing the document cover or you may be injured.

1. Open the document cover.
2. Use a soft, dry, clean cloth to clean the surface of the scanner glass.

Note: If the glass is stained with grease or dirt, use a small amount of glass cleaner on a soft, dry cloth to remove it. Wipe off all remaining liquid after removing the dirt.

Caution: Do not spray glass cleaner directly on the glass and do not press the glass surface with any force. Be careful not to scratch or damage the glass; this can affect scan quality.

3. Close the document cover.

Parent topic: [Cleaning and Transporting Your Product](#)

Cleaning the Automatic Document Feeder

You can clean the ADF if you see lines or streaks in your copies or scanned images.

Caution: Do not use a hard brush, alcohol, or paint thinner to clean the product or you may damage it. Do not use oil or other lubricants inside the product or let water get inside it.

1. Open the ADF cover.

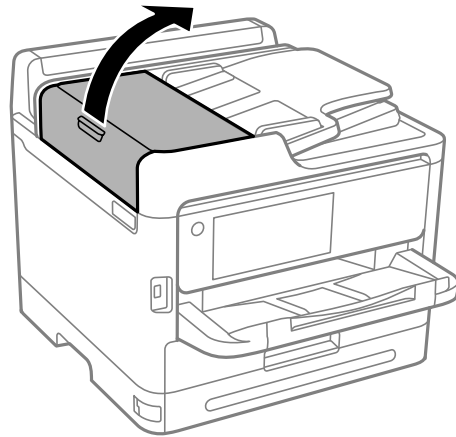

2. Use a soft, lint-free cloth (microfiber is recommended) moistened with a little water to clean the rollers and the interior of the ADF.

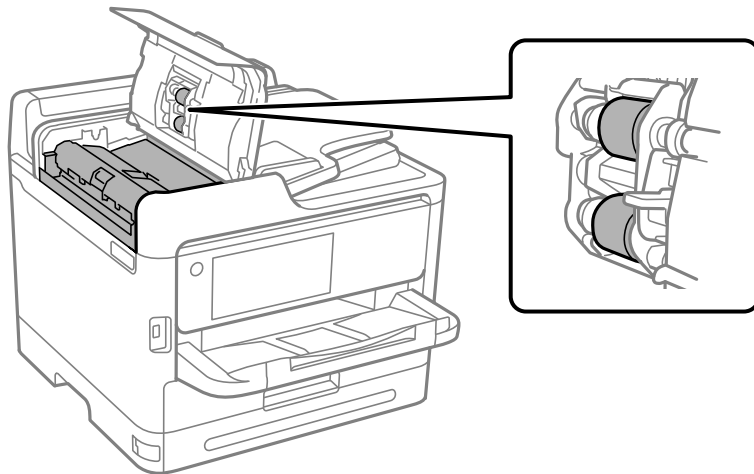

Caution: Do not use a dry cloth; you may damage the ADF rollers. Do not use the ADF until the rollers have dried.

3. Close the ADF cover and open the document cover.

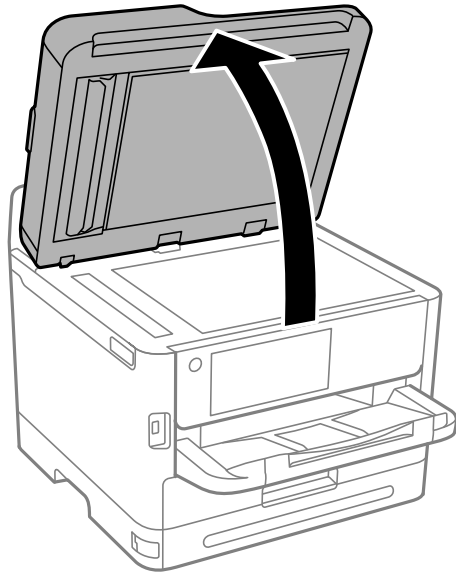

4. Clean the areas indicated in the image:

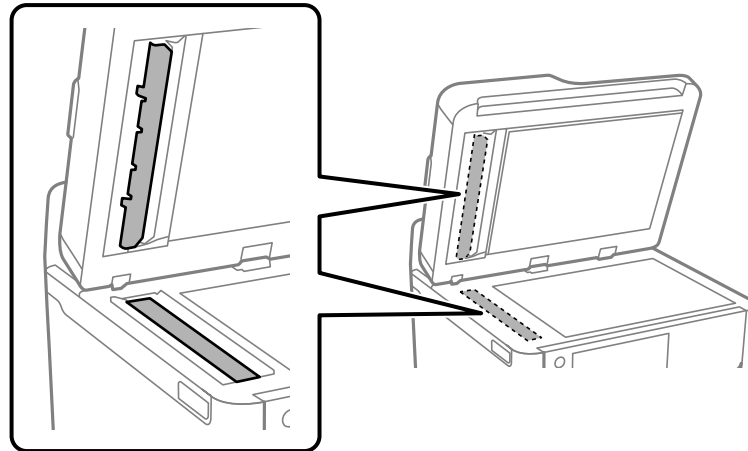

Caution: Do not spray glass cleaner directly on the glass and do not press the glass surface with any force. Be careful not to scratch or damage the glass; this can affect scan quality.

Note: If the glass is stained with grease or dirt, use a small amount of glass cleaner on a soft, dry cloth to remove it. Wipe off all remaining liquid after removing the dirt.

If a black line appears when copying from the ADF, location B in the following image may be dirty. Place the marked copy (A) on the scanner glass and clean the portion of the glass that lines up with the black line. Clean the same location on the underside of the ADF as well.

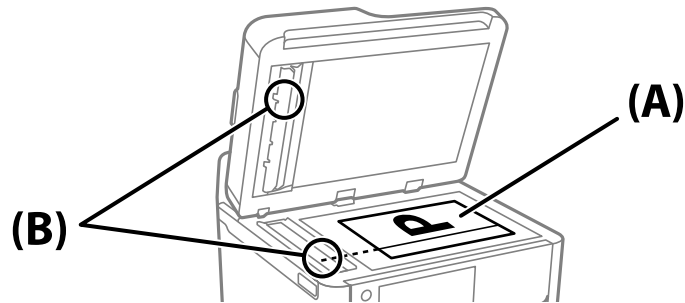

Parent topic: [Cleaning and Transporting Your Product](#)

Transporting Your Product

If you need to store your product or transport it a long distance, prepare it for transportation as described here.

Caution: During transportation and storage, follow these guidelines:

- Because the product is heavy, two or more people should lift and carry it using the hand positions shown here:

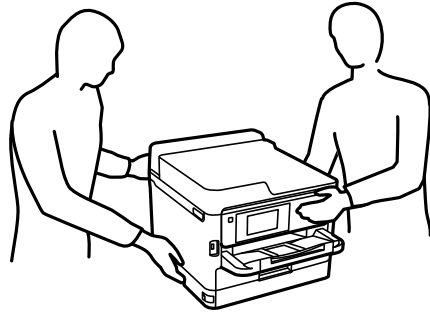

- When carrying the printer, avoid tilting it more than 10° or the printer may fall.
- If additional paper cassettes are installed, uninstall them before lifting the printer.
- Avoid tilting the product, placing it vertically, or turning it upside down; otherwise ink may leak.
- Leave the ink packs installed. Removing the packs can dry out the print head and may prevent the product from printing.

Note: Before storing your product for a long period, replace low, expended, or expired ink to help prevent the print head from drying out. Store your product in a cool, dry place.

1. Turn off the product.
2. Wait for the  power light to turn off, then unplug the power cable.
3. Disconnect any connected cables or devices.
4. Remove all the paper from the product.
5. Lift up the printer cover.
6. Make sure the print head is in the home position on the right.

7. Secure the print head to the case with tape as shown.

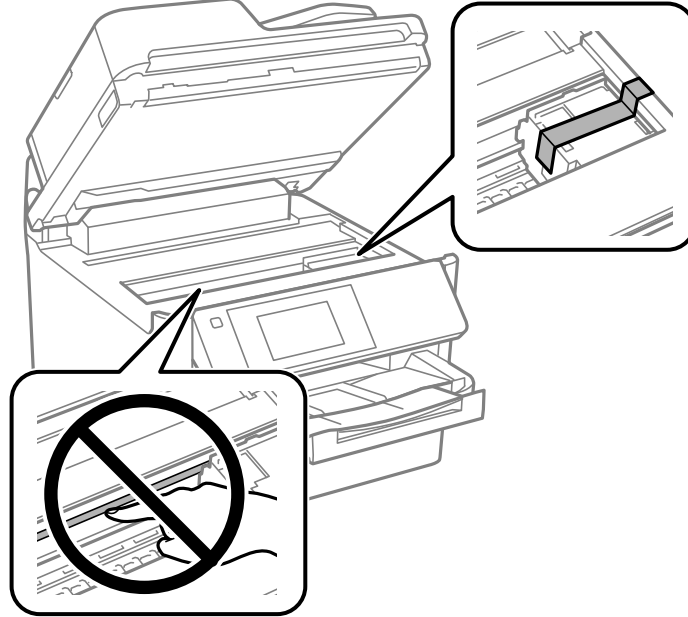

Caution: Do not touch the translucent film inside the product; otherwise, you may damage your product.

8. Lower the printer cover.

9. Unlock and open the front cover.

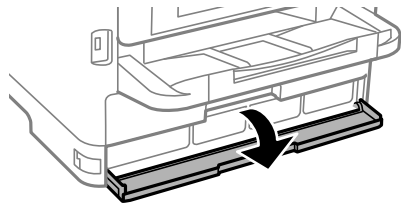
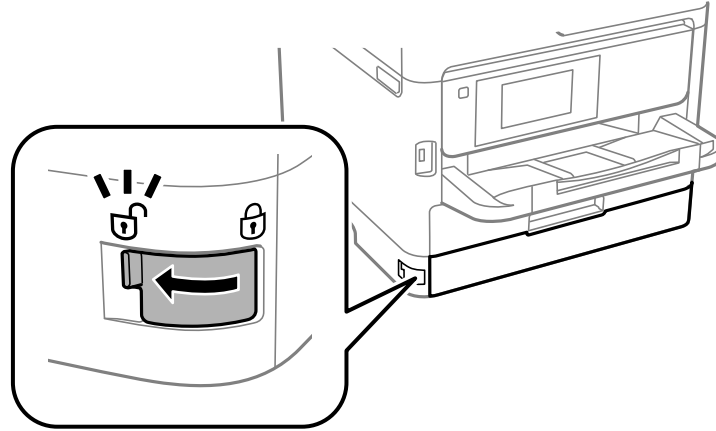

10. If you have the protective material that shipped with your product, use it to secure the ink pack trays.

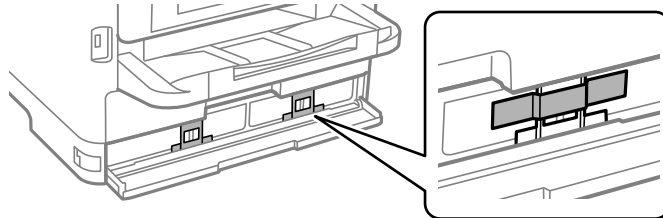

11. When you are finished, close and lock the front cover.

12. Uninstall any optional paper cassettes, if necessary.

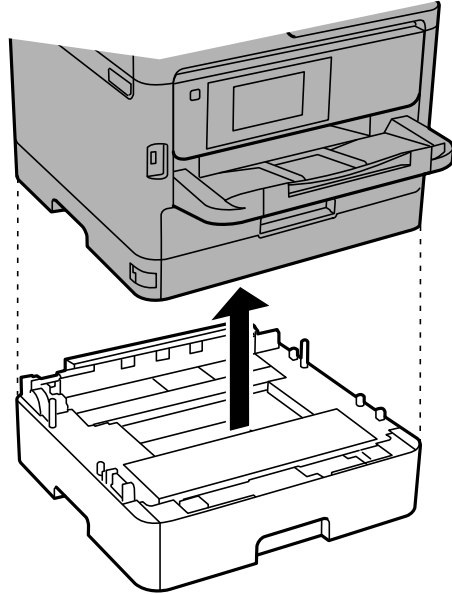

Note: Uninstall the cassettes by performing the installation steps in reverse.

13. Prepare the printer for packing as shown below.

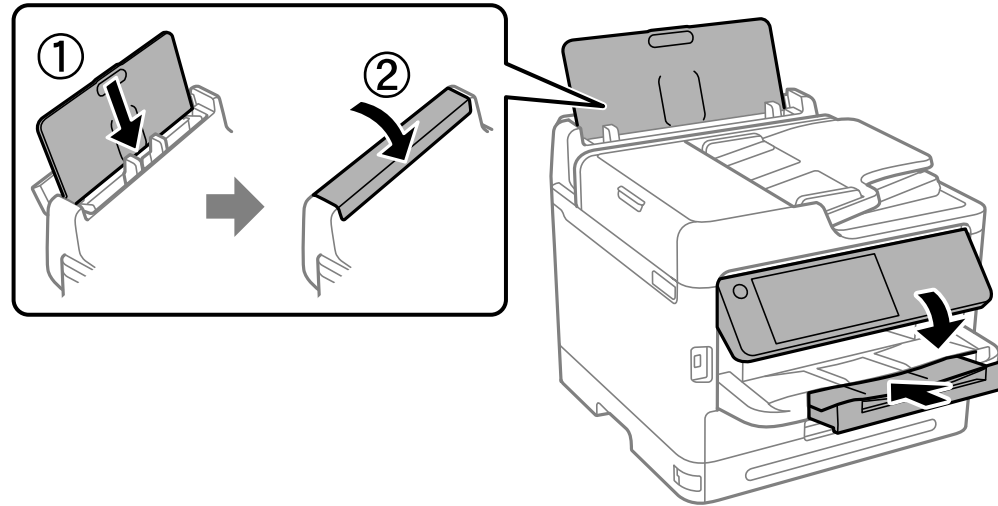

14. Remove the output tray.

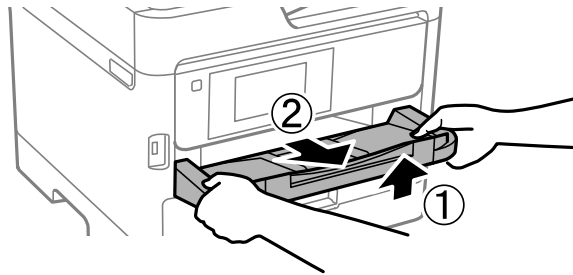

15. Place the product in its original packing materials, if possible, or use equivalent materials with cushioning around the product.

Keep the product level during transportation. If print quality has declined when you print again, clean and align the print head. Make sure you remove the tape securing the print head and the protective material attached to the ink pack trays before using the printer.

Parent topic: [Cleaning and Transporting Your Product](#)

Related tasks

[Installing the Optional Paper Cassette Units](#)

Administering Your Product

Follow the instructions in these sections to configure your product's administrator settings using the Web Config software.

Note: Before you can configure system administration settings, you must connect the product to a network.

[Accessing the Web Config Utility](#)

[Changing the Administrator Password in Web Config](#)

[Configuring Product Settings](#)

[Configuring Security Settings](#)

[Using Your Product on a Secure Network](#)

[Setting Up Universal Print \(Microsoft\)](#)

[Using Epson Device Admin Configuration Software](#)

Accessing the Web Config Utility

You can select your product's network settings and confirm its operating status using a web browser. You do this by accessing your product's built-in Web Config utility from a computer or other device that is connected to the same network as your product.

Note: You can also access the Web Config utility from the product information area in the Epson Smart Panel app.

1. Print a network status sheet.
2. Locate the IP address for your product that is listed on the network status sheet.
3. On a computer or other device connected to the same network as your product, open a web browser.
4. Enter your product's IP address into the address bar.

Note: The printer uses a self-signed certificate when accessing HTTPS. This may cause a warning message when you access Web Config. This does not indicate a problem and can be ignored.

5. On the first visit to the Web Config utility, you will be prompted to set an administrator password. The administrator password is required to access the full capabilities of the Web Config utility.

You see the available Web Config utility options.

Note: The administrator password is required to access the full capabilities of the Web Config utility. The default password is the product's serial number. Check the label on your product to locate the serial number.

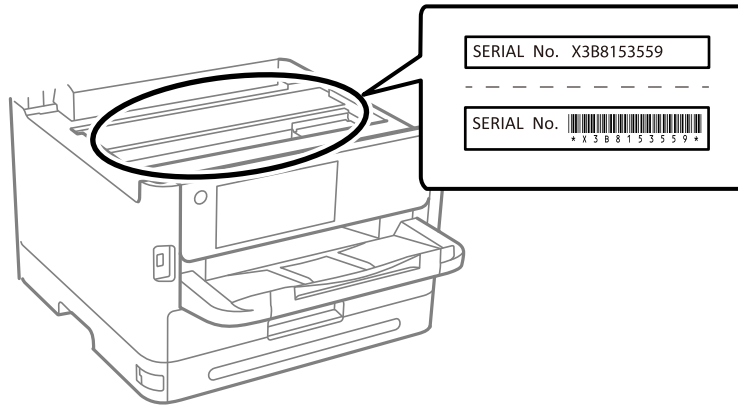

Parent topic: [Administering Your Product](#)

Related tasks

[Changing the Administrator Password in Web Config](#)

[Printing a Network Status Sheet](#)

[Using the Epson Smart Panel Mobile App](#)

Changing the Administrator Password in Web Config

You can set an administrator password using your product's control panel, Web Config, or EpsonNet Config. You use the same administrator password in all cases.

Note: If you forget your administrator password, contact Epson for support.

1. Access Web Config and select the **Product Security** tab.
2. Select **Change Administrator Password**.
3. Enter a user name, if necessary.

4. Do one of the following:
 - If you have set an administrator password before, enter the current password, then enter and confirm the new password in the fields provided.
 - If you have not set an administrator password before, enter a new password and confirm it in the fields provided.
5. Click **OK**.

Note: To restore the administrator password to the default value, select **Restore Default Settings** on the **Change Administrator Password** screen.

Parent topic: [Administering Your Product](#)

Related tasks

[Accessing the Web Config Utility](#)

Configuring Product Settings

Follow the instructions in these sections to configure your product's control panel settings using the Web Config software.

[Checking Status Information](#)

[Managing the Network Connection](#)

[Setting Control Panel Options](#)

[Sending Email Notifications](#)

[Adjusting Power Saving Settings](#)

[Adjusting Control Panel Sounds](#)

[Importing and Exporting Product Settings](#)

[Updating Firmware Using Web Config](#)

[Synchronizing the Date and Time with a Time Server](#)

[Clearing the Internal Memory](#)

[Adjusting the Contact List View Options](#)

[Enabling Periodic Cleaning](#)

[Powering Off or Rebooting the Product Remotely](#)

[Restoring Default Product Settings](#)

Parent topic: [Administering Your Product](#)

Checking Status Information

You can check information about the printer using the Web Config interface.

Note: Depending on the features of your product, not all of the options below may be available. Some options are not available unless you are logged in to the Web Config interface.

1. Enter the IP address of the printer to access Web Config and log in as an administrator, if necessary.
2. Select the **Status** tab and choose one of the following options:
 - Select **Product Status** to view information such as ink level and maintenance box status.
 - Select **Network Status** to view network information such as the IP address and network connection status.
 - Select **Usage Status** to view information about the number of prints and historical information about the product.
 - Select **Hardware Status** to view information about the product functions.
 - Select **Job History** to view information about the jobs completed on the product.
 - Select **Panel Snapshot** to view a image of the current LCD screen.

Parent topic: [Configuring Product Settings](#)

Related tasks

[Accessing the Web Config Utility](#)

Managing the Network Connection

You can check or update the network information for your product using the Web Config interface.

1. Enter the IP address of the product in a web browser and log in as an administrator.
2. Select the **Network** tab, then select **Basic**.
3. Check or update the settings as necessary.
4. Select **Next** to see a summary of the network settings.
5. Select **OK** to accept the changes.

Note: The network connection will be temporarily interrupted to enable the new settings.

6. Select the other network options as necessary:
 - **Wi-Fi:** Displays the current wireless network connection information. Select **Setup** to run the wireless setup again or **Disable Wi-Fi** to turn off Wi-Fi.
 - **Wired LAN:** Displays the current settings for the wired connection. Change the settings as necessary and then select **Next** to view the changes. Confirm the information and select **OK** to apply the changes.
 - **Wi-Fi Direct:** Displays the current settings for the Wi-Fi Direct network. Adjust the settings as necessary and select **Next** to view the changes. Confirm the information and select **OK** to apply the changes.

[Network Settings](#)

Parent topic: [Configuring Product Settings](#)

Related tasks

[Accessing the Web Config Utility](#)

Network Settings

The following network settings are available under the **Network** tab in the Web Config interface.

Basic

Setting	Description
Device Name	Displays the Device Name. You can enter a new name to change the name of the device.
Location	Displays a user-entered location for the printer
Obtain IP Address	Sets the IP Address; if set to Manual , enter the information in the appropriate fields
Set using BOOTP	Enables IP addressing using BOOTP
Set using Automatic Private IP Addressing (APIPA)	Enables IP addressing using APIPA
IP Address	Displays the IP address. If you are manually entering the IP address, enter it in the format xxx.xxx.xxx.xxx (where xxx is a number between 0 and 255). Make sure the address is unique and does not conflict with any other device on your network.

Setting	Description
Subnet Mask	Displays the subnet mask. If you are manually entering the subnet mask, enter it in the format xxx.xxx.xxx.xxx (where xxx is a number between 0 and 255).
Default Gateway	Displays the default gateway address. If you are manually setting the default gateway, enter it in the format xxx.xxx.xxx.xxx (where xxx is a number between 0 and 255).
DNS Server Setting	Selects the DNS server setting. If the Obtain IP Address setting is set to Manual , this setting is also set to Manual .
Primary DNS Server	Enter the address of the primary DNS server in the format xxx.xxx.xxx.xxx (where xxx is a number between 0 and 255).
Secondary DNS Server	Enter the address of the secondary DNS server in the format xxx.xxx.xxx.xxx (where xxx is a number between 0 and 255).
DNS Host Name Setting	Sets the DNS Host Name selection method
DNS Host Name	Displays the current DNS Host Name.
DNS Domain Name Setting	Sets the DNS Domain Name selection method
DNS Domain Name	Specifies the DNS domain name. The name must conform to the following format: <ul style="list-style-type: none"> • Enter between 2 and 249 characters using only the characters "A-Z", "a-z", "0-9", hyphen "-", and a period "." • The first character cannot be a "0-9", hyphen "-", or a period "." • The last character cannot be a hyphen "-" or a period "." • Each label in the domain name must be between 1 and 63 characters and separated by a period. • The total number of characters in the host and domain name must not exceed 251.
Register the network interface address to DNS	Allows you to register the host and domain names through a DHCP server that supports Dynamic DNS
Proxy Server Setting	Enables the use of a proxy server
Proxy Server	Specifies the name of the proxy server in either IPv4 or FQDN format

Setting	Description
Proxy Server Port Number	Specifies the port number for the proxy server (between 1 and 65535)
Proxy Server User Name	Specifies the user name for the proxy server (0-255 ASCII characters [0x20-0x7E])
Proxy Server Password	Specifies the password for the proxy server (0-255 ASCII characters [0x20-0x7E])
IPv6 Setting	Enables the use of IPv6 addressing
IPv6 Privacy Extension	Enables the use of private IPv6 addresses
IPv6 DHCP Server Setting	Enables the use of a IPv6 DHCP server
IPv6 Address	<p>Specifies the IPv6 address. The address must conform to the following format:</p> <ul style="list-style-type: none"> • xxxx: xxxx: xxxx: xxxx: xxxx: xxxx: xxxx / prefix • xxxx is a hexadecimal number from 1 to 4 digits, and the prefix is a decimal number from 1 to 128. • If there are consecutive blocks where xxxx is all zeros, it can be omitted as ::. (Only one block can be omitted).
IPv6 Address Default Gateway	<p>Specifies the IPv6 address of the default gateway. The address must conform to the following format:</p> <ul style="list-style-type: none"> • xxxx: xxxx: xxxx: xxxx: xxxx: xxxx: xxxx: xxxx • xxxx is a hexadecimal number from 1 to 4 digits • If there are consecutive blocks where xxxx is all zeros, it can be omitted as ::. (Only one block can be omitted).
IPv6 Link-Local Address	Displays the valid IPv6 Link-Local Address
IPv6 Stateful Address	Displays the valid IPv6 Stateful Address
IPv6 Stateless Address 1	Displays the valid IPv6 Stateless Address 1
IPv6 Stateless Address 2	Displays the valid IPv6 Stateless Address 2
IPv6 Stateless Address 3	Displays the valid IPv6 Stateless Address 3

Setting	Description
IPv6 Primary DNS Server	Specifies the address for the IPv6 primary DNS server. The address must conform to the following format: <ul style="list-style-type: none"> • xxxx: xxxx: xxxx: xxxx: xxxx: xxxx: xxxx: xxxx • xxxx is a hexadecimal number from 1 to 4 digits • If there are consecutive blocks where xxxx is all zeros, it can be omitted as ::. (Only one block can be omitted)
IPv6 Secondary DNS Server	Specifies the address for the IPv6 secondary DNS server. The address must conform to the following format: <ul style="list-style-type: none"> • xxxx: xxxx: xxxx: xxxx: xxxx: xxxx: xxxx: xxxx • xxxx is a hexadecimal number from 1 to 4 digits • If there are consecutive blocks where xxxx is all zeros, it can be omitted as ::. (Only one block can be omitted)
IEEE802.11k/v	Enables the use of IEEE802.11k/v network environments
IEEE802.11r	Enables the use of IEEE802.11r network environments

Wired LAN

Setting	Description
Link Speed and Duplex	Selects the communication mode for the wired connection
IEEE 802.3az	Enables the use of IEEE 802.3az network environments

Wi-Fi Direct

Setting	Description
Wi-Fi Direct	Enables the product's Wi-Fi Direct network
SSID	You can change part of the SSID for the product.
Password	Specifies the password for the Wi-Fi Direct network. Note: Changing the password will disconnect any devices currently connected to the network.

Setting	Description
Frequency Range	Selects the frequency range used by the Wi-Fi Direct network.
IP Address	Specifies the IP address for the Wi-Fi Direct network. If set to Manual , enter the IP address in the provided fields.

Parent topic: [Managing the Network Connection](#)

Related tasks

[Modifying the Wi-Fi Direct Network Name or Password](#)

Setting Control Panel Options

You can configure the behavior of the product control panel using the Web Config interface or the menus on the control panel.

1. Enter the IP address of the product in a web browser and log into Web Config as an administrator.
2. Select the **Device Management** tab and set the following items as necessary:
 - **Language:** Sets the display language
 - **Panel Lock:** Requires an administrator login to access some menu settings on the control panel. The administrator password must be set to enable this feature.
 - **Operation Timeout:** Cancels operations and automatically logs out users after a selected time period. You can select a time period between 10 seconds and 240 minutes.

Parent topic: [Configuring Product Settings](#)

Related tasks

[Accessing the Web Config Utility](#)

Sending Email Notifications

You can set up email notifications that will be sent when an event occurs on the product. You can register up to five destinations.

Note: You must have configured a mail server before setting up notifications.

1. Enter the IP address of the product in a web browser and log into Web Config as an administrator.
2. Select the **Device Management** tab, then select **Email Notification**.

3. Set the contents of the email subject line by selecting items from the drop-down menus.

Note: You cannot select the same item in both menus. If the Location setting is longer than 32 bytes, it will be truncated in the Subject line.

4. Enter up to five email addresses to receive the notification emails, and select the language of the notification email.
5. In the Notification Settings area, select one or more email addresses to receive a notification for each event.
6. Click **OK** to apply the settings.

Note: To clear the email notification settings, select **Restore Default Settings**. This clears all email notification settings, not just the changes made in the current session.

Parent topic: [Configuring Product Settings](#)

Related tasks

[Accessing the Web Config Utility](#)

Adjusting Power Saving Settings

The product can automatically enter sleep mode or turn off after it has not been used for a while. You can set the delay before the product enters sleep mode or turns off.

1. Log in to the Web Config interface as an administrator.
2. Select the **Device Management** tab, then select the **Power Saving** setting.
3. Set **Sleep Mode** to the number of minutes before the product enters a low-power mode.
4. Select **Power Off Timer** to set the amount to time of inactivity before the product turns off.

Note: If you are using the fax feature, select **None**.

Note: You can also configure the power saving settings using the control panel by selecting **Settings > General Settings > Basic Settings** and selecting the feature you want to change.

Parent topic: [Configuring Product Settings](#)

Related tasks

[Accessing the Web Config Utility](#)

[Changing the Sleep Timer Settings](#)

[Changing the Power Off Timer Settings](#)

Adjusting Control Panel Sounds

You can adjust the sound level heard when you press buttons on the control panel.

1. Log in to the Web Config interface as an administrator.
2. Select the **Device Management** tab, then select the **Sounds** setting.
3. Select volume and sound settings as necessary for **Normal Mode** and **Quiet Mode**. You can also create different sound settings for fax operations.

Note: You can also configure the sound settings using the control panel by selecting **Settings > General Settings > Basic Settings > Sounds**.

Parent topic: [Configuring Product Settings](#)

Related tasks

[Accessing the Web Config Utility](#)

Importing and Exporting Product Settings

Follow the instructions in these sections to import and export your product's settings using the Web Config software.

[Exporting Settings Using Web Config](#)

[Importing Settings Using Web Config](#)

Parent topic: [Configuring Product Settings](#)

Exporting Settings Using Web Config

You can export your product's settings and optionally encrypt the settings file with a password.

1. Access Web Config and select **Export and Import Setting Value**.
2. Select **Export**.
3. Select the settings you want to export.

Note: If you select a parent category, the child categories are also selected. By default, items that are unique on the network, such as IP address, cannot be selected. If you want to export these items, select **Enable to select the individual settings of device**. It is recommended that you export only unique items when replacing a product on the network, otherwise you may encounter conflicts on the network.

4. Enter an encryption password, if desired.
5. Click **Export** and save the file.

Parent topic: [Importing and Exporting Product Settings](#)

Related tasks

[Accessing the Web Config Utility](#)

Importing Settings Using Web Config

You can import settings to your product that you have exported previously. If encryption was used when the settings were exported, obtain the necessary password before you import.

1. Access Web Config and select **Export and Import Setting Value**.
2. Select **Import**.
3. Click **Browse** and select the exported settings file.
4. If necessary, enter the decryption password.
5. Click **Next**.
6. Select the settings to import and click **Next**.
7. Click **OK**.

The selected settings are imported to the product.

Parent topic: [Importing and Exporting Product Settings](#)

Related tasks

[Accessing the Web Config Utility](#)

Updating Firmware Using Web Config

If your product is connected to the Internet, you can update the product firmware using Web Config.

1. Access Web Config and select **Device Management > Firmware Update**.
2. Click **Start** to check for the latest firmware.
3. If there is a firmware update, click **Start** to begin the update.

Note: Make sure the product is not in use and clear any errors on the LCD screen before starting the update. You can also schedule a firmware update by selecting **Automatic Firmware Update** from the menu.

Parent topic: [Configuring Product Settings](#)

Related tasks

[Accessing the Web Config Utility](#)

Synchronizing the Date and Time with a Time Server

You can synchronize the product with an NTP time server to set the date and time on the product.

Note: If you are using a CA certificate or Kerberos authentication, it is recommended to use a time server to set the date and time.

1. Log in to the Web Config interface as an administrator.
2. Select the **Device Management** tab, then select the **Date and Time > Time Server** setting.
3. Set **Use Time Server** to **Use**.
4. Enter the time server address in **Time Server Address**. You can use the IPv4, IPv6, or FQDN format for the address. You are limited to 252 characters.
5. Enter an update interval (up to 10080 minutes) in **Update Interval (min)**.
6. Click **OK** to update the settings.

Parent topic: [Configuring Product Settings](#)

Related tasks

[Accessing the Web Config Utility](#)

Clearing the Internal Memory

You can delete the contents of the product's internal memory, such as password-protected print jobs and downloaded PCL fonts and macros using the Web Config interface. You cannot select individual items to delete.

1. Log in to the Web Config interface as an administrator.
2. Select the **Device Management** tab, then select the **Clear Internal Memory Data** setting.
3. Select **Delete** and confirm your selection.

Parent topic: [Configuring Product Settings](#)

Related tasks

[Accessing the Web Config Utility](#)

Adjusting the Contact List View Options

You can adjust the way contacts are listed on the product's LCD screen. You can also configure the way searches are performed when searching the contact list.

1. Log in to the Web Config interface as an administrator.
2. Select the **Device Management** tab, then select the **Contacts Manager** setting.
3. Select either **Tile View** or **List View** to control how the contacts are displayed on the product's LCD screen.
4. Select an search option from the **Search Options** drop-down list.
5. Select **OK** to apply your changes.

Parent topic: [Configuring Product Settings](#)

Related tasks

[Accessing the Web Config Utility](#)

Enabling Periodic Cleaning

You can set a schedule to clean the print head using the Web Config interface.

1. Log in to the Web Config interface as an administrator.
2. Select the **Device Management** tab, then select the **Periodic Cleaning** setting.
3. Select one of the following options:
 - To clean the print head after a print job, select **After Printing**.
 - To run a cleaning cycle at a specific time, select **Schedule** and choose a time from the drop-down list.

Parent topic: [Configuring Product Settings](#)

Related concepts

[Print Head Cleaning](#)

Related tasks

[Accessing the Web Config Utility](#)

Powering Off or Rebooting the Product Remotely

You can power off or reboot the product using the Web Config interface.

1. Log in to the Web Config interface as an administrator.

2. Select the **Device Management** tab, then select the **Power** setting.
3. Select a power option from the drop down menu and select **Execute**.

Note: After turning off the product, you cannot access Web Config until the product is turned on again.

Parent topic: [Configuring Product Settings](#)

Related tasks

[Accessing the Web Config Utility](#)

Restoring Default Product Settings

You can reset the product to the default settings using the Web Config interface.

1. Log in to the Web Config interface as an administrator.
2. Select the **Device Management** tab, then select the **Restore Default Settings** setting.
3. Select an option from the drop-down list. You can either restore network settings or all data and settings.
4. Select **Execute** and confirm your selection to restore the product settings

Parent topic: [Configuring Product Settings](#)

Related tasks

[Accessing the Web Config Utility](#)

Configuring Security Settings

Follow the instructions in these sections to configure internal security features for your product using the Web Config software.

[Connecting an Authentication Device](#)

[Restricting Features Available for Users](#)

[Disabling the External Interface](#)

[Setting Up Password Encryption](#)

[Working with Audit Logs](#)

[Restricting PDL File Operations](#)

[Enabling Program Verification on Start Up](#)

[Restricting Domain Access](#)

Parent topic: [Administering Your Product](#)

Connecting an Authentication Device

You can connect an authentication device such as an IC card reader using a USB cable, and check the functionality of the reader using the Web Config interface.

1. Remove the sticker covering the service port on the rear of the product.

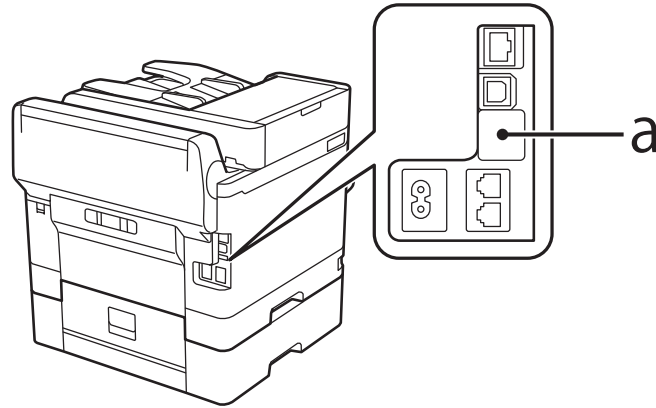

2. Connect the card reader's USB cable to the service port on the product.

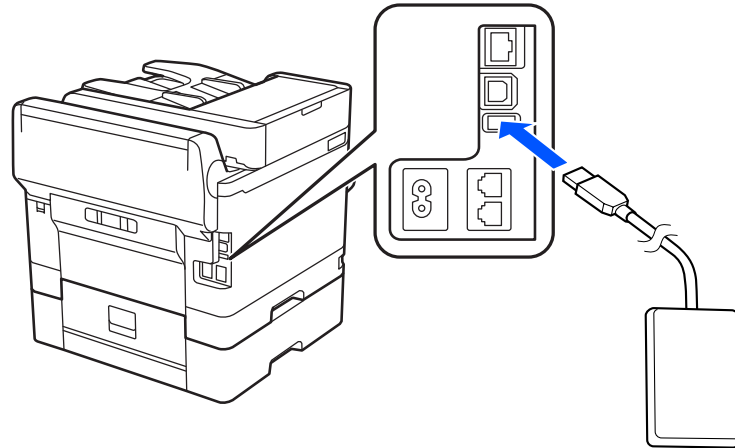

3. Access Web Config and log in using the administrator name and password.

Note: You can also check the card reader status on the product control panel by selecting **Settings > Authentication Device Status**.

4. Select **Device Management > Card Reader**.
5. Set the card reader parameters as necessary.
6. Select **Check** to verify the connection status of the authentication device.

Note: To confirm that the authentication device can recognize an authentication card, hold the card over the reader while you select **Check**.

7. Click **Next**.
8. Click **OK** to confirm the settings.

Parent topic: [Configuring Security Settings](#)

Restricting Features Available for Users

Follow the instructions in these sections to restrict users from using certain product features and create an administrator password to lock the restrictions using the Web Config software.

[User Feature Restriction](#)

[Configuring User Feature Restrictions](#)

Parent topic: [Configuring Security Settings](#)

User Feature Restriction

You can restrict available product features for individual users, with different features available to each user. This requires users to log into the product control panel with their user name and password before they can use control panel features.

With Windows, you can also restrict printing and scanning from the product software. This requires users to log into the printing or scanning software, and allows the software to authenticate the users before printing or scanning proceeds. For instructions on setting up software restrictions, see the help utility in the printing or scanning software.

Parent topic: [Restricting Features Available for Users](#)

Configuring User Feature Restrictions

You can create up to 10 user accounts and restrict access to control panel features separately for each one.

Note: If you are using an authentication system, it uses the number one user account. If you create other user accounts, use the number two to number 10 user accounts.

1. Access Web Config and select the **Product Security** tab.

2. Select the **Enables Access Control** checkbox.
3. If you have configured the product for an LDAP server or IEEE 802.1x network, you can deselect the **Allows printing and scanning without authentication information from a computer** checkbox to prevent the product from receiving jobs sent from these sources:
 - The default operating system driver
 - A PCL or PostScript printer driver
 - Web services such as Epson Connect
 - Smartphones and other mobile devices
4. Click **OK**.
5. Select **User Settings**.
6. Click **Add**.
7. Enter a name for a user in the User Name field following the guidelines on the screen. Use ASCII (0x20-0x7E) characters.
8. Enter a password for the user in the Password field following the guidelines on the screen.

Note: If you need to reset a password, leave the password field blank.

9. Select the checkbox for each function you want the user to be able to perform, and deselect the checkbox for each function you want to restrict access to.
10. Click **Apply**.

Note: When you edit a completed user account, you see a **Delete** option. Click it to delete a user, if necessary.

Note: You can import and export a list of user features using EpsonNet Config. See the help utility in the software for instructions.

Parent topic: [Restricting Features Available for Users](#)

Disabling the External Interface

You can restrict the ability to connect from a computer using a USB connection or accessing a connected USB device or memory card.

Note: Depending on your product features, not all of the options listed below may be available.

1. Access Web Config and select **Product Security > External Interface**.
2. Select **Memory Device** and do one of the following:
 - Select **Disable** to prevent access to a USB device or memory card.
 - Select **Enable** to allow access to a USB device or memory card.
3. Select **PC Connection via USB** and do one of the following:
 - Select **Disable** to prevent a computer from connecting to the product over a USB connection
 - Select **Enable** to allow a computer to connect to the product over a USB connection
4. Click **OK** to save your setting.

Parent topic: [Configuring Security Settings](#)

Related topics

[Using External USB Devices with Your Product](#)

Setting Up Password Encryption

You can set up password encryption to protect confidential information stored in the product.

1. Log in to the Web Config interface as an administrator.
2. Select the **Product Security** tab and select **Password Encryption**.
3. Select **On** and select **OK**.
A message appears about restarting the product. Select **OK**.
4. Turn the product off and then on again to apply the password encryption setting.

Note: The product may take longer than usual to turn on. This is normal.

Parent topic: [Configuring Security Settings](#)

Working with Audit Logs

You can enable the Audit Log feature or export audit log data using the Web Config interface. Audit logs can be used to track security issues or identify improper usage.

1. Log in to the Web Config interface as an administrator.
2. Select the **Product Security** tab, then select the **Audit Log** setting.
3. Select **ON** to enable the audit log feature.
4. Select **Export** to export the audit log data to a CSV file, or select **Delete** to delete all audit logs.

Parent topic: [Configuring Security Settings](#)

Restricting PDL File Operations

You can protect files from unauthorized PDL operations using the Web Config interface.

1. Log in to the Web Config interface as an administrator.
2. Select the **Product Security** tab, then select the **File Operations from PDL** setting.
3. Select **Allowed** or **Not Allowed** to enable or disable PDL file operations and select **OK** to apply your setting.

Parent topic: [Configuring Security Settings](#)

Enabling Program Verification on Start Up

You can check whether unauthorized third parties have tampered with the program when the product starts up using the Web Config interface.

1. Log in to the Web Config interface as an administrator.
2. Select the **Product Security** tab, then select the **Program Verification on Start Up** setting.
3. Select **ON** and then select **OK** to apply the setting.

Parent topic: [Configuring Security Settings](#)

Restricting Domain Access

You can set up restrictions on the email domains that can be used for email notifications using the Web Config interface.

1. Log in to the Web Config interface as an administrator.
2. Select the **Product Security** tab, then select the **Domain Restrictions** setting.
3. Select a restriction method for the **Restriction Rule** setting. Select **Allow Sending** to limit sending emails to the listed domains or select **Deny Sending** to prevent emails from being sent to the listed domains.
4. Add the necessary domains to the list by entering them in the **Domain Name** field and selecting **Add**.

The domain is added to the list. To delete domain, select the checkbox next to the domain name and select **Delete**.

5. Select **OK** to apply your changes.

Parent topic: [Configuring Security Settings](#)

Using Your Product on a Secure Network

Follow the instructions in these sections to configure security features for your product on the network using the Web Config software.

[Configuring Protocols and Services in Web Config](#)

[Configuring SSL/TLS Communication](#)

[Configuring IPsec/IP Filtering](#)

[Connecting the Product to an IEEE 802.1X Network](#)

[Using a Digital Certificate](#)

Parent topic: [Administering Your Product](#)

Configuring Protocols and Services in Web Config

You can enable or disable protocols using Web Config.

1. Select or deselect the checkbox next to the service name to enable or disable a protocol.
2. Configure any other available protocol settings.
3. Click **Next**.
4. Click **OK**.
5. Select and configure services and protocol settings as necessary.

After the protocols restart, the changes are applied.

[Protocol Settings](#)

Parent topic: [Using Your Product on a Secure Network](#)

Protocol Settings

Protocols

Name	Description
Bonjour	Bonjour is used to search for devices and AirPrint
iBeacon	Enable the iBeacon setting to search for the product from iBeacon-enabled devices
SLP	SLP is used for push-scanning and network searching in EpsonNet Config
WSD	Add WSD devices, or print and scan from the WSD port

Name	Description
LLTD	Displays the product on the Windows network map
LLMNR	Use name resolution without NetBIOS even if you cannot use DNS
LPR	Print from to the LPR port
RAW(Port9100)	Print from the RAW port (Port 9100)
RAW(Custom Port)	Print from the RAW port (custom port)
IPP	Print over the Internet, including AirPrint
FTP	Print over FTP
SNMPv1/v2c	Remotely set up and monitor your product
SNMPv3	Remotely set up and monitor your product with the SNMPv3 protocol

Bonjour Settings

Setting	Options/Description
Use Bonjour	Search for or use devices through Bonjour (you cannot use AirPrint if disabled)
Bonjour Name	Displays the Bonjour name
Bonjour Service Name	Displays the Bonjour service name
Location	Displays the Bonjour location name
Top Priority Protocol	Selects the protocol that is the top priority for Bonjour printing
Wide-Area Bonjour	Enables the Wide-Area Bonjour protocol; register all products on the DNS server to locate them over the segment

iBeacon Settings

Setting	Options/Description
Enable iBeacon Transmission	Enable the iBeacon transmission function

SLP Settings

Setting	Options/Description
Enable SLP	Enable the SLP function to use the Push Scan function and network searching in EpsonNet Config

WSD Settings

Setting	Options/Description
Enable WSD	Enable adding devices using WSD, and printing and scanning from the WSD port
Printing Timeout (sec)	Enter the communication timeout value for WSD printing between 3 and 3,600 seconds
Scanning Timeout (sec)	Enter the communication timeout value for WSD scanning between 3 and 3,600 seconds
Device Name	Displays the WSD device name
Location	Displays the WSD location name

LLTD Settings

Setting	Options/Description
Enable LLTD	Enable LLTD to display the product in the Windows network map
Device Name	Displays the LLTD device name

LLMNR Settings

Setting	Options/Description
Enable LLMNR	Enable LLMNR to use name resolution without NetBIOS, even if you cannot use DNS

LPR Settings

Setting	Options/Description
Allow LPR Port Printing	Allow printing from the LPR port
Printing Timeout (sec)	Enter the timeout value for LPR printing between 0 and 3,600 seconds

RAW (Port9100) Settings

Setting	Options/Description
Allow RAW (Port9100) Printing	Allow printing from the RAW port (Port 9100)
Printing Timeout (sec)	Enter the timeout value for RAW port (Port 9100) printing between 0 and 3,600 seconds

RAW (Custom Port) Settings

Setting	Options/Description
Allow RAW (Custom Port) Printing	Allow printing from the RAW port (custom port)
Port Number	Enter the port number for RAW printing between 1024 and 65535 (except 9100, 1865, and 2968)
Printing Timeout (sec)	Enter the timeout value for RAW port (custom port) printing between 0 and 3,600 seconds

IPP Settings

Setting	Options/Description
Enable IPP	Enable IPP communication for products that support IPP are displayed (you cannot use AirPrint if disabled)
Allow Non-secure Communication	Allow the printer to communicate without any security measures (IPP)
Communication Timeout (sec)	Enter the timeout value for IPP printing between 0 and 3,600 seconds

Setting	Options/Description
Require PIN Code when using IPP printing	Select whether or not to require a PIN code when using IPP printing. If you select Yes , IPP print jobs without PIN codes are not saved in the product.
URL(Network)	Displays IPP URLs (http and https) when the product is connected using wired LAN or Wi-Fi (the URL is a combined value of the product's IP address, Port number, and IPP printer name)
URL(Wi-Fi Direct)	Displays IPP URLs (http and https) when the product is connected using Wi-Fi Direct (the URL is a combined value of the product's IP address, Port number, and IPP printer name)
Printer Name	Displays the IPP printer name
Location	Displays the IPP location

FTP Settings

Setting	Options/Description
Enable FTP Server	Enable FTP printing for products that support FTP printing
Communication Timeout (sec)	Enter the timeout value for FTP communication between 0 and 3,600 seconds

SNMPv1/v2c Settings

Setting	Options/Description
Enable SNMPv1/v2c	Enable SNMPv1/v2c for products that support SNMPv3
Access Authority	Set the access authority when SNMPv1/v2c is enabled to Read Only or Read/Write
Community Name (Read Only)	Enter 0 to 32 ASCII characters
Community Name (Read/Write)	Enter 0 to 32 ASCII characters

SNMPv3 Settings

Setting	Options/Description
Enable SNMPv3	Enable SNMPv3 for products that support SNMPv3
User Name	Enter 1 to 32 characters
Authentication Settings	Select an algorithm and set a password for authentication
Encryption Settings	Select an algorithm and set a password for encryption
Context Name	Enter 1 to 32 characters in Unicode (UTF-8)

Parent topic: [Configuring Protocols and Services in Web Config](#)

Configuring SSL/TLS Communication

Follow the instructions in these sections to configure SSL/TLS communication using Web Config.

[Configuring SSL/TLS Settings](#)

[Configuring a Server Certificate for the Product](#)

Parent topic: [Using Your Product on a Secure Network](#)

Configuring SSL/TLS Settings

If your product supports HTTPS, you can configure SSL/TLS to encrypt communications with your product.

1. Access Web Config and select **Network Security Settings**.
2. Select **SSL/TLS** and select **Basic**.
3. Select one of the options for the **Encryption Strength** setting.
4. Select **Enable** or **Disable** for the **Redirect HTTP to HTTPS** setting as necessary.
5. If necessary, enable a TLS version.
6. Click **Next**.
You see a confirmation message.
7. Click **OK**.

Parent topic: [Configuring SSL/TLS Communication](#)

Configuring a Server Certificate for the Product

You can configure a server certificate for your product.

1. Access Web Config and select the **Network Security** tab.
2. Under **SSL/TLS**, select **Certificate**.
3. Select one of the following options:
 - **CA-signed Certificate**: Select **Import** if you have obtained a CA-signed certificate. Choose the file to import and click **OK**.
 - **Self-signed Certificate**: Select **Update** if you have not obtained a CA (Certificate Authority)-signed certificate and want the product to generate a self-signed certificate.
4. Click **Next**.
You see a confirmation message.
5. Click **OK**.

Parent topic: [Configuring SSL/TLS Communication](#)

Configuring IPsec/IP Filtering

Follow the instructions in these sections to configure IPsec/IP traffic filtering using Web Config.

[About IPsec/IP Filtering](#)

[Configuring the Default IPsec/IP Filtering Policy](#)

[Configuring the Group IPsec/IP Filtering Policies](#)

[IPsec/IP Filtering Policy Settings](#)

[IPsec/IP Filtering Configuration Examples](#)

[Configuring an IPsec/IP Filtering Certificate](#)

Parent topic: [Using Your Product on a Secure Network](#)

About IPsec/IP Filtering

You can filter traffic to the product over the network based on IP address, service, and port by configuring a default policy that applies to every user or group connecting to the product. For control of individual users or user groups, you can configure group policies.

Note: IPsec is supported only by computers running Windows Vista or later, or Windows Server 2008 or later.

Parent topic: [Configuring IPsec/IP Filtering](#)

Configuring the Default IPsec/IP Filtering Policy

You can configure the default policy for IPsec/IP traffic filtering using Web Config.

1. Access Web Config and select the **Network Security** tab.
2. Under **IPsec/IP Filtering**, select **Basic**.
3. Select **Enable** to enable IPsec/IP filtering.
4. Select the filtering options you want to use for the default policy.
5. Click **Next**.
You see a confirmation message.
6. Click **OK**.

Parent topic: [Configuring IPsec/IP Filtering](#)

Configuring the Group IPsec/IP Filtering Policies

You can configure group policies for IPsec/IP traffic filtering using Web Config.

1. Access Web Config and select the **Network Security** tab.
2. Under **IPsec/IP Filtering**, select **Basic**.
3. Click a tab number for the policy number you want to configure.
4. Select the **Enable this Group Policy** checkbox.
5. Select the filtering options you want to use for this group policy.
6. Click **Next**.
You see a confirmation message.
7. Click **OK**.
8. If you want to configure additional group policies, click the next tab number and repeat the configuration steps as necessary.

Parent topic: [Configuring IPsec/IP Filtering](#)

IPsec/IP Filtering Policy Settings

Default Policy Settings

Setting	Options/Description
Access Control	Permit Access to permit IP packets to pass through Refuse Access to prevent IP packets from passing through IPsec to permit IPsec packets to pass through

Setting	Options/Description
Authentication Method	Select an authentication method, or select Certificate if you have imported a CA-signed certificate
Pre-Shared Key	If necessary, enter a pre-shared key between 1 and 127 characters long
Encapsulation	If you selected IPsec as the Access Control option, select one of these encapsulation modes: Transport Mode: if you are using the product on the same LAN; IP packets of layer 4 or later are encrypted Tunnel Mode: if you are using the product on an Internet-capable network, such as IPsec-VPN; the header and data of IP packets are encrypted
Remote Gateway(Tunnel Mode)	If you selected Tunnel Mode as the Encapsulation option, enter a gateway address between 1 and 39 characters long
Security Protocol	If you selected IPsec as the Access Control option, select one of these security protocols: ESP: to ensure the integrity of authentication and data, and encrypt data AH: to ensure the integrity of authentication and data; if data encryption is prohibited, you can use IPsec

Group Policy Settings

Setting	Options/Description
Access Control	Permit Access to permit IP packets to pass through Refuse Access to prevent IP packets from passing through IPsec to permit IPsec packets to pass through
Local Address(Printer)	Select an IPv4 or IPv6 address that matches your network environment; if the IP address is assigned automatically, select Use auto-obtained IPv4 address

Setting	Options/Description
Remote Address(Host)	Enter the device's IP address (between 0 and 43 characters long) to control access, or leave blank to control all addresses; if the IP address is assigned automatically, such as by DHCP, the connection may be unavailable, so configure a static address instead
Method of Choosing Port	Select the method you want to used for specifying ports
Service Name	If you selected Service Name as the Method of Choosing Port option, select a service name option here; see the next table for more information
Transport Protocol	If you selected Port Number as the Method of Choosing Port option, select one of these encapsulation modes: Any Protocol TCP UDP ICMPv4 See the Group Policy Guidelines table for more information.
Local Port	If you selected Port Number as the Method of Choosing Port option, and TCP or UDP for the Transport Protocol option, enter the port numbers that control receiving packets (up to 10 ports), separated by commas, for example 25,80,143,5220 ; leave this setting blank to control all ports; see the next table for more information
Remote Port	If you selected Port Number as the Method of Choosing Port option, and TCP or UDP for the Transport Protocol option, enter the port numbers that control sending packets (up to 10 ports), separated by commas, for example 25,80,143,5220 ; leave this setting blank to control all ports; see the next table for more information
Authentication Method	If you selected IPsec as the Access Control option, select an authentication method here

Setting	Options/Description
Pre-Shared Key	If you selected Pre-Shared Key as the Authentication Method option, enter a pre-shared key between 1 and 127 characters long here and in the Confirm Pre-Shared Key field
Encapsulation	If you selected IPsec as the Access Control option, select one of these encapsulation modes: Transport Mode: if you are using the product on the same LAN; IP packets of layer 4 or later are encrypted Tunnel Mode: if you are using the product on an Internet-capable network, such as IPsec-VPN; the header and data of IP packets are encrypted
Remote Gateway(Tunnel Mode)	If you selected Tunnel Mode as the Encapsulation option, enter a gateway address between 1 and 39 characters long
Security Protocol	If you selected IPsec as the Access Control option, select one of these security protocols: ESP: to ensure the integrity of authentication and data, and encrypt data AH: to ensure the integrity of authentication and data; if data encryption is prohibited, you can use IPsec

Group Policy Guidelines

Service name	Protocol type	Local/Remote port number	Controls these operations
ENPC	UDP	3289/Any port	Searching for a product from applications such as printer or scanner drivers, or EpsonNet Config
SNMP	UDP	161/Any port	Acquiring and configuring MIB from applications such as printer or scanner drivers, or EpsonNet Config
LPR	TCP	515/Any port	Forwarding LPR data
RAW (Port9100)	TCP	9100/any port	Forwarding RAW data

Service name	Protocol type	Local/Remote port number	Controls these operations
IPP/IPPS	TCP	631/Any port	Forwarding AirPrint data (IPP/IPPS printing)
WSD	TCP	Any port/5357	Controlling WSD
WS-Discovery	UDP	3702/Any port	Searching for a product from WSD
Network Scan	TCP	1865/Any port	Forwarding scan data from Document Capture Pro
Network Push Scan	TCP	Any port/2968	Acquiring job information on push scanning from Document Capture Pro
Network Push Scan Discovery	UDP	2968/Any port	Searching for a computer during push scanning from Document Capture Pro
FTP Data (Local)	TCP	20/Any port	Forwarding FTP printing data to FTP server
FTP Control (Local)	TCP	21/Any port	Controlling FTP printing to FTP server
FTP Data (Remote)	TCP	Any port/20	Forwarding scan data and received fax data to FTP client; controls only an FTP server that uses remote port 20
FTP Control (Remote)	TCP	Any port/21	Forwarding scan data and received fax data to FTP client
CIFS (Local)*	TCP	445/Any port	Sharing a network folder on CIFS server
CIFS (Remote)*	TCP	Any port/445	Forwarding scan data and received fax data to a folder on CIFS server

Service name	Protocol type	Local/Remote port number	Controls these operations
NetBIOS Name Service (Local)	UDP	137/Any port	Sharing a network folder on CIFS server
NetBIOS Datagram Service (Local)	UDP	138/Any port	
NetBIOS Session Service (Local)	TCP	139/Any port	
NetBIOS Name Service (Remote)	UDP	Any port/137	Forwarding scan data and received fax data to a folder on CIFS server
NetBIOS Datagram (Remote)	UDP	Any port/138	
NetBIOS Session Service (Remote)	TCP	Any port/139	
HTTP (Local)	TCP	80/Any port	Forwarding Web Config and WSD data to a HTTP or HTTPS server
HTTPS (Local)	TCP	443/Any port	
HTTP (Remote)	TCP	Any port/80	Communicating with Epson Connect, firmware update, and root certificate update on a HTTP or HTTPS client
HTTPS (Remote)	TCP	Any port/443	

* To control forwarding of scan and received fax data, share a network folder, or receive fax data from PC-Fax, select **Port Number** as the **Method of Choosing Port** option and specify the port numbers for CIFS and NetBIOS.

Parent topic: [Configuring IPsec/IP Filtering](#)

IPsec/IP Filtering Configuration Examples

You can configure IPsec and IP filtering in a variety of ways, as shown in the examples here.

Receiving IPsec Packets Only

Use this example only for configuring a default policy.

- **IPsec/IP Filtering: Enable**
- **Access Control: IPsec**
- **Authentication Method: Pre-Shared Key**

- **Pre-Shared Key:** Enter a key up to 127 characters long

Receiving Printing Data and Printer Settings

Use this example to allow communication of printing data and printer settings from specified services.

Default policy:

- **IPsec/IP Filtering:** Enable
- **Access Control:** Refuse Access

Group policy:

- **Access Control:** Permit Access
- **Remote Address(Host):** Client IP address
- **Method of Choosing Port:** Service Name
- **Service Name:** Select **ENPC**, **SNMP**, **HTTP (Local)**, **HTTPS (Local)**, and **RAW (Port9100)**

Receiving Access from Only a Specified Address for Product Access

In these examples, the client will be able to access and configure the product in any policy configuration.

Default policy:

- **IPsec/IP Filtering:** Enable
- **Access Control:** Refuse Access

Group policy:

- **Access Control:** Permit Access
- **Remote Address (Host):** Administrator's client IP address

Parent topic: [Configuring IPsec/IP Filtering](#)

Configuring an IPsec/IP Filtering Certificate

You can configure a certificate for IPsec/IP traffic filtering using Web Config.

1. Access Web Config and select the **Network Security** tab.
2. Under **IPsec/IP Filtering**, select **Client Certificate**.
3. Click **Import** to add a new client certificate and enter any necessary settings.
4. Click **OK**.

Parent topic: [Configuring IPsec/IP Filtering](#)

Connecting the Product to an IEEE 802.1X Network

Follow the instructions in these sections to connect the product to an IEEE 802.1X network using Web Config.

[Configuring an IEEE 802.1X Network](#)

[IEEE 802.1X Network Settings](#)

[Configuring a Certificate for an IEEE 802.1X Network](#)

[IEEE 802.1X Network Status](#)

Parent topic: [Using Your Product on a Secure Network](#)

Configuring an IEEE 802.1X Network

If your product supports IEEE 802.1X, you can use it on a network with authentication provided by a RADIUS server with a hub as an authenticator using Web Config.

1. Access Web Config and select the **Network Security** tab.
2. Under **IEEE802.1X**, select **Basic**.
3. Select **Enable** as the **IEEE802.1X (Wired LAN)** setting.
4. To use the product on a Wi-Fi network, enable your product's Wi-Fi settings. See your product's *User's Guide* for instructions.

The status of the connection is shown as the **IEEE802.1X (Wi-Fi)** setting.

Note: You can share the network settings for Ethernet and Wi-Fi networking.

5. Select the IEEE 802.1X setting options you want to use.
6. Click **Next**.
You see a confirmation message.
7. Click **OK**.

Parent topic: [Connecting the Product to an IEEE 802.1X Network](#)

IEEE 802.1X Network Settings

You can configure these IEEE 802.1X network settings in Web Config.

Setting	Options/Description
EAP Type	Select one of these authentication methods for connections between the product and a RADIUS server: EAP-TLS or PEAP-TLS : You must obtain and import a CA-signed certificate PEAP/MSCHAPv2 : You must configure a password
User ID	Enter an ID for authentication on a RADIUS server
Password	Enter a password for authentication of the product.
Confirm Password	Enter the authentication password again
Server ID	Enter a server ID for authentication on a specified RADIUS server; server ID is verified in the subject/subjectAltName field of a server certificate sent from the RADIUS server
Anonymous Name	If you selected PEAP-TLS or PEAP/MSCHAPv2 as the Authentication Method setting, you can configure an anonymous name instead of a user ID for phase 1 of a PEAP authentication
Encryption Strength	Select one of the following encryption strengths: High for AES256/3DES Middle for AES256/3DES/AES128/RC4

Parent topic: [Connecting the Product to an IEEE 802.1X Network](#)

Configuring a Certificate for an IEEE 802.1X Network

If your product supports IEEE 802.1X, you can configure a certificate for the network using Web Config.

1. Access Web Config and select the **Network Security** tab.
2. Under **IEEE802.1X**, select **Client Certificate**.
3. Click **Import** to add a new client certificate.
4. Click **OK**.

Parent topic: [Connecting the Product to an IEEE 802.1X Network](#)

IEEE 802.1X Network Status

You can check the status of the IEEE 802.1X network settings by printing a status sheet from your product.

The network status sheet displays the information in this table for IEEE 802.1X networks.

Status ID	Status description
Disable	IEEE 802.1X is disabled
EAP Success	IEEE 802.1X authentication is confirmed and the network connection is available
Authenticating	IEEE 802.1X authentication in progress
Config Error	Authentication failed because the user ID was not set
Client Certificate Error	Authentication failed because the client certificate is out of date
Timeout Error	Authentication failed because there is no answer from the RADIUS server and/or authenticator
User ID Error	Authentication failed because the product's user ID and/or certificate protocol is incorrect
Server ID Error	Authentication failed because the server ID on the server certificate and the server's ID do not match
Server Certificate Error	Authentication failed because the server certificate is out of date or the chain of the server certificate is incorrect
CA Certificate Error	Authentication failed because the CA certificate is incorrect, not imported, or out of date
EAP Failure	Authentication failed because the client certificate is incorrect (EAP-TLS or PEAP-TLS), or the user ID or password is incorrect (PEAP/MSCHAPv2)

Parent topic: [Connecting the Product to an IEEE 802.1X Network](#)

Using a Digital Certificate

Follow the instructions in these sections to configure and use digital certificates using Web Config.

[About Digital Certification](#)

[Obtaining and Importing a CA-signed Certificate](#)

[CSR Setup Settings](#)

[CSR Import Settings](#)

[Deleting a CA-signed Certificate](#)

[Updating a Self-signed Certificate](#)

[Importing a CA Certificate](#)

[Deleting a CA Certificate](#)

Parent topic: [Using Your Product on a Secure Network](#)

About Digital Certification

You can configure the following digital certificates for your network using Web Config:

CA-signed Certificate

You can ensure secure communications using a CA-signed certificate for each security feature. The certificates must be signed by and obtained from a CA (Certificate Authority).

Self-signed Certificate

A self-signed certificate is issued and signed by the product itself. You can use the certificate for only SSL/TLS communication, however security is unreliable and you may see a security alert in the browser during use.

Parent topic: [Using a Digital Certificate](#)

Obtaining and Importing a CA-signed Certificate

You can obtain a CA-signed certificate by creating a CSR (Certificate Signing Request) using Web Config and submitting it to a certificate authority. The CSR created in Web Config is in PEM/DER format. You can import one CSR created from Web Config at a time.

1. Access Web Config and select **Network Security**.
2. Select one of the available network security options and select a certificate option.
3. In the CSR section, select **Generate**.
4. Select the CSR setting options you want to use.
5. Click **OK**.

You see a completion message.

6. In the CSR section, click the **Download** option that matches the format specified by your certificate authority to download the CSR.

Caution: Do not generate another CSR or you may not be able to import a CA-signed certificate.

7. Submit the CSR to the certificate authority following the format guidelines provided by that authority.
8. Save the issued CA-signed certificate to a computer connected to the product.

Before proceeding, make sure the time and date settings are correct on your product. See the product's *User's Guide* for instructions.

9. In the CA Certificate section, click **Import**.
10. Select the format of the certificate as the **Server Certificate** setting.
11. Select the certificate import settings as necessary for the format and the source from which you obtained it.
12. Click **OK**.
You see a confirmation message.
13. Click **Confirm** to verify the certificate information.

Parent topic: [Using a Digital Certificate](#)

Related references

[CSR Setup Settings](#)

[CSR Import Settings](#)

CSR Setup Settings

You can select these settings when setting up a CSR in Web Config.

Note: The available key length and abbreviations vary by certificate authority, so follow the rules of that authority when entering information in the CSR.

Setting	Options/Description
Key Length	Select a key length for the CSR
Common Name	Enter a name or static IP address from 1 to 128 characters long; for example, Reception printer or https://10.152.12.225
Organization, Organizational Unit, Locality, State/Province	Enter information in each field as necessary, from 0 to 64 characters long in ASCII; separate any multiple names with commas
Country	Enter a two-digit country code number as specified by the ISO-3166 standard

Parent topic: [Using a Digital Certificate](#)

CSR Import Settings

You can configure these settings when importing a CSR in Web Config.

Note: The import setting requirements vary by certificate format and how you obtained the certificate.

Certificate format	Setting descriptions
PEM/DER format obtained from Web Config	<p>Private Key: Do not configure because the product contains a private key</p> <p>Password: Do not configure</p> <p>CA Certificate 1/CA Certificate 2: Optional</p>
PEM/DER format obtained from a computer	<p>Private Key: Configure a private key</p> <p>Password: Do not configure</p> <p>CA Certificate 1/CA Certificate 2: Optional</p>
PKCS#12 format obtained from a computer	<p>Private Key: Do not configure</p> <p>Password: Optional</p> <p>CA Certificate 1/CA Certificate 2: Do not configure</p>

CA-signed Certificate Import Settings

Setting	Description
Server Certificate or Client Certificate	<p>Select the certificate format.</p> <p>For an SSL/TLS connection, the Server Certificate is displayed.</p> <p>For an IPsec/IP Filtering, IEEE802.1x, or S/MIME connection, the Client Certificate is displayed.</p> <p>Note: Depending on your product, not all connection types may be available.</p>
Private Key	<p>If you obtain a certificate of the PEM/DER format by using a CSR created from a computer, specify a private key file that matches the certificate.</p>
Password	<p>If the file format is Certificate with Private Key (PKCS#12), enter the password for encrypting the private key that is set when you obtain the certificate.</p>

Setting	Description
CA Certificate 1	If your certificate's format is Certificate (PEM/DER) , import a certificate from a certificate authority that issues a CA-signed Certificate to be used as the server certificate. Specify a file if necessary.
CA Certificate 2	If your certificate's format is Certificate (PEM/DER) , import a certificate from the same certificate authority that issued CA Certificate 1. Specify a file if necessary.

Parent topic: [Using a Digital Certificate](#)

Deleting a CA-signed Certificate

You can delete an imported CA-signed certificate with Web Config when the certificate expires or if you have no more need for an encrypted connection.

Note: If you obtained a CA-signed certificate from Web Config, you cannot import a deleted certificate; you must obtain and import a new certificate.

1. Access Web Config and select **Network Security**.
2. Click **Delete**.
You see a completion message.
3. Click **OK**.

Parent topic: [Using a Digital Certificate](#)

Updating a Self-signed Certificate

If your product supports the HTTPS server feature, you can update a self-signed certificate using Web Config.

1. Access Web Config and select **Network Security**, select **SSL/TLS**, and select **Certificate**.
2. Click **Update**.
3. Enter an identifier for your product from 1 to 128 characters long in the **Common Name** field.
4. Select a validity period for the certificate as the **Certificate Validity (year)** setting.
5. Click **Next**.

You see a completion message.

6. Click **OK**.
7. Click **Confirm** to verify the certificate information.

Parent topic: [Using a Digital Certificate](#)

Importing a CA Certificate

You can import a CA certificate using Web Config.

1. Access Web Config and select **Network Security**.
2. Select **CA Certificate**.
3. Select **Import**.
4. Select the CA certificate you want to import.
5. Click **OK**.

When you see the **CA Certificate** page and the imported certificate is displayed, the import is finished.

Parent topic: [Using a Digital Certificate](#)

Deleting a CA Certificate

You can delete an imported CA certificate with Web Config when the certificate expires or if you have no more need for an encrypted connection.

1. Access Web Config and select **Network Security Settings**.
2. Select **CA Certificate**.
3. Locate the certificate you want to remove and click the **Delete** button next to it.
4. Click **OK** to confirm the deletion.
5. Click **Reboot Network**, and then check that the deleted CA Certificate is not listed on the updated screen.

Parent topic: [Using a Digital Certificate](#)

Setting Up Universal Print (Microsoft)

You can set up your product for use with Universal Print if you are using Microsoft 365 and Azure Active Directory.

Note: This feature is supported on Windows 10 2004 (20H1) or later. Visit the Microsoft website for more information.

1. Access Web Config and select the **Network** tab.

2. Select **Universal Print**.
3. Select **Register**.
4. Follow the on-screen instructions to register your product.

Parent topic: [Administering Your Product](#)

Using Epson Device Admin Configuration Software

With Windows, you can discover and monitor remote devices, and configure network settings in a batch operation. See the Epson Device Admin help for instructions.

To install Epson Device Admin, download the software from the support page at epson.com/support (U.S.), epson.ca/support (Canada), or latin.epson.com/support (Caribbean) and follow the on-screen instructions.

Parent topic: [Administering Your Product](#)

Solving Problems

Check these sections for solutions to problems you may have using your product.

[Viewing the Help Screen](#)

[Product Status Messages](#)

[Job Status Error Codes](#)

[Running a Product Check](#)

[Resetting Control Panel Defaults](#)

[Solving Setup Problems](#)

[Solving Network Problems](#)

[Solving Network Security Problems](#)

[Solving Copying Problems](#)

[Solving Copy Quality Problems](#)

[Solving Paper Problems](#)

[Solving Problems Printing from a Computer](#)

[Solving Page Layout and Content Problems](#)

[Solving Print Quality Problems](#)

[Solving Scanning Problems](#)

[Solving Scanned Image Quality Problems](#)

[Solving Faxing Problems](#)

[Solving USB Device Problems](#)

[Uninstall Your Product Software](#)

[Where to Get Help \(U.S. and Canada\)](#)

[Where to Get Help \(Latin America\)](#)

Viewing the Help Screen

You can view troubleshooting or how-to topics on the LCD screen at any time.

1. Select the  help icon.

You see this screen:

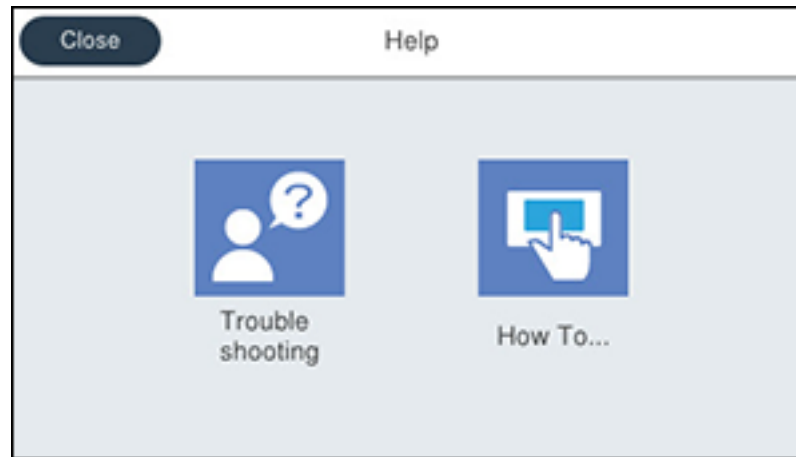

2. Select **Troubleshooting** or **How To** to view instructional images or animations.

Parent topic: [Solving Problems](#)

Product Status Messages

You can often diagnose problems with your product by checking the messages and status icons on its LCD screen. You can also check for errors by pressing the  **Job/Status** button and selecting **Printer Status**.

Note: If the screen is dark, press the screen to wake the product from sleep mode.

LCD screen message	Condition/solution
Printer error. Turn the power off and on again. If the problem persists, contact Epson support.	Turn the product off and then back on again. If the error persists, check for and remove any jammed paper or protective materials from the product. If the error still persists, contact Epson for support. If you see any of the following error codes, make sure you have not exceeded the loading capacity for any paper source: <ul style="list-style-type: none"> • 000181 • 000184
Printer error. Contact Epson support. Non-printing features are available.	The product may be damaged, but features such as scanning are still available. Contact Epson for support.
Printer error. For details, see your documentation.	The product may be damaged. Contact Epson for support.
Paper out in XX. Load Paper. Paper Size: XX/Paper Type: XX	Load the size and type of paper in the paper source indicated.
Too many paper cassette units are installed. Turn the power off and uninstall the extra units. See your documentation for details.	You can install up to three optional paper cassette units. Remove any extra units.
Unsupported Paper Cassette Units have been installed. Turn the power off and uninstall. For details, see your documentation.	Unsupported optional paper cassette units are installed. Remove the unsupported units.
Cannot print because XX is out of order. You can print from another cassette.	Turn the product off and then back on again. Reinsert the indicated paper cassette. If the error persists, contact Epson for support.
The pickup roller in XX is nearing the end of its service life.	The paper cassette rollers need to be replaced periodically for optimal performance. (Paper may not feed correctly from the paper cassette when the roller is near the end of its service life.) Contact Epson for support.
The pickup roller in XX has reached the end of its service life. Replace it and reset the maintenance roller counter.	Replace the paper cassette roller indicated and reset the counter. Contact Epson for support.

LCD screen message	Condition/solution
You need to replace Ink Supply Unit(s).	Replace the indicated ink packs.
Paper Setup Auto Display is set to Off. Some features may not be available. For details, see your documentation.	AirPrint is not available when the Paper Setup Auto Display setting is disabled. Change Paper Setup Auto Display to On .
No dial tone is detected.	Make sure the phone cable is connected correctly and the phone line works. If you connected the product to a PBX (Private Branch Exchange) phone line or Terminal Adapter, change the Line Type setting to PBX . If you still cannot send a fax, turn off the Dial Tone Detection setting. (Turning off the Dial Tone Detection setting may cause the product to drop the first digit of a fax number.)
Failed to receive faxes because the fax data capacity is full. Touch the Job/Status at the bottom of the Home Screen for details.	Press the  Job/Status button and select Printer Status and resolve any printer errors that prevented faxes from printing. Make sure the product is connected to a computer or that a USB device is connected to the product.
The combination of the IP address and the subnet mask is invalid. See your documentation for more details.	There is a problem with the network connection to your product. Set up your product on the network again.
To use cloud services, update the root certificate from the Epson Web Config utility.	Access the Web Config utility and update the cloud service root certificate.
Check that the printer driver is installed on the computer and that the port settings for the printer are correct.	Make sure the printer port is correctly configured. In Windows, make sure the port is set to a USBXXX setting for a USB connection or EpsonNet Print Port for a network connection.
Recovery Mode Update Firmware	An error has occurred during firmware updating. Connect your product using a USB cable and try downloading the Firmware Update from the Epson support site. If you still need help, contact Epson for support.

Parent topic: [Solving Problems](#)

Related references

[Paper Source Settings Options](#)

Related tasks

- [Loading Paper in the Paper Cassettes and Rear Paper Tray](#)
- [Installing the Optional Paper Cassette Units](#)
- [Replacing the Paper Feed Rollers](#)
- [Removing and Installing Ink Packs](#)
- [Connecting a Telephone or Answering Machine](#)

Related topics

- [Wi-Fi or Wired Networking](#)
- [Using a Digital Certificate](#)

Job Status Error Codes

If a job does not complete successfully, you can check the error code for the reason. Press the  **Job/Status** button, select the **Job/Status** tab, and select **Log**. Select the incomplete job to display the error code and additional information.

Code	Condition/solution
001	The product was turned off by a power failure.
101	Memory is full. Reduce the size of the print job.
102	Collated printing has failed due to a lack of available memory. Clear fonts and macros from the product's memory using the PDL Font, Macro option on the Settings > General Settings > System Administration > Clear Internal Memory Data menu, reduce the size of the print job, or print one copy at a time.
103	Print quality was decreased due to a lack of available memory. If the quality of the printout is unacceptable, try simplifying the page by reducing the number of graphics or the number and size of the fonts.
104	Reverse printing has failed due to a lack of available memory. Clear fonts and macros from the product's memory using the PDL Font, Macro option on the Settings > General Settings > System Administration > Clear Internal Memory Data menu or reduce the data size of the print job.
106	Cannot print from the computer due to access control settings. Contact your product administrator.
107	User authentication failed and the job has been canceled. Contact your product administrator.
108	Confidential job data was deleted when the product was turned off.

Code	Condition/solution
109	The received fax was already deleted.
110	The job was printed 1-sided because the loaded paper does not support 2-sided printing.
111	Available memory is running low. Reduce the size of the print job.
120	Cannot communicate with a server using an open platform. Check the server or network for errors.
201	The product's memory is full. You can send pages individually, or print received faxes and delete them to free up memory space.
202	The line was disconnected by the recipient's fax machine. Wait a moment, then try again.
203	The product cannot detect a dial tone. Make sure the phone cable is connected correctly and the phone line works. If you connected the product to a PBX (Private Branch Exchange) phone line or Terminal Adapter, change the Line Type setting to PBX . If you still cannot send a fax, turn off the Dial Tone Detection setting. (Turning off the Dial Tone Detection setting may cause the product to drop the first digit of a fax number.)
204	The recipient's fax machine is busy. Wait a moment, then try again.
205	The recipient's fax machine does not answer. Wait a moment, then try again.
206	The phone cable is incorrectly connected to the product's LINE and EXT ports. Connect the phone cable correctly.
207	The phone cable is not connected. Connect the phone cable.
208	The fax could not be sent to some of the specified recipients. Print a fax log to check which recipients failed to receive the fax. If the Save Failure Data setting is turned on, you can resend a fax from Job Status in the Job/Status menu.
301 401	There is not enough storage space available to save the data in the external memory device. Clear space on the device or use a different device.
302 402	The external memory device is write-protected. Disable write protection.
303	No folder is available for saving the scanned file. Create a folder or use a different memory device.

Code	Condition/solution
304 404	The external memory device has been removed. Reinsert the device.
305 405	An error occurred while saving data to an external memory device. Reinsert the memory device or use a different device.
306	The product's memory is full. Wait until current jobs are finished processing.
311 321 411 421	A DNS error has occurred. Check the DNS settings for the server, computer, or access point. DNS settings for the server can be checked from the DNS Server option in the Setup menu.
312 412	An authentication error has occurred. Check the Server Settings in the Settings menu.
313 413	A communication error has occurred. Check the network connection or Server Settings in the Settings menu.
314	The data size exceeds the maximum size for the attached files. Increase the Attached File Max Size setting in the scan settings or lower the file size of the scanned image.
315 327	The memory is full. Retry after other ongoing jobs have finished.
316	A mail encryption error occurred. Make sure the encryption certificate setting and the product's time setting are correct. Contact your product administrator.
317	A mail signature error occurred. Make sure the signing certificate setting and the product's time setting are correct. Contact your product administrator.
322	An authentication error occurred. Check the Location settings.
323	A communication error has occurred. Check the Location settings or the network connection.
324	A file with the same name already exists in the specified folder. Delete the duplicate file or change the file name prefix in File Settings .
325 326	There is not enough storage space available in the specified folder. Increase the storage space in the specified folder, delete unnecessary files, or lower the file size of the scanned image.

Code	Condition/solution
328	The destination was wrong or the destination does not exist. Check the Location settings.
330	An FTPS/FTPS secure connection error occurred. Check the location in the destination settings. Run Epson Web Config and update the root certificate or the CA certificate. Contact your product administrator.
331	A communication error occurred while acquiring the destination list. Make sure the product is connected to the network correctly.
332	There is not enough space available for saving the scanned files in the specified folder. Delete unnecessary files from the specified folder.
333	The destination could not be found because the destination information was uploaded to the server before sending the scanned data. Select the destination again.
334	An error occurred while sending the scanned data.
341	A communication error has occurred. Make sure the product is connected to the computer or network correctly. Make sure you have installed Document Capture Pro or Document Capture. Make sure the Event Manager program is not being blocked by your firewall or security software.
350	An FTPS/HTTPS certificate error occurred. Check the product's date and time settings are correct. Run Epson Web Config and update the root certificate or the CA certificate. Contact your product administrator.
422	An authentication error has occurred. Make sure the settings are correct for the folder selected in Save/Forward Settings in the Settings menu.
423	A communication error has occurred. It is also possible that a file with the same name is open or the file is a read-only file. Check the network connection, make sure the settings are correct for the folder selected in the in Save/Forward Settings in the Settings menu, close the duplicate file, or disable read-only protection.
425	There is not enough storage space available in the forwarding destination folder. Increase the storage space in the destination folder.
428	The destination was wrong or the destination does not exist. Make sure the settings are correct for the folder selected in Save/Forward Settings in the Settings menu.

Parent topic: [Solving Problems](#)

Related references

[Double-sided Printing Capacity](#)

Related tasks

[Clearing the Internal Memory](#)

[Connecting an Authentication Device](#)

Related topics

[Restricting Features Available for Users](#)

[Setting Up and Scanning to a Network Folder or FTP Server](#)

Running a Product Check

Running a product check helps you determine if your product is operating properly.

1. Disconnect any interface cables connected to your product.
2. Load plain paper in the product.
3. Press the  home button, if necessary.
4. Select **Settings** > **Maintenance** > **Print Head Nozzle Check**.

You see a screen like this:

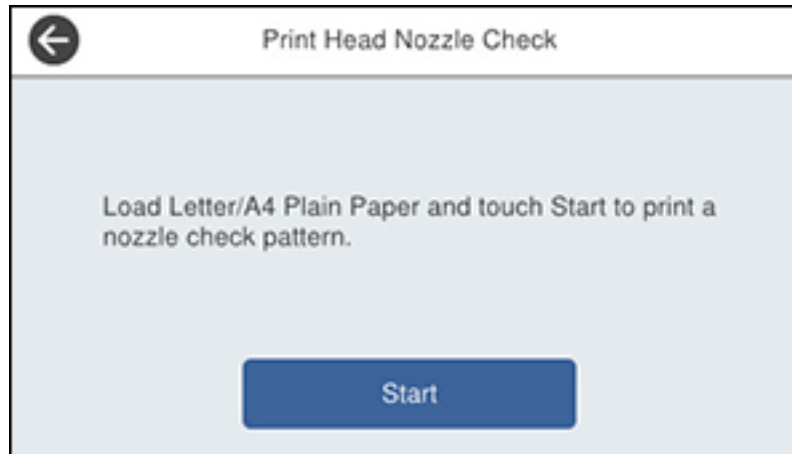

5. Select **Start**.
The nozzle pattern prints.

6. Do one of the following, depending on the results of the product check:
 - If the page prints and the nozzle check pattern is complete, the product is operating properly. Any operation problem you may have could be caused by your computer, cable, software, or selected settings. Check the other solutions in this book or try uninstalling and reinstalling your printer software.
 - If the page prints but the nozzle check pattern has gaps, clean the print head.
 - If the page does not print, the product may have a problem. Check the other solutions in this manual. If they do not work, contact Epson.

Parent topic: [Solving Problems](#)

Resetting Control Panel Defaults

If you have a problem with settings on the product control panel, you can reset them to their factory defaults. You can choose which settings to reset or reset them all.

Note: This setting can be locked by an administrator. If you cannot access or change this setting, contact your administrator for assistance.

1. Press the  home button, if necessary.
2. Select **Settings > General Settings > System Administration > Restore Default Settings**.

Note: You may need to enter the administrator password.

You see a screen like this:



3. Select one of these options:
 - **Network Settings:** Resets all network settings
 - **Copy Settings:** Resets all settings for copying
 - **Scan Settings:** Resets all settings for scanning
 - **Fax Settings:** Resets all settings for faxing
 - **Clear All Data and Settings:** Resets all control panel settings including the contacts list

You see a confirmation screen.

4. Select **Yes** to reset the selected settings. (Select **No** if you want to cancel the operation.)

Parent topic: [Solving Problems](#)

Solving Setup Problems

Check these sections if you have problems while setting up your product.

[Product Does Not Turn On or Off](#)

[Noise After Ink Installation](#)

[Software Installation Problems](#)

[Cannot Read the Authentication Card](#)

Parent topic: [Solving Problems](#)

Product Does Not Turn On or Off

If you cannot turn the product on or off, try these solutions:

- If you cannot turn on your product, make sure the power cord is securely connected and hold down the power button a little longer.
- If you cannot turn off your product, hold down the power button a little longer. If you still cannot turn off your product, unplug the power cord, plug the power cord back in, then turn your product on and off again using the power button.

Parent topic: [Solving Setup Problems](#)

Noise After Ink Installation

If you hear noises from your product after installing ink, check the following:

- The first time you install the ink packs, the product must charge its print head. Wait until charging finishes before you turn off the product, or it may charge improperly and use excess ink the next time you turn it on.
- If the product's print head stops moving or making noise, and the charging process has not finished after approximately 5 minutes, turn off your product. Turn it back on and check to see if charging is still in progress. If it is still in progress, contact Epson for help.

Parent topic: [Solving Setup Problems](#)

Software Installation Problems

If you have problems while installing your product software, try these solutions:

- Make sure your product is turned on and any necessary cables are securely connected at both ends. If you still have problems installing software, disconnect the cable and carefully follow the instructions on the *Start Here* sheet. Also make sure your system meets the requirements for your operating system.
- Close any other programs, including screen savers and virus protection software, and install your product software again.
- In Windows, make sure your product is selected as the default printer and the correct port is shown in the printer properties.
- For Mac, make sure your product is shown in the printer list. Click **System Preferences** or **System Settings** > **Printers & Scanners** or **Print & Fax**. If the printer name is not displayed, add the printer.
- If you see any error message or your software does not install correctly in Windows, you may not have software installation privileges. Contact your system administrator.

- If you are printing over a network, make sure your product is set up properly on the network.
- If the USB cable is not recognized, try using a different USB cable.

Parent topic: [Solving Setup Problems](#)

Related concepts

[Uninstall Your Product Software](#)

Cannot Read the Authentication Card

If the IC card reader cannot read the authentication card, try these solutions:

- Make sure the card reader is securely connected to the external USB port on the back of the product.
- Make sure both the card reader and the authentication card are supported.

Parent topic: [Solving Setup Problems](#)

Related tasks

[Connecting an Authentication Device](#)

Solving Network Problems

Check these solutions if you have problems setting up or using your product on a network.

Note: Breakdown or repair of this product may cause loss of fax and network data and settings. Epson is not responsible for backing up or recovering data and settings during or after the warranty period. We recommend that you make your own backup or print out your fax and network data and settings.

[Product Cannot Connect to a Wireless Router or Access Point](#)

[Network Software Cannot Find Product on a Network](#)

[Wireless Network Connection is Unstable on a Mac](#)

[USB 3.0 Connection is Unstable When Using a USB 2.0 Cable](#)

[Product Does Not Appear in Mac Printer Window](#)

[Cannot Print Over a Network](#)

[Cannot Scan Over a Network](#)

Parent topic: [Solving Problems](#)

Product Cannot Connect to a Wireless Router or Access Point

If your product has trouble finding or connecting to a wireless router or access point, try these solutions:

- If you are connecting the product via Wi-Fi Protected Setup (WPS) and the Wi-Fi icon on your product's LCD screen is not lit or does not appear, make sure you select one of the WPS options from the product control panel within 2 minutes of pressing the WPS button on your router.
- Make sure to place your product within contact range of your router or access point. Avoid placing your product near a microwave oven, cordless phone, or large metal object, such as a filing cabinet.

Note for Latin America: If you are using a 5 GHz wireless router, set the router to operate in dual band (2.4 GHz and 5 GHz) mode. If your router uses a single network name (SSID) for both the 2.4 GHz and 5 GHz band, give each band its own network name (SSID) instead, such as Home Network 2.4 GHz and Home Network 5 GHz. See your router documentation or contact your internet service provider for instructions.

- Verify that your router or access point is operating correctly by connecting to it from your computer or another device.
- Print a network connection report and check the codes and messages on the report to help determine the cause of the problem.
- You may need to disable the firewall and any anti-virus software on your wireless router or access point.
- Try restarting your router following the instructions in your router documentation.

Note: If you are reading these instructions online, you will lose your Internet connection when you restart your router.

- Check to see if access restrictions, such as MAC address filtering, are set on the router or access point. If access restrictions are set, add your product's MAC address to your router's address list. To obtain your product's MAC address, print a network status sheet. Then follow the instructions in your router or access point documentation to add the address to the list.
- If your router or access point does not broadcast its network name (SSID), follow the instructions that came with your product to enter your wireless network name manually.
- If your router or access point has security enabled, determine the kind of security it is using and any required password or passphrase for connection. Then make sure to enter the exact WEP key or WPA passphrase correctly.
- Check if your computer is restricting the available wireless channels. If so, verify that your wireless access point is using one of the usable channels and change to a usable channel, if necessary.

- If the IP address assigned to the product is 169.254.XXX.XXX and the subnet mask is 255.255.0.0, the IP address may not be assigned correctly. Check the IP address and the subnet mask assigned to the product. Restart the wireless router or reset the network settings for the product.
- If you cannot connect your product to a device using Wi-Fi Direct, you may have exceeded the maximum number of devices connected to your product (8). Print a network status sheet or access Web Config on the browser for your device and check the number of connected devices. If 8 devices are already connected, disconnect a device by deleting the product's SSID from the Wi-Fi screen of that device. If fewer than 8 devices are connected, check the accuracy of your other network settings, move your device closer to your product, and try connecting again.
- If you are using a Wi-Fi Direct connection that suddenly disconnects, the Wi-Fi Direct password on your device may have been changed. If necessary, delete the existing **DIRECT-xxxxxxx** connection settings from your device and enter a new password. See your device documentation for instructions.

Parent topic: [Solving Network Problems](#)

Related concepts

[Uninstall Your Product Software](#)

Related tasks

[Printing a Network Connection Report](#)

[Restoring Default Product Settings](#)

Network Software Cannot Find Product on a Network

If EpsonNet Setup cannot find your product on a network, try these solutions:

- Make sure your product is turned on and connected to your network. Verify the connection using your product control panel.
- Check if your network name (SSID) contains non-ASCII characters. Your product cannot display non-ASCII characters.
- Print a network connection report and check the codes and messages on the report to help determine the cause of the problem.
- Make sure your product is not connected to a guest network.
- If necessary, reinstall your product software and try running EpsonNet Setup again:
 1. Reset your product's network settings to their factory defaults.
 2. **Windows only:** Uninstall your product software.
 3. Restart your router following the instructions in your router documentation.

Note: If you are reading these instructions online, you will lose your Internet connection when you restart your router, so note the next step before restarting it.

4. Download your product software from the Epson website using the instructions on the *Start Here* sheet.
- If you have replaced your router, reinstall your product software to connect to the new router.

Note for Latin America: If you are using a 5 GHz wireless router, set the router to operate in dual band (2.4 GHz and 5 GHz) mode. If your router uses a single network name (SSID) for both the 2.4 GHz and 5 GHz band, give each band its own network name (SSID) instead, such as Home Network 2.4 GHz and Home Network 5 GHz. See your router documentation or contact your internet service provider for instructions.

- Check to see if your wireless router or access point has an enabled Privacy Separator function that is preventing detection of your device over the network. See your router or access point documentation for instructions on disabling the Privacy Separator function.

Parent topic: [Solving Network Problems](#)

Related concepts

[Uninstall Your Product Software](#)

Related tasks

[Printing a Network Connection Report](#)

[Restoring Default Product Settings](#)

Wireless Network Connection is Unstable on a Mac

If you connected a device to a USB 3.0 port on your Mac, you may experience wireless network interference between your product and your Mac.

If you cannot connect to your product over the wireless network or the connection becomes unstable, move the device connected to your Mac USB 3.0 port further away from your Mac.

Parent topic: [Solving Network Problems](#)

USB 3.0 Connection is Unstable When Using a USB 2.0 Cable

If you receive a communication error or experience an unstable connection when using a SuperSpeed USB port on your computer with a USB 2.0 cable, try these solutions:

- Use a USB 3.0 cable.
- Connect to a Hi-Speed USB port on your computer, if available.

- Connect to another SuperSpeed USB port on your computer, if available.

Parent topic: [Solving Network Problems](#)

Product Does Not Appear in Mac Printer Window

If your product does not appear in the Mac printer window, try these solutions:

- Turn your product off, wait 30 seconds, then turn it back on again.
- If you are connecting the product wirelessly via EpsonNet Setup and you do not see the Wi-Fi antenna icon with connection bars on your LCD screen, make sure your product software was installed correctly. If necessary, reinstall your software.

Parent topic: [Solving Network Problems](#)

Cannot Print Over a Network

If you cannot print over a network, try these solutions:

- Make sure that your product is turned on.
- Make sure you install your product's network software as described in your product documentation.
- Print a network status sheet and verify that the network settings are correct. If the network status is **Disconnected**, check any cable connections and turn your product off and then on again.
- Print a network connection report and check the codes and messages on the report to help determine the cause of the problem.
- If you are using TCP/IP, make sure the product's IP address is set correctly for your network. If your network does not assign IP addresses using DHCP, set the IP address manually. If the IP address assigned to the printer is 169.254.xxx.xxx and the subnet mask is 255.255.0.0, the IP address may not be assigned correctly. Restart your wireless router or reset the printer's network settings.
- Make sure your computer and product are both using the same wireless network.
- If network printing is slow, print a network status sheet and check the signal strength. If it is poor, place your product closer to your router or access point. Avoid placing your product near a microwave oven, cordless phone, or large metal object, such as a filing cabinet.

Note for Latin America: If you are using a 5 GHz wireless router, set the router to operate in dual band (2.4 GHz and 5 GHz) mode. If your router uses a single network name (SSID) for both the 2.4 GHz and 5 GHz band, give each band its own network name (SSID) instead, such as Home Network 2.4 GHz and Home Network 5 GHz. See your router documentation or contact your internet service provider for instructions.

- Try restarting your router following the instructions in your router documentation.

Note: If you are reading these instructions online, you will lose your Internet connection when you restart your router.

- Check if there are any paused print jobs.
- Make sure your printer is selected as the default printer.
- Check if the selected printer port is correct.
- Check to see if your wireless router or access point has an enabled Privacy Separator function that is preventing printing from a device over the network. See your router or access point documentation for instructions on disabling the Privacy Separator function.
- If you are connecting the product via Wi-Fi Protected Setup (WPS) and the Wi-Fi icon on your product's LCD screen is not lit, make sure you select one of the WPS options from the product control panel within 2 minutes of pressing the WPS button on your router.
- Check your wired LAN router or access point to see if the LED for the port to which your product is connected is on or flashing. If the link LED is off, try the following:
 - Make sure the Ethernet cable is securely connected to your product and to your router, access point, switch, or hub.
 - Try connecting your product to a different port or a different router, access point, switch, or hub.
 - Try connecting with a different Ethernet cable.
 - Try printing to your product from another computer on the network.
- If you are connecting the product via EpsonNet Setup and the Wi-Fi icon does not appear lit on the LCD screen, make sure your product software was installed correctly. If necessary, reinstall your software.

Parent topic: [Solving Network Problems](#)

Related concepts

[Uninstall Your Product Software](#)

Related tasks

[Printing a Network Status Sheet](#)

[Printing a Network Connection Report](#)

Cannot Scan Over a Network

If you have problems scanning over a network, try these solutions:

- If you cannot scan from your product control panel, make sure you restarted your computer after installing the product software. Make sure the Event Manager program is not being blocked by your firewall or security software.

Note for Latin America: If you are using a 5 GHz wireless router, set the router to operate in dual band (2.4 GHz and 5 GHz) mode. If your router uses a single network name (SSID) for both the 2.4 GHz and 5 GHz band, give each band its own network name (SSID) instead, such as Home Network 2.4 GHz and Home Network 5 GHz. See your router documentation or contact your internet service provider for instructions.

- If you are scanning a large original at a high resolution, a network communication error may occur. Try scanning again at a lower resolution.
- If network communication was interrupted while starting Epson Scan 2, exit Epson Scan 2, wait a few seconds, and restart it. If Epson Scan 2 cannot restart, turn off your product, turn it back on, and try restarting Epson Scan 2 again.
- Check the scanner setting and reset the connection if necessary using Epson Scan 2 Utility:

Windows 11: Click , then search for **Epson Scan 2 Utility** and select it. Make sure your product is selected. If necessary, select the **Other** tab and click **Reset**.

Windows 10: Click  and select **EPSON > Epson Scan 2 Utility**. Make sure your product is selected. If necessary, select the **Other** tab and click **Reset**.

Windows 8.x: Navigate to the **Apps** screen, select **EPSON**, and select **Epson Scan 2 Utility**. Make sure your product is selected. If necessary, select the **Other** tab and click **Reset**.

Windows (other versions): Click  or **Start > All Programs** or **Programs > EPSON > Epson Scan 2 > Epson Scan 2 Utility**. Make sure your product is selected. If necessary, select the **Other** tab and click **Reset**.

Mac: Open the **Applications** folder, click **Epson Software**, and click **Epson Scan 2 Utility**. Make sure your product is selected. If necessary, select the **Other** tab and click **Reset**.

- You may need to disable the firewall and any anti-virus software on your wireless router or access point.

Parent topic: [Solving Network Problems](#)

Related concepts

[Scan Resolution Guidelines](#)

Solving Network Security Problems

Check these sections if you have problems using the network security features.

[Cannot Create the Secure IPP Printing Port](#)

[Cannot Update a Certificate or Create a CSR](#)

[Cannot Import a Digital Certificate](#)

[Deleted a CA-signed Certificate](#)

[Digital Certificate Warning Messages](#)

Parent topic: [Solving Problems](#)

Cannot Create the Secure IPP Printing Port

If you cannot create the secure IPP printing port, try these solutions:

- Make sure you specified the correct server certificate for SSL/TLS communication using Web Config.
- If you are using a CA certificate, make sure it is imported to the computer that is accessing the product.

Parent topic: [Solving Network Security Problems](#)

Related tasks

[Importing a CA Certificate](#)

Related topics

[Configuring SSL/TLS Communication](#)

Cannot Update a Certificate or Create a CSR

If you cannot update a self-signed certificate or create a CSR for a CA-signed certificate, try these solutions:

- Make sure that you entered a **Common Name** setting in Web Config.
- Make sure the **Common Name** setting does not contain unsupported characters or is divided by a comma. Correct the setting and update the certificate again.

Parent topic: [Solving Network Security Problems](#)

Related references

[CSR Setup Settings](#)

[CSR Import Settings](#)

Related tasks

[Obtaining and Importing a CA-signed Certificate](#)

Cannot Import a Digital Certificate

If you cannot import a digital certificate, try these solutions:

- Make sure the CA-signed certificate and the CSR have the same information. If they do not match, import the certificate to a device that matches the information or use the CSR to obtain the CA-signed certificate again.
- Make sure the CA-signed certificate file size is 5KB or less.
- Make sure you are entering the correct password.

Parent topic: [Solving Network Security Problems](#)

Related references

[CSR Setup Settings](#)

[CSR Import Settings](#)

Related tasks

[Obtaining and Importing a CA-signed Certificate](#)

Deleted a CA-signed Certificate

If you accidentally deleted a CA-signed certificate, try these solutions:

- If you retained a backup file, import the CA-signed certificate again.
- If you obtained the certificate using a CSR created in Web Config, you cannot import a deleted certificate. Create a new CSR and obtain a new certificate.

Parent topic: [Solving Network Security Problems](#)

Related references

[CSR Setup Settings](#)

[CSR Import Settings](#)

Related tasks

[Obtaining and Importing a CA-signed Certificate](#)

Digital Certificate Warning Messages

If you see a warning message when using a digital certificate, check for solutions in this table.

Message	Solution
Enter a Server Certificate.	Select a certificate file and click Import .
CA Certificate 1 is not entered.	Import CA certificate 1 before importing additional certificates.
Invalid value below.	Remove any unsupported characters in the file path and password.
Invalid date and time.	Set the date and time on the product using Web Config, EpsonNet Config, or the product control panel.
Invalid password	Enter the password that matches the password set for the CA certificate.
Invalid file	Try the following: <ul style="list-style-type: none"> • Import only certificate files in X509 format sent by a trusted certificate authority. • Make sure the file size is 5KB or less and is not corrupted or fabricated. • Make sure the chain in the certificate is valid; check the certificate authority's website.
Cannot use the Server Certificates that include more than three CA certificates.	Import certificate files in PKCS#12 format that contains one or two CA certificates, or convert each certificate to PRM format and import them again.
The certificate has expired. Check if the certificate is valid, or check the date and time on your printer.	Make sure the product time and date are set correctly and, if the certificate is out of date, obtain and import a new certificate.

Message	Solution
Private key is required.	<p>Do one of the following to pair a private key with the certificate:</p> <ul style="list-style-type: none"> • For PEM/DER format certificates obtained from a CSR using a computer, specify the private key file. • For PKCS#12 format certificates obtained from a CSR using a computer, create a file containing the private key. <p>If you re-imported a PEM/DER format certificate obtained from a CSR using Web Config, you can only import it once. You must obtain and import a new certificate.</p>
Setup failed.	Make sure the computer and product are connected, and the certificate file is not corrupted, then import the certificate file again.

Parent topic: [Solving Network Security Problems](#)

Related tasks

[Obtaining and Importing a CA-signed Certificate](#)

[Selecting the Date and Time](#)

[Synchronizing the Date and Time with a Time Server](#)

Solving Copying Problems

Check these solutions if you have problems copying with your product.

[Product Makes Noise, But Nothing Copies](#)

[Product Makes Noise When It Sits for a While](#)

Parent topic: [Solving Problems](#)

Product Makes Noise, But Nothing Copies

If your product makes a noise, but nothing copies, try these solutions:

- Run a nozzle check to see if any of the print head nozzles are clogged. Then clean the print head, if necessary.

- If the nozzle check page does not print, but the product's power is on, make sure your product software is installed correctly.
- Make sure your product is level (not tilted).

Parent topic: [Solving Copying Problems](#)

Related concepts

[Print Head Nozzle Check](#)

[Uninstall Your Product Software](#)

Product Makes Noise When It Sits for a While

Your product is performing routine maintenance. This is normal.

Parent topic: [Solving Copying Problems](#)

Solving Copy Quality Problems

Check these sections if your copies have a quality problem.

[Copies Have Incorrect or Faint Colors](#)

[Position, Size, or Margins of Copies are Incorrect](#)

Parent topic: [Solving Problems](#)

Copies Have Incorrect or Faint Colors

If your copies have incorrect, uneven, smeared, or faint colors, try these solutions:

- Run a print head nozzle check to see if any of the nozzles are clogged. Then clean the print head, if necessary.
- Do not press too hard on the original when you copy from the scanner glass.
- Clean the scanner glass with a soft, dry, lint-free cloth or use a small amount of glass cleaner on the cloth, if necessary. Paper towels are not recommended.

Caution: Do not spray glass cleaner directly on the scanner glass.

- Make sure your paper is not curled.
- When copying on thick paper, select a **Thick Paper** setting from the control panel (**Settings > General Settings > Printer Settings > Thick Paper**). When this setting is enabled, copy quality may decline and copy speed may decrease.

- If the back of the original appears in your printout, place a piece of black paper on the back of the original and copy it again. You can also try lowering the **Density** setting.

Parent topic: [Solving Copy Quality Problems](#)

Related concepts

[Print Head Nozzle Check](#)

Related tasks

[Cleaning the Scanner Glass](#)

[Cleaning the Automatic Document Feeder](#)

[Loading Paper in the Paper Cassettes and Rear Paper Tray](#)

Position, Size, or Margins of Copies are Incorrect

If the position, size, or margins of your copies are incorrect, try these solutions:

- When placing originals in the ADF, make sure the edge guides are against the edges of the paper.
- When placing originals on the scanner glass, make sure the original is placed correctly for scanning. Align the corner of the original with the corner indicated by the symbol on the scanner glass. If necessary, move the original away from the edges of the scanner glass slightly.
- If the original is folded or wrinkled, use the scanner glass. Flatten any folds or wrinkles in the original and try using another sheet or card to keep the original in contact with the scanner glass.
- Clean the scanner glass and ADF.
- Make sure the paper is loaded in the correct direction.
- Select the appropriate copy size and paper size settings on the LCD screen.

Parent topic: [Solving Copy Quality Problems](#)

Related tasks

[Placing Originals on the Scanner Glass](#)

[Cleaning the Scanner Glass](#)

[Cleaning the Automatic Document Feeder](#)

[Copying Documents or Photos](#)

Solving Paper Problems

Check these sections if you have problems using paper with your product.

[Paper Feeding Problems](#)

[Originals Do Not Feed From the Automatic Document Feeder](#)

[Paper Jams Inside the Product](#)

[Paper Ejection Problems](#)

Parent topic: [Solving Problems](#)

Paper Feeding Problems

If you have problems feeding paper, try these solutions:

- If paper does not feed for printing, remove it from the paper tray or cassette. Reload it, then adjust the edge guides. Make sure the paper stack is not above the tab on the edge guides inside the cassette or paper tray.
- Be sure to insert the paper cassette all the way into your product.
- If multiple pages feed at once, remove the paper, fan the edges to separate the sheets, and reload it.
- Do not load more than the recommended number of sheets. For plain paper, do not load paper above the arrow mark on the edge guides.
- Make sure your paper meets the specifications for your product.
- If paper jams when you print on both sides of the paper, try loading fewer sheets.
- Run the paper guide cleaning utility to clean the paper roller.
- If you installed an optional paper cassette unit, be sure to enable the cassette unit in the printing software.
- For best results, follow these guidelines:
 - Use new, smooth, high-quality paper that is not curled, creased, old, too thin, or too thick.
 - Load paper in the cassette printable side down.
 - Load paper in the paper tray printable side up.
 - Do not load binder paper with holes in the cassette.
 - Follow any special loading instructions that came with the paper.

Parent topic: [Solving Paper Problems](#)

Related references

[Paper Specifications](#)

Related tasks

[Loading Paper in the Paper Cassettes and Rear Paper Tray](#)

[Cleaning the Paper Guide](#)

[Enabling the Optional Paper Cassettes - Windows](#)

[Enabling the Optional Paper Cassettes - PostScript Printer Software - Windows](#)

[Enabling the Optional Paper Cassettes - Mac](#)

[Enabling the Optional Paper Cassettes - PostScript Printer Software - Mac](#)

Originals Do Not Feed From the Automatic Document Feeder

If your originals do not feed when placed in the ADF, try these solutions:

- Make sure the **ADF** icon lights up on the Copy, Fax, or Scan screen on the LCD screen. If not, reload the originals.
- Make sure the size, weight, and number of your originals are supported by the ADF.
- Make sure the originals are loaded correctly.
- Slide the edge guides against the edges of the originals.
- Make sure the document is not curled or creased.
- Try cleaning the inside of the ADF.
- Do not load originals above the arrow mark on the ADF edge guide.

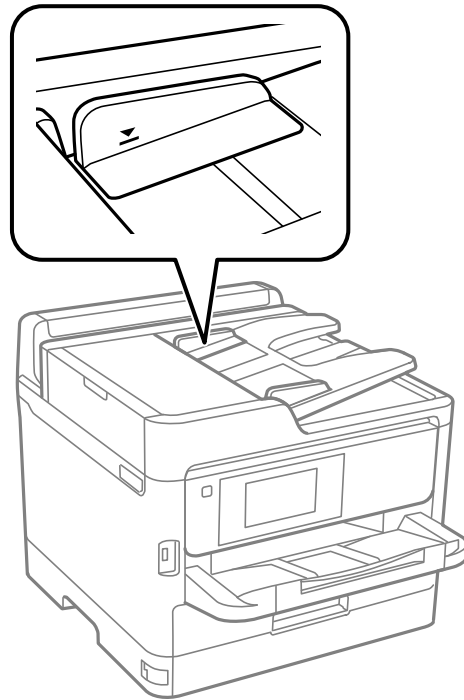

Parent topic: [Solving Paper Problems](#)

Related references

[Automatic Document Feeder \(ADF\) Specifications](#)

Related tasks

[Placing Originals in the Automatic Document Feeder](#)

Paper Jams Inside the Product

If you see a message that paper has jammed in the product, follow the on-screen instructions to locate and remove the jammed paper.

Take the following precautions when removing jammed paper from the product:

- Remove the jammed paper carefully. Using too much force may damage the product.
- Unless specifically instructed, avoid tilting the product, placing it on its side, or turning it upside down, as ink may spill.

Warning: Never touch the buttons on the control panel while your hand is inside the product. If the product starts operating, it may cause an injury. Do not touch any protruding parts inside the product.

Parent topic: [Solving Paper Problems](#)

Paper Ejection Problems

If you have problems with paper ejecting properly, try these solutions:

- If paper does not eject fully, you may have set the wrong paper size. Cancel printing to eject the paper. Select the correct paper size when you reprint.
- If paper is wrinkled when it ejects, it may be damp or too thin. Load new paper and be sure to select the correct paper type setting when you reprint.
- Clean the roller inside the printer to remove any dust on the paper path.

Parent topic: [Solving Paper Problems](#)

Related tasks

[Cleaning the Paper Guide](#)

[Selecting the Paper Settings for Each Source - Control Panel](#)

Solving Problems Printing from a Computer

Check these sections if you have problems while printing from your computer.

Note: When printing using AirPrint, the available print settings are different from those covered in this manual. See the Apple website for details.

Note: For problems while printing with the Epson Universal Print Driver or PostScript (PS3) printer software, see the sections covering that software in this manual.

[Nothing Prints](#)

[Product Icon Does Not Appear in Windows Taskbar](#)



[Printing is Slow](#)

Parent topic: [Solving Problems](#)

Nothing Prints

If you have sent a print job and nothing prints, try these solutions:

- Make sure your product is turned on and connected to your computer.
- Make sure any interface cables are connected securely at both ends.
- Make sure the interface specifications match the specifications for the printer and the computer.
- Make sure there are no errors or paper jams in the product.
- If you connected your product to a USB hub, make sure it is a first-tier hub. If it still does not print, connect your product directly to your computer instead of the hub.
- If your computer is connected using a USB cable, try a different USB port on your computer or a different cable.
- Make sure the printer status is not offline or pending.
- Run a product check to see if a test page prints. If the test page prints, check to see if your product software is installed correctly.
- Make sure your system meets the requirements for your operating system. If you are printing a high-resolution image, you may need more than the minimum requirements. Print the image at a lower resolution or if necessary, increase your system's memory.
- In Windows, make sure your product is selected as the default printer and the printer port setting matches the printer connection port.
- In Windows, delete all jobs from the Windows Spooler. Click **Print Queue** on the Maintenance tab in the printer settings window, and cancel any stalled print jobs.

- In Windows, do one of the following to open the Epson Printer Connection Checker and follow the on-screen instructions to check the connection status:
 - **Windows 11:** Click , then search for **Epson Printer Connection Checker** and select it.
 - **Windows 10:** Click  and select **Epson Software > Epson Printer Connection Checker**.
 - **Windows 8.x:** Navigate to the **Apps** screen and select the **Epson Printer Connection Checker** icon.
 - **Windows 7:** Click  and select **All Programs > Epson Software > Epson Printer Connection Checker**.
- On a Mac, make sure the printer is added to the printer list and the printer is not paused.
- If you are using the PostScript printing software, make sure the printing language setting on the control panel is set to **Auto** or **PS**.
- Make sure your product is selected as the printer in your printing program.
- In Windows, the product may not print if a large number of print jobs are sent. Try selecting **Print directly to the printer** on the Advanced tab in the printer properties.
- You can try to clear the problem by updating the product software to the latest version. If the problem persists, try uninstalling and reinstalling the printer driver.

Parent topic: [Solving Problems Printing from a Computer](#)

Related references

[Interface Specifications](#)

[Windows System Requirements](#)

[Mac System Requirements](#)

Related tasks





[Running a Product Check](#)

Product Icon Does Not Appear in Windows Taskbar

If you do not see your product icon in the Windows taskbar, first try restarting your computer. If that does not work, try this solution:

1. Do one of the following:

- **Windows 11:** Click , search for **Settings** and select it. Select **Bluetooth & devices > Printers & scanners**. Select your product name and select **Printing preferences**.

- **Windows 10:** Click  and select  (Settings) > **Devices** > **Printers & scanners**. Select your product name and select **Manage** > **Printing preferences**.
 - **Windows 8.x:** Navigate to the **Apps** screen and select **Control Panel** > **Hardware and Sound** > **Devices and Printers**. Right-click your product name, select **Printing Preferences**, and select your product name again if necessary.
 - **Windows 7:** Click  and select **Devices and Printers**. Right-click your product name, select **Printing Preferences**, and select your product name again if necessary.
 - **Windows Vista:** Click , select **Control Panel**, and click **Printer** under **Hardware and Sound**. Right-click your product name, select **Printing Preferences**, and select your product name again if necessary.
2. Click the **Maintenance** tab.
 3. Click the **Extended Settings** button.
 4. Select **Enable EPSON Status Monitor 3** and click **OK**.
 5. Click the **Monitoring Preferences** button.
 6. Click the checkbox for the option that adds the shortcut icon to the taskbar.
 7. Click **OK** to close the open program windows.

Parent topic: [Solving Problems Printing from a Computer](#)

Printing is Slow

If printing becomes slow, try these solutions:

- Make sure your system meets the requirements for your operating system. If you are printing a high-resolution image, you may need more than the minimum requirements. If necessary, increase your system's memory.
- If you are using Windows 7, close the **Devices and Printers** window before you print.
- Make sure **Quiet Mode** is turned off.
- Clear space on your hard drive or run a defragmentation utility to free up existing space.
- Close any programs you are not using when you print.
- If your product is connected to a USB hub, connect it directly to your computer instead.
- If printing becomes slower after printing continuously for a long time, the product may have automatically slowed down to protect the print mechanism from overheating or becoming damaged. Let the product rest with the power on for 30 minutes, then try printing again.

- If you are printing over a wireless network, factors such as interference, network traffic, or weak signal strength may affect your printing speed.

Note for Latin America: If you are using a 5 GHz wireless router, set the router to operate in dual band (2.4 GHz and 5 GHz) mode. If your router uses a single network name (SSID) for both the 2.4 GHz and 5 GHz band, give each band its own network name (SSID) instead, such as Home Network 2.4 GHz and Home Network 5 GHz. See your router documentation or contact your internet service provider for instructions.

- If you are using the Windows PostScript printer software, try selecting **Fast** as the **Print Quality** setting on the Advanced tab of the printer software.

For the fastest printing, select the following settings in your product software:

- Turn on any high speed settings in your product software.
- Select a lower print quality setting.
- Make sure the ink drying time has not been increased for double-sided printing.
- **Windows:** Click the **Maintenance** or **Utility** tab, select **Extended Settings** or **Speed and Progress**, and select the following settings:
 - **Always Spool RAW Datatype**
 - **Page Rendering Mode**
 - **Print as Bitmap**
- **Windows:** Select **Printing preferences**, click the **More Options** tab, and make sure the **Bidirectional printing** setting is enabled.
- **Mac:** Select **System Preferences** or **System Settings**, select **Printers & Scanners**, and select your product. Select **Options & Supplies**, select **Options** (or **Driver**), and enable the **Bidirectional printing** setting.
- Enable the bidirectional setting on the product control panel (**Settings > General Settings > Printer Settings > Bidirectional**).

If printing is still slow and you are using Windows 7 or Windows Vista, try the following:

1. Click  and select **Computer** or **My Computer**. Double-click the **C:** drive and open these folders: **ProgramData > EPSON > PRINTER**.

Note: If you do not see the ProgramData folder, open the **Organize** menu and select **Folder and search options**. In the window that appears, click the **View** tab, select **Show hidden files, folders, and drives** in the Advanced settings list, and click **OK**.

2. Right-click the **EPAUDF01.AUD** file and select **Delete**.
3. Restart your computer and try printing again.

Parent topic: [Solving Problems Printing from a Computer](#)

Related references

[Windows System Requirements](#)

[Mac System Requirements](#)

Solving Page Layout and Content Problems

Check these sections if you have problems with the layout or content of your printed pages.

Note: When printing using AirPrint, the available print settings are different from those covered in this manual. See the Apple website for details.

[Inverted Image](#)

[Too Many Copies Print](#)

[Blank Pages Print](#)

[Incorrect Margins on Printout](#)

[Incorrect Characters Print](#)

[Incorrect Image Size or Position](#)

[Slanted Printout](#)

Parent topic: [Solving Problems](#)

Inverted Image

If your printed image is inverted unexpectedly, try these solutions:

- Turn off any mirror or inversion settings in your printing application.
- Turn off the **Mirror Image**, **Flip horizontally**, or **Reverse page orientation** settings in your printer software. (This option has different names, depending on your operating system version.)

Parent topic: [Solving Page Layout and Content Problems](#)

Related tasks

[Selecting Additional Layout and Print Options - Windows](#)

[Selecting Print Layout Options - Mac](#)

Too Many Copies Print

Make sure that the **Copies** setting in your printing program or printer software is not set for multiple copies.

Parent topic: [Solving Page Layout and Content Problems](#)

Blank Pages Print

If blank pages print unexpectedly, try these solutions:

- Make sure you selected the correct paper size settings in your printing program and printer software.
- If a blank page exists in a document you are printing and you want to skip printing it, select the **Skip Blank Page** setting in your printer software, if available.
- Run a print head nozzle check to see if any of the nozzles are clogged. Then clean the print head, if necessary.
- Make sure your product is selected as the printer in your printing program.
- Make sure your product is on a flat surface and operating in the recommended environmental conditions or multiple sheets of paper may be fed at the same time.

Parent topic: [Solving Page Layout and Content Problems](#)

Related concepts

[Print Head Nozzle Check](#)

[Print Head Cleaning](#)

Related references

[Environmental Specifications](#)

Related tasks

[Selecting Extended Settings - Windows](#)

[Selecting Printing Preferences - Mac](#)

Incorrect Margins on Printout

If your printed page has incorrect margins, try these solutions:

- Make sure you selected the correct paper size settings in your printing program and printer software.
- Make sure you selected the correct margins for your paper size in your printing program.
- Make sure your paper is positioned correctly for feeding into the product.

- When placing originals on the scanner glass, align the corner of the original with the corner indicated by the arrow. If the edges of the copy are cropped, move the original slightly away from the corner.
- Clean the scanner glass and the document cover. If there is dust or stains on the glass, the copy area may extend to include the dust or stains.
- Load paper in the correct direction and slide the edge guides against the edges of the paper.
- Select the appropriate original size in the copy settings.

You can use the preview option in your printer software to check your margins before you print.

Parent topic: [Solving Page Layout and Content Problems](#)

Related tasks

[Selecting Basic Print Settings - Windows](#)

[Selecting Basic Print Settings - Mac](#)

[Selecting Basic Print Settings - PCL Driver - Windows](#)

[Selecting Print Settings - PostScript Printer Software - Windows](#)

[Loading Paper in the Paper Cassettes and Rear Paper Tray](#)

Incorrect Characters Print

If incorrect characters appear in your prints, try these solutions before reprinting:

- Make sure any cables are securely connected at both ends.
- In Windows, delete all jobs from the Windows Spooler. Click **Print Queue** on the Maintenance tab in the printer settings window, and cancel any stalled print jobs.
- On a Mac, cancel any paused print jobs.
- If your product is connected to a USB hub, connect it directly to your computer instead.
- If incorrect characters still appear in your prints, try connecting your product using a different cable.
- If your computer entered sleep mode the last time you printed, the next print job after your computer exits sleep mode may contain garbled characters. Print your document again.
- If you are using the PostScript printer software, EPS files created in binary format may not print correctly. Try creating the file in ASCII format instead.
- If you are using the Windows PostScript printer software, the product cannot print binary data if it is connected to the computer using a USB cable. Try selecting **ASCII** or **TBCP** as the **Output Protocol** setting on the Device Settings tab in the printer properties.
- If you are using the Windows PostScript printer software, select the appropriate substitution fonts on the Device Settings tab in the printer properties.

Parent topic: [Solving Page Layout and Content Problems](#)

Related tasks

[Selecting Basic Print Settings - PCL Driver - Windows](#)

[Selecting Print Settings - PostScript Printer Software - Windows](#)

Incorrect Image Size or Position

If your printed image is the wrong size or in the wrong position, try these solutions:

- Make sure you selected the correct paper size and layout settings in your printing program and printer software.
- Make sure you selected the correct paper size on the control panel.
- Make sure your paper is positioned correctly for feeding into the printer.
- If the edges of a copy are cropped, slightly move the original away from the edges of the scanner glass.
- Make sure you selected the correct margins for your paper size in your printing program.
- Be sure to select the appropriate original size setting for your original in the copy settings.

You can use the preview option in your printer software to check your margins before you print.

Parent topic: [Solving Page Layout and Content Problems](#)

Related references

[Copying Options](#)

Related tasks

[Selecting Basic Print Settings - Windows](#)

[Selecting Basic Print Settings - Mac](#)

[Loading Paper in the Paper Cassettes and Rear Paper Tray](#)

[Placing Originals on the Scanner Glass](#)

Slanted Printout

If your printouts are slanted, try these solutions:

- Make sure the paper is loaded in the correct direction.
- Make sure your paper meets the specifications for your product.
- Slide the edge guides against the edges of the paper.
- Make sure the paper type setting matches the type of paper you loaded.

- Select a higher print quality setting in your printer software.
- Turn off any high speed settings in your product software.
- Align the print head.
- Adjust the print quality.
- If aligning the print head did not improve the quality, disable the **Bidirectional Printing** setting.
- Make sure the product is not printing while tilted or at an angle.

Parent topic: [Solving Page Layout and Content Problems](#)

Related references

[Paper Specifications](#)

[Paper or Media Type Settings - Printing Software](#)

Related tasks

[Selecting Basic Print Settings - Windows](#)

[Selecting Basic Print Settings - Mac](#)

[Loading Paper in the Paper Cassettes and Rear Paper Tray](#)

[Selecting the Paper Settings for Each Source - Control Panel](#)

[Aligning the Print Head Using the Product Control Panel](#)

[Adjusting the Print Quality Using the Product Control Panel](#)

Solving Print Quality Problems

Check these sections if your printouts have problems with print quality, but your image looks fine on your computer screen.

Note: When printing using AirPrint, the available print settings are different from those covered in this manual. See the Apple website for details.

[White or Dark Lines in Printout](#)

[Blurry or Smearred Printout](#)

[Faint Printout or Printout Has Gaps](#)

[Grainy Printout](#)

[Incorrect Colors](#)

Parent topic: [Solving Problems](#)

White or Dark Lines in Printout

If you notice white or dark lines in your prints (also called banding), try these solutions before you reprint:

- Run a nozzle check to see if any of the print head nozzles are clogged. Then clean the print head, if necessary.
- Make sure the paper type setting matches the type of paper you loaded.
- Make sure you loaded the printable side of the paper correctly for your product.
- Turn off any high speed settings in your product software.
- Align the print head. If print quality does not improve after aligning the print head, disable the bidirectional (high speed) setting.
- If you are copying from the ADF, copy from the scanner glass instead or use a higher quality setting.
- When vertical banding appears or the paper is smeared, clean the paper path.
- You may need to replace an ink pack.

Parent topic: [Solving Print Quality Problems](#)

Related concepts

[Print Head Nozzle Check](#)

[Print Head Cleaning](#)

Related references

[Paper or Media Type Settings - Printing Software](#)

Related tasks

[Selecting the Paper Settings for Each Source - Control Panel](#)

[Aligning the Print Head Using the Product Control Panel](#)

[Placing Originals on the Scanner Glass](#)

[Cleaning the Paper Guide](#)

[Removing and Installing Ink Packs](#)

Blurry or Smeared Printout

If your printouts are blurry or smeared, try these solutions:

- Make sure your paper is not damp, curled, old, or loaded incorrectly in your product.
- Slide the edge guides to the edges of the paper.
- Use a support sheet with special paper, or load special paper one sheet at a time.

- Make sure your paper meets the specifications for your product.
- Use Epson papers to ensure proper saturation and absorption of genuine Epson inks.
- Make sure the paper type setting in your product software matches the type of paper you loaded.
- Make sure you loaded the printable side of the paper correctly for your product.
- If you are printing on thick paper or envelopes, turn on the **Thick Paper** setting from the control panel or select **Thick Paper and Envelopes** in the Extended Settings of the printer software. (Turning this setting on will decrease print speed.)
- When manually printing 2-sided, make sure the ink is completely dry before loading the paper.
- Remove each sheet from the output tray as it is printed.
- Avoid handling printouts on glossy paper right after printing to allow the ink to set.
- Turn off any high speed settings in your product software.
- When vertical banding appears or the paper is smeared, clean the paper path.
- If you print on both sides of a sheet of paper, smudges may appear on the reverse side of heavily saturated or dark images. If one side of a sheet will contain a lighter image or text, print that side first. Adjust the density and/or ink drying time settings.
- Lower the copy density setting on the product control panel.
- Run a nozzle check to see if any of the print head nozzles are clogged. Then clean the print head, if necessary.
- Align the print head.
- Align the print head using the **Print Quality Adjustment** setting.
- Clean the paper path.
- Do not press too hard on the original or the document cover when you are scanning originals on the scanner glass.
- Clean the scanner glass.
- Clean the ADF.

Note: Your product will not operate properly while tilted at an angle. Place it on a flat, stable surface that extends beyond the base of the product in all directions.

Parent topic: [Solving Print Quality Problems](#)

Related references

[Paper Specifications](#)

[Compatible Epson Papers](#)

[Paper or Media Type Settings - Printing Software](#)

Related tasks

[Loading Paper in the Paper Cassettes and Rear Paper Tray](#)

[Selecting the Paper Settings for Each Source - Control Panel](#)

[Cleaning the Paper Guide](#)

[Cleaning the Scanner Glass](#)

[Cleaning the Automatic Document Feeder](#)

Faint Printout or Printout Has Gaps

If your printouts are faint or have gaps, try these solutions:

- Run a nozzle check to see if any of the print head nozzles are clogged. Then clean the print head, if necessary.
- The ink packs may be old or low on ink, and you may need to replace them.
- Make sure the paper type setting matches the type of paper you loaded.
- Make sure your paper is not damp, curled, old, or loaded incorrectly in your product.
- When copying, increase the **Density** setting on the product control panel.
- Align the print head.
- Adjust the print quality in the product software.
- Clean the paper path.

Parent topic: [Solving Print Quality Problems](#)

Related concepts

[Print Head Nozzle Check](#)

Related tasks

[Removing and Installing Ink Packs](#)

[Selecting Basic Print Settings - Windows](#)

[Selecting Basic Print Settings - Mac](#)

[Aligning the Print Head Using the Product Control Panel](#)

[Adjusting the Print Quality Using the Product Control Panel](#)

Grainy Printout

If your printouts are grainy, try these solutions:

- Make sure you loaded the printable side of the paper correctly for your product.
- Select a higher print quality setting and turn off any high speed settings in your product software.
- Run a nozzle check to see if any of the print head nozzles are clogged. Then clean the print head, if necessary.
- Align the print head.
- Align the print head using the **Print Quality Adjustment** setting.
- Adjust the print quality in the product software.
- You may need to increase the image resolution or print a smaller size; see your software documentation.

Note: Images from the Internet may be low resolution and not result in a high quality printout.

- If you enlarged the image size in an image-editing program, you need to increase the image resolution setting to retain a high image quality. Increase the image resolution by the same amount you increase the image size. For example, if the image resolution is 300 dpi (dots per inch) and you will double the image size for printing, change the resolution setting to 600 dpi.

Note: Higher resolution settings result in larger file sizes, which take longer to process and print. Consider the limitations of your computer system when selecting a resolution, and select the lowest possible resolution that produces acceptable quality to keep file sizes manageable.

Parent topic: [Solving Print Quality Problems](#)

Related concepts

[Print Head Nozzle Check](#)

Related tasks

[Removing and Installing Ink Packs](#)

[Selecting Basic Print Settings - Windows](#)

[Selecting Basic Print Settings - Mac](#)

[Aligning the Print Head Using the Product Control Panel](#)

[Adjusting the Print Quality Using the Product Control Panel](#)

Incorrect Colors

If your printouts have incorrect colors, try these solutions:

- Make sure the paper type setting matches the paper you loaded.
- Make sure the **Grayscale** setting is not selected in your printer software.
- Run a nozzle check to see if any of the print head nozzles are clogged. Then clean the print head, if necessary.
- After you print, the colors in your printout need time to set as the ink dries. During this time, the colors may look different than you expect. To speed up drying time, do not stack your printouts on top of each other.
- Your printed colors can never exactly match your on-screen colors. However, you can use a color management system to get as close as possible. Try using the color management options in your printer software.
- Try turning off the **PhotoEnhance** setting in Windows.
- Select **Custom** as the **Color Correction** setting on the More Options tab of the printer software, then click **Advanced**. Try changing the **Scene Correction** setting to something other than **Automatic**. If changing that setting does not work, change the **Color Management** setting to any color correction method other than **PhotoEnhance**.
- If you are using the Windows PostScript printer software, try adjusting the **Color Mode** setting on the Advanced tab of the printer software.
- For best results, use genuine Epson paper.
- Remove any dust or dirt on the originals and clean the scanner glass.
- Do not press with too much force on the original or the document cover.
- On the product control panel, change the **Fix Photo** setting from **Auto** to another option, or select **Enhance Off**.
- If you are copying an original, lower the **Density** setting.

Parent topic: [Solving Print Quality Problems](#)

Related references

[Compatible Epson Papers](#)

Related tasks

[Selecting Additional Layout and Print Options - Windows](#)

[Selecting Basic Print Settings - Mac](#)
[Cleaning the Scanner Glass](#)

Solving Scanning Problems

Check these solutions if you have problems scanning with your product.

Note: For solutions when using the Epson ScanSmart software, see the Epson ScanSmart help utility.

[Scanning Software Does Not Operate Correctly](#)
[Cannot Start Epson Scan 2](#)

Parent topic: [Solving Problems](#)

Scanning Software Does Not Operate Correctly

If your scanning software does not operate correctly, try these solutions:

- Make sure your computer has adequate memory and meets the system requirements for your operating system.
- Make sure your computer is not running in a power-saving mode, such as sleep or standby. If so, wake your system and restart your scanning software.
- If you upgraded your operating system but did not reinstall your scanning software, try reinstalling it.
- In Windows, make sure your product is listed as a valid device in the **Scanners and Cameras** control panel.

Parent topic: [Solving Scanning Problems](#)

Cannot Start Epson Scan 2

If you cannot start Epson Scan 2, try these solutions:

- Make sure your product is turned on and any interface cables are securely connected at both ends.
- If your product is connected to a USB hub, connect it directly to your computer instead.
- Make sure Epson Scan 2 is selected as your scanning program.
- Make sure your computer is not running in a power-saving mode, such as sleep or standby. If so, wake your system and restart Epson Scan 2.
- Check the connection setting and test the connection using Epson Scan 2 Utility:

Windows 11: Click , search for **Epson Scan 2 Utility** and select it. Make sure the correct product is selected. If necessary, select the **Other** tab and click **Reset**.

Windows 10: Click  and select **EPSON > Epson Scan 2 Utility**. Make sure the correct product is selected. If necessary, select the **Other** tab and click **Reset**.

Windows 8.x: Navigate to the **Apps** screen and select **Epson Scan 2 Utility**. Make sure the correct product is selected. If necessary, select the **Other** tab and click **Reset**.

Windows (other versions): Click  or **Start > All Programs** or **Programs > EPSON > Epson Scan 2 > Epson Scan 2 Utility**. Make sure the correct product is selected. If necessary, select the **Other** tab and click **Reset**.

Mac: Open the **Applications** folder, click **Epson Software**, and click **Epson Scan 2 Utility**. Make sure the correct product is selected. If necessary, select the **Other** tab and click **Reset**.

- Make sure you do not have multiple versions of Epson Scan 2 installed. If you do, uninstall both versions and install one version.
- If you upgraded your operating system but did not reinstall Epson Scan 2, try reinstalling it.
- If the user restriction feature (Access Control) is enabled, a user ID and password are required to scan. If you do not know the user ID or password, contact your administrator for assistance.

Parent topic: [Solving Scanning Problems](#)

Related tasks

[Starting a Scan Using the Epson Scan 2 Icon](#)

[Checking for Software Updates](#)

Solving Scanned Image Quality Problems

Check these sections if a scanned image on your computer screen has a quality problem.

Note: For solutions when using Document Capture Pro (Windows) or Document Capture (Mac) software, see the Document Capture Pro (Windows) or Document Capture (Mac) help utility.

[Image Consists of a Few Dots Only](#)

[Line of Dots Appears in All Scanned Images](#)

[Straight Lines in an Image Appear Crooked](#)

[Scanned Image Quality Problems](#)

[Image Colors are Patchy at the Edges](#)

[Ripple Patterns Appear in an Image](#)

[Scanned Image Edges are Cropped](#)

Parent topic: [Solving Problems](#)

Image Consists of a Few Dots Only

If your scanned image consists only of a few dots, try these solutions:

- Make sure you placed your original for scanning facing the correct way.
- Remove any lint or dirt from your original.
- Clean the scanner glass.
- Do not press on the original or the document cover with too much force.

Parent topic: [Solving Scanned Image Quality Problems](#)

Related tasks

[Cleaning the Scanner Glass](#)

Line of Dots Appears in All Scanned Images

If a line of dots appears in all your scanned images, try these solutions:

- Clean the scanner glass with a soft, dry, lint-free cloth or use a small amount of glass cleaner on the cloth, if necessary. Paper towels are not recommended.

Caution: Do not spray glass cleaner directly on the scanner glass.

- Make sure any interface cables are securely connected at both ends.
- Remove any dust or dirt that may have adhered to your original.
- Do not press with too much force on the original or the document cover.

If you are scanning from the ADF, make sure the ADF edge guides fit against the loaded originals. You can also try cleaning the ADF and scanning again.

Parent topic: [Solving Scanned Image Quality Problems](#)

Related tasks

[Cleaning the Scanner Glass](#)

[Cleaning the Automatic Document Feeder](#)

Straight Lines in an Image Appear Crooked

If straight lines in an original appear crooked in a scanned image, make sure to place your original straight when you scan it.

Clean the scanner glass with a soft, dry, lint-free cloth or use a small amount of glass cleaner on the cloth, if necessary. Paper towels are not recommended.

If you are scanning from the ADF, make sure the ADF edge guides fit against the loaded originals. You can also try cleaning the ADF and scanning again.

Parent topic: [Solving Scanned Image Quality Problems](#)

Related tasks

[Cleaning the Scanner Glass](#)

[Cleaning the Automatic Document Feeder](#)

Related topics

[Placing Originals on the Product](#)

Scanned Image Quality Problems

If you encounter quality problems with your scanned image, try these solutions:

Image is Distorted or Blurry

- Do not move your original or your product during scanning.
- Your product will not operate properly while tilted at an angle. Place your product on a flat, stable surface that extends beyond its base in all directions.
- Adjust these Epson Scan 2 settings (if available) and try scanning again:
 - Make sure you select the correct **Image Type** for your original.
 - Increase the **Resolution** setting.
 - If the **Image Type** setting is **Black & White**, adjust the **Threshold** setting. (The **Image Option** must be set to **None** or **Color Enhance**.)
 - If the **Image Type** setting is **Color** or **Grayscale**, select the **Unsharp Mask** setting.
 - If the **Image Type** setting is **Black & White**, select **Text Enhancement**. If the **Image Type** setting is **Color** or **Grayscale**, change the **Text Enhancement** setting to **High**.

Image is Too Dark

- Make sure you select the correct **Image Type** for your original.

- If the **Image Type** is set to **Color** or **Grayscale**, adjust the **Brightness** setting.
- Check the brightness and contrast settings of your computer monitor.

Back of Original Image Appears in Scanned Image

- Place a piece of black paper on the back of the original and scan it again.
- Lower the copy density setting.
- Adjust these Epson Scan 2 settings (if available) and try scanning again:
 - Select the **Advanced Settings** tab and adjust the **Brightness** setting.
 - If the **Image Type** is set to **Black & White**, select **Text Enhancement**. If the **Image Type** is set to **Color** or **Grayscale**, change the **Text Enhancement** setting to **High**.

Scanned Image Colors Do Not Match Original Colors

Printed colors can never exactly match the colors on your computer monitor because printers and monitors use different color systems: monitors use RGB (red, green, and blue) and printers typically use CMYK (cyan, magenta, yellow, and black).

Check the color matching and color management capabilities of your computer, display adapter, and the software you are using to see if they are affecting the palette of colors you see on your screen.

Remove any dust or dirt from your originals and clean the scanner glass. Do not press with too much force on the original or document cover.

To adjust the colors in your scanned image, adjust these Epson Scan 2 settings (if available) and try scanning again:

- Make sure you select the correct **Image Type** for your original.
- If the **Image Type** setting is **Auto**, **Color** or **Grayscale**, adjust the **Contrast** setting.
- If the **Image Type** setting is **Black & White** or **Grayscale**, adjust the **Color Enhance** setting.

Parent topic: [Solving Scanned Image Quality Problems](#)

Related references

[Control Panel Scanning Options](#)

Related tasks

[Cleaning the Scanner Glass](#)

[Cleaning the Automatic Document Feeder](#)

Related topics

[Placing Originals on the Product](#)

Image Colors are Patchy at the Edges

If you are scanning a thick or warped original, cover its edges with paper to block external light as you scan it.

Parent topic: [Solving Scanned Image Quality Problems](#)

Ripple Patterns Appear in an Image

You may see a ripple pattern (called a moiré) in scanned images of printed documents. This is caused by interference from differing pitches in the scanner's screen and your original's halftone screen. To reduce this effect, adjust these Epson Scan 2 settings (if available) and try scanning again:

- Select the **Descreening** setting on the Advanced Settings tab.
- Select a lower **Resolution** setting.
- Place the original at a slightly different angle.

Parent topic: [Solving Scanned Image Quality Problems](#)

Related references

[Additional Scanning Settings - Advanced Settings Tab](#)

[Additional Scanning Settings - Main Settings Tab](#)

Scanned Image Edges are Cropped

If the edges of a scanned image are cropped, make sure your original is placed correctly for scanning. If necessary, move your original away from the edges of the scanner glass slightly.

In the Epson Scan 2 settings, set the **Edge Fill** setting to **None**.

Parent topic: [Solving Scanned Image Quality Problems](#)

Related references

[Additional Scanning Settings - Advanced Settings Tab](#)

Related topics

[Placing Originals on the Product](#)

Solving Faxing Problems

Check these solutions if you have problems faxing with your product.

[Cannot Send or Receive Faxes](#)

[Cannot Receive Faxes with a Telephone Connected to Your Product](#)

[Fax Memory Full Error Appears](#)
[Fax Quality is Poor](#)
[Sent Fax is Received in an Incorrect Size](#)
[Received Fax is Not Printed](#)

Parent topic: [Solving Problems](#)

Cannot Send or Receive Faxes

If you cannot send or receive faxes, try these solutions:

- If an error code is displayed on the control panel, try the solutions suggested in the error code list.
- Use **Check Fax Connection** on the control panel (**Settings > General Settings > Fax Settings > Check Fax Connection**) to run the automatic fax connection check. Try the solutions suggested in the report.
- If you are faxing from a computer, use the Epson FAX Utility to send your fax.
- Make sure the recipient's fax machine is turned on and working.
- Make sure the recipient's fax number is correct and entered correctly.
- Make sure paper is loaded correctly in your product.
- Make sure you have set up your header information and have not blocked your caller ID. Otherwise, your faxes might be rejected by the recipient's fax machine.
- Make sure Receive Mode is set to **Auto** so you can receive faxes automatically.
- Check that the cable connecting your telephone wall jack to your product's **LINE** port is secure.
- Print a fax connection report using your product control panel or fax software to help diagnose the problem.
- Verify that the telephone wall jack works by connecting a phone to it and testing it.
- Check the **Line Type** setting and set it to **PBX**. If your phone system requires an external access code to reach an outside line, register the code to the product and add a # (hash) to the beginning of the phone number when dialing.
- If you connected your product to a DSL phone line, you must connect a DSL filter to the phone jack to enable faxing over the line. Contact your DSL provider for the necessary filter.
- If you are connected to a DSL phone line, connect the product directly to a telephone wall jack and send a fax. If it works, the problem may be caused by the DSL filter. Contact your DSL provider.
- If your telephone line has static, turn off your product's error correction mode fax communication setting and try faxing again.

- Make sure you installed the FAX driver for your product and that it is not paused.
- The data being sent may be too large. Try faxing the originals in batches, by using a connected phone, or by selecting **On Hook**. If you are faxing in monochrome, enable the **Direct Send** setting (**Fax > Fax Settings > Fax Send Settings**).
- Try lowering your product's fax speed setting.
- If a communication error occurs, change the **Fax Speed** setting to **Slow(9,600bps)** on the control panel.
- Make sure the error correction mode (ECM) setting is turned on if you are trying to send or receive a color fax.
- If your telephone line uses call waiting and you have trouble receiving faxes, turn off call waiting to prevent disruption of incoming faxes.
- If you have subscribed to a call forwarding service, the product may not be able to receive faxes. Contact your service provider for assistance.
- If the recipient fax machine does not answer your call within 50 seconds after the product has finished dialing, add pauses after the fax number to send the fax.
- Check your inbox and delete faxes after reading or printing them. If the inbox is full, the product cannot receive faxes.
- When sending faxes using the subaddress feature, ask the recipient if their fax machine can receive faxes using this feature. Check that the subaddress and password are correct, and that they match with the recipient subaddress and password. Check this when receiving faxes as well.
- Check if the sender's fax number is registered to the **Rejection Number List**
- If you enabled **Rejection Fax** options, check if the sender is blocked, did not set up header information, or is not registered in your contacts list, as necessary.
- If you cannot send faxes at a specified time, make sure the date and time are set correctly on the product.
- If you have not connected a telephone to the printer, set the **Receive Mode** setting to **Auto** on the control panel.
- If you are receiving faxes using the Epson FAX Utility, check that your product is registered as a fax product in your operating system:

Windows: Make sure the product appears in **Devices and Printers**, **Printer**, or **Printers and Other Hardware**. If the product does not appear, uninstall and re-install the Epson FAX Utility.

Mac: Select **System Preferences** or **System Settings** > **Printers & Scanners** (or **Print & Scan** or **Print & Fax**) and make sure your product appears. If your product does not appear, click **+** and add your product. If the product does appear, double-click it and make sure it is not paused.

Note: Do not turn the product off while it is receiving a fax. Otherwise, the fax transmission will be lost.

Note: If your product is connected to a VoIP (Voice over Internet Protocol) phone line, keep in mind that fax machines are designed to work over analog phone lines. Epson cannot guarantee that fax transmission will work when using VoIP.

If your phone line includes voice mail answering services, calls or faxes may be inadvertently received by your voice mail service.

Parent topic: [Solving Faxing Problems](#)

Related references

[Basic Settings - Fax](#)

Related tasks

[Receiving Faxes Automatically](#)

[Connecting a Telephone or Answering Machine](#)

[Sending Faxes Using the Fax Utility - Windows](#)

[Sending Faxes Using the Fax Utility - Mac](#)

[Loading Paper in the Paper Cassettes and Rear Paper Tray](#)

[Printing Fax Reports](#)

[Sending a Fax at a Specified Time](#)

Cannot Receive Faxes with a Telephone Connected to Your Product

If you cannot receive faxes when a telephone is connected to your product, try these solutions:

- Make sure your telephone is connected to your product's **EXT** port.
- Make sure the Receive Mode is set to **Manual**.

Note: When answering a call that is a fax, wait until the product's LCD screen displays a message that a connection has been made before you hang up.

Parent topic: [Solving Faxing Problems](#)

Related tasks

- [Connecting a Telephone or Answering Machine](#)
- [Receiving Faxes Manually](#)

Fax Memory Full Error Appears

If you see an error message telling you that the product's fax memory is full, try these solutions:

- If you set the product to save received faxes in the product's memory or inbox, delete any faxes you have already read.

Note: Your product can store up to 200 faxes before its inbox is full.

- If you set the product to save received faxes on a computer, turn on the selected computer. Once the faxes are saved on the computer, they are deleted from the product's memory.
- If you set the product to save received faxes on a USB device, connect the selected USB device containing the save fax folder to the product. Once the faxes are saved on the USB device, they are deleted from the product's memory.

Note: Make sure the USB device has enough available memory and is not write protected.

- If the memory is full, try the following:
 - Send a monochrome fax using the direct sending feature
 - Send your fax using the on hook feature
 - Send your faxes in smaller batches
- If the product cannot print a received fax due to a product error, such as a paper jam, the memory full error may appear. Clear any product errors, then ask the sender to resend the fax.

Parent topic: [Solving Faxing Problems](#)

Related references

[Fax Sending Options](#)

Related tasks

[Forwarding Received Faxes](#)

Fax Quality is Poor

If you receive a poor quality fax, try these solutions:

- Try enabling the error correction mode (ECM) setting.
- Contact the fax sender and ask them to send the fax in a higher resolution.
- Try reprinting the received fax.

If the sent fax quality is poor, try these solutions:

- Clean the scanner glass.
- Clean the ADF.
- Try changing the resolution or density setting on the control panel.
- Do not press on the document cover or the original with too much force.
- Remove any dust or dirt from the originals.
- Try changing the original type setting on the control panel.
- If you are sending a monochrome fax to a single recipient, try sending the fax using the **Direct Send** feature.

Note: If you send a high-resolution monochrome fax without using the **Direct Send** feature, the product may automatically lower the resolution.

- Try enabling the error correction mode (ECM) setting.
- If the back of the original appears in your sent fax, place a piece of black paper on the back of the original and fax it again.

Parent topic: [Solving Faxing Problems](#)

Related references

[Basic Settings - Fax](#)

[Fax Sending Options](#)

Related tasks

[Cleaning the Scanner Glass](#)

[Cleaning the Automatic Document Feeder](#)

Sent Fax is Received in an Incorrect Size

If your recipient receives a fax in an incorrect size, try these solutions:

- Make sure the original is placed correctly against the alignment marks.
- If the edge of the scanned image is missing, move the original away from the edge of the scanner glass.
- Clean any dust or dirt from the originals.
- If you are sending a fax using the scanner glass, make sure your original is placed correctly and that the correct paper size is selected on the control panel.
- Clean the scanner glass and document cover.

Parent topic: [Solving Faxing Problems](#)

Related topics

[Placing Originals on the Product](#)

Received Fax is Not Printed

If a received fax is not printed, try these solutions:

- Make sure the product is free of errors. The product cannot print received faxes if an error has occurred with the product, such as a paper jam.
- If the product has been set to save received faxes in the product's memory or inbox, received faxes are not automatically printed. Check the **Fax Output** setting on the product control panel and change it, if necessary.
- If the product has been set to save received faxes in the product's memory or inbox, received faxes are not automatically printed. Check the **Receive Settings** options on the product control panel and change them, if necessary.

Parent topic: [Solving Faxing Problems](#)

Related references

[Receive Settings - Fax](#)

Solving USB Device Problems

Check these solutions if you have problems using USB devices with your product.

[Cannot View or Print from a USB Device](#)

[Cannot Save Files on a USB Device](#)

[Cannot Transfer Files To or From a USB Device](#)

Parent topic: [Solving Problems](#)

Cannot View or Print from a USB Device

If you cannot view or print photos or documents from a USB device connected to your product, try these solutions:

- Make sure memory devices are enabled on the product.
- Make sure your device is compatible with the product.
- Make sure the files on your device are in the correct format.

Parent topic: [Solving USB Device Problems](#)

Related references

[External USB Device Specifications](#)

Related tasks

[Disabling the External Interface](#)

Cannot Save Files on a USB Device

If you cannot save files on a USB device connected to your product, try these solutions:

- To save faxes on a USB device, create a folder using the unconditional save/forward settings on the product control panel.
- Make sure the device is not write-protected.
- Make sure the device has enough available space.
- Make sure memory devices are enabled on your product.
- Make sure the device is compatible with the product.

Parent topic: [Solving USB Device Problems](#)

Related references

[External USB Device Specifications](#)

Related tasks

[Disabling the External Interface](#)

Cannot Transfer Files To or From a USB Device

If you have problems transferring files to or from a USB device connected to your product, try these solutions:

- Make sure your device is compatible with the product.
- Make sure the device is not write-protected.
- Make sure there is enough free space on the device.
- Make sure your product is securely connected to your computer.
- Make sure that the file sharing setting for your product is enabled.

Parent topic: [Solving USB Device Problems](#)

Related references

[External USB Device Specifications](#)

Related tasks

[Disabling the External Interface](#)

Uninstall Your Product Software

If you have a problem that requires you to uninstall and re-install your software, follow the instructions for your operating system.



[Uninstalling Product Software - Windows](#)

[Uninstalling Product Software - Mac](#)

Parent topic: [Solving Problems](#)

Uninstalling Product Software - Windows

You can uninstall and then re-install your product software to solve certain problems.

1. Turn off the product.
2. Disconnect any interface cables.
3. Do one of the following:
 - **Windows 11:** Click , then search for **Settings** and select it. Select **Apps** or **System > Apps & features**. Then select the program you want to uninstall and select **Uninstall**.
 - **Windows 10:** Click  and select  (Settings) > **Apps** or **System > Apps & features**. Then select the program you want to uninstall and select **Uninstall**.

- **Windows 8.x:** Navigate to the **Apps** screen and select **Control Panel > Programs > Programs and Features**. Select the uninstall option for your Epson product, then select **Uninstall/Change**.

Note: If you see a **User Account Control** window, click **Yes** or **Continue**.

Select your product again, if necessary, then select **OK**, and click **Yes** to confirm the uninstallation.

- **Windows (other versions):** Click  or **Start**, and select **All Programs** or **Programs**. Select **EPSON**, select your product, then click **EPSON Printer Software Uninstall**.

Note: If you see a **User Account Control** window, click **Yes** or **Continue**.

In the next window, select your product and click **OK**. Then follow any on-screen instructions.

4. Do one of the following to uninstall Epson Scan, then follow any on-screen instructions:
 - **Windows 11/Windows 10:** Select **Epson Scan** and click **Uninstall**.
 - **Windows 8.x/Windows 7/Windows Vista:** Select **Epson Scan** and click **Uninstall/Change**.

Note: If you find that re-installing your product software does not solve a problem, contact Epson.

Parent topic: [Uninstall Your Product Software](#)

Uninstalling Product Software - Mac

In most cases, you do not need to uninstall your product software before re-installing it. However, you can download the Uninstaller utility from the Epson support website to uninstall your product software as described here.

Note: If you find that re-installing your product software does not solve a problem, contact Epson.

1. To download the Uninstaller utility, visit epson.com/support (U.S.), epson.ca/support (Canada), or latin.epson.com/support (Latin America) and select your product.
2. Click **Downloads**.
3. Select your operating system, click **Utilities**, locate the Uninstaller utility, and click **Download**.
4. Run the file you downloaded.
5. Double-click the **Uninstaller** icon.

6. In the Epson Uninstaller screen, select the checkbox for each software program you want to uninstall.
7. Click **Uninstall**.
8. Follow the on-screen instructions to uninstall the software.
9. Reinstall your product software.

Note: If you uninstall the printer driver and your product name remains in the **Print & Fax**, **Print & Scan**, or **Printers & Scanners** window, select your product name and click the – (remove) icon to remove it.

Parent topic: [Uninstall Your Product Software](#)

Where to Get Help (U.S. and Canada)

If you need to contact Epson for technical support services, use the following support options.

Internet Support

Visit Epson's support website at epson.com/support (U.S.), epson.ca/support (Canada), or latin.epson.com/support (Latin America) and select your product for solutions to common problems. You can download drivers and documentation, get FAQs and troubleshooting advice, or e-mail Epson with your questions.

Speak to a Support Representative

Before you call Epson for support, please have the following information ready:

- Product name
- Product serial number (located on a label on the product)
- Proof of purchase (such as a store receipt) and date of purchase
- Computer configuration
- Description of the problem

Then call:

- U.S. and Canada (English): (800) 241-5786, 7 a.m. to 4 p.m., Pacific Time, Monday through Friday
- Canada (French): (905) 709-3839, 7 a.m. to 4 p.m., Pacific Time, Monday through Friday

Days and hours of support are subject to change without notice. Toll or long distance charges may apply.

Purchase Supplies and Accessories

You can purchase genuine Epson ink and paper at epson.com (U.S. sales), epson.ca (Canadian sales), or latin.epson.com (Latin American sales). You can also purchase supplies from an Epson authorized reseller. To find the nearest one, call 800-GO-EPSON (800-463-7766) in the U.S. or 800-807-7766 in Canada.

Parent topic: [Solving Problems](#)

Where to Get Help (Latin America)

If you need additional help with your Epson product, contact Epson.

Epson provides these technical support services:

Internet Support

Visit Epson's support website at latin.epson.com/support for solutions to common problems. You can download drivers and documentation, get FAQs and troubleshooting advice, or e-mail Epson with your questions.

Speak to a Support Representative

Before you call Epson for support, please have the following information ready:

- Product name
- Product serial number (located on a label on the product)
- Proof of purchase (such as a store receipt) and date of purchase
- Computer configuration
- Description of the problem

Then call:

Country	Telephone
Argentina	(54 11) 5167-0300 0800-288-37766
Bolivia*	800-100-116
Brazil	0800-007-5000
Chile	(56 2) 2484-3400

Country	Telephone
Colombia	Bogota: (57 1) 602-4751 Other cities: 01-8000-915235
Costa Rica	800-377-6627
Dominican Republic*	1-888-760-0068
Ecuador*	1-800-000-044
El Salvador*	800-6570
Guatemala*	1-800-835-0358
Mexico	Mexico City: (52 55) 1323-2052 Other cities: 01-800-087-1080
Nicaragua*	00-1-800-226-0368
Panama*	00-800-052-1376
Paraguay	009-800-521-0019
Peru	Lima: (51 1) 418-0210 Other cities: 0800-10126
Uruguay	00040-5210067
Venezuela	(58 212) 240-1111

* Contact your local phone company to call this toll-free number from a mobile phone.

If your country does not appear in the list, contact the sales office in the nearest country. Toll or long distance charges may apply.

Purchase Supplies and Accessories

Parent topic: [Solving Problems](#)

Technical Specifications

These sections list the technical specifications for your product.

Note: Epson offers a recycling program for end of life Epson products. Please go to [this site](#) (U.S.) or [this site](#) (Canada) for information on how to return your Epson products for proper disposal.

[Windows System Requirements](#)

[Mac System Requirements](#)

[Paper Specifications](#)

[Printable Area Specifications](#)

[Automatic Document Feeder \(ADF\) Specifications](#)

[Scanning Specifications](#)

[Fax Specifications](#)

[Ink Pack Specifications](#)

[Dimension Specifications](#)

[Electrical Specifications](#)

[Environmental Specifications](#)

[Interface Specifications](#)

[External USB Device Specifications](#)

[Network Interface Specifications](#)

[Safety and Approvals Specifications](#)

Windows System Requirements

To use your product and its software, your computer should use one of these Microsoft operating systems:

- Windows 11
- Windows 10
- Windows 8.x
- Windows 7
- Windows Vista
- Windows Server 2003 SP2 or later

Note: For the latest product software available for your operating system, visit the Epson support site at epson.com/support (U.S.), epson.ca/support (Canada), or latin.epson.com/support (Latin America), select your product, and select **Downloads**.

Parent topic: [Technical Specifications](#)

Mac System Requirements

To use your product and its software, your Mac should use one of these operating systems:

- macOS 13.x
- macOS 12.x
- macOS 11.x
- macOS 10.15.x
- macOS 10.14.x
- macOS 10.13.x
- macOS 10.12.x
- OS X 10.11.x
- OS X 10.10.x
- OS X 10.9.x

Note: Mac OS may not support some applications and features; the UNIX File System (UFS) for Mac OS is not supported.

Note: For the latest product software available for your operating system, visit the Epson support site at epson.com/support (U.S.), epson.ca/support (Canada), or latin.epson.com/support (Latin America), select your product, and select **Downloads**.

Parent topic: [Technical Specifications](#)

Paper Specifications

Note: Since the quality of any particular brand or type of paper may be changed by the manufacturer at any time, Epson cannot guarantee the quality of any non-Epson brand or type of paper. Always test a sample of paper stock before purchasing large quantities or printing large jobs.

Single-sheets

Size

A4 (8.3 × 11.7 inches [210 × 297 mm])
A6 (4.1 × 5.8 inches [105 × 148 mm])
Letter (8.5 × 11 inches [216 × 279 mm])
Legal (8.5 × 14 inches [216 × 356 mm])
8.5 × 13 inches (216 × 330 mm)
Executive (7.25 × 10.5 inches [184 × 267 mm])
Mexico-Oficio (8.5 × 13.4 inches [216 × 340 mm])
Oficio 9 (8.46 × 12.4 inches [215 × 315 mm])
4 × 6 inches (102 × 152 mm)
5 × 7 inches (127 × 178 mm)
8 × 10 inches (203 × 254 mm)
16:9 wide (4 × 7.1 inches [102 × 181 mm])
Half Letter (5.5 × 8.5 inches [140 × 216 mm])

Paper types

Plain paper

Note: Your product also supports compatible papers distributed by Epson. See the link at the end of this topic for a list of compatible Epson papers.

Weight

Plain paper: 17 lb (64 g/m²) to 24 lb (90 g/m²)
Thick paper: 25 lb (91 g/m²) to 68 lb (256 g/m²)

Envelopes

Size

No. 10 (4.1 × 9.5 inches [105 × 241 mm])

Paper types

Plain bond paper

Weight

20 lb (75 g/m²) to 27 lb (100 g/m²)

Parent topic: [Technical Specifications](#)

Related references

[Compatible Epson Papers](#)

Printable Area Specifications

Single sheets

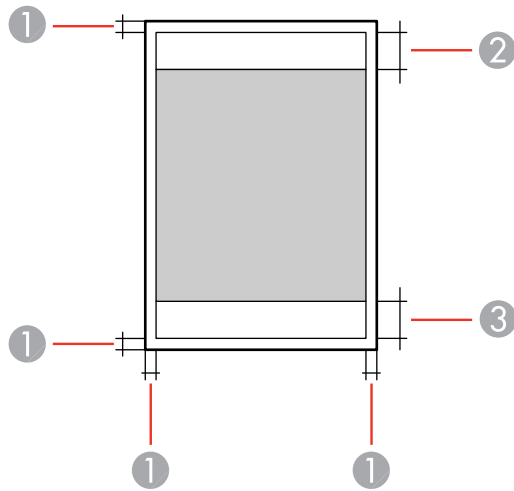

- 1 Top/bottom/right/left: 0.12 inch (3 mm) minimum
- 2 Reduced print quality area/top: 1.85 inches (47 mm) minimum
- 3 Reduced print quality area/bottom: 1.77 inches (45 mm) minimum

Envelopes

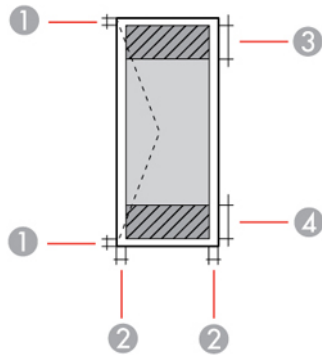

- 1 Left/right: 0.12 inch (3 mm) minimum
- 2 Top/bottom: 0.12 inch (3 mm) minimum
- 3 Reduced print quality area/left: 0.71 inch (18 mm) minimum
- 4 Reduced print quality area/right: 1.85 inches (47 mm) minimum

Parent topic: [Technical Specifications](#)

Automatic Document Feeder (ADF) Specifications

ADF type	Auto-duplex scanning
Paper size	US letter, legal, or A4 size, A6 (4.1 × 5.8 inches [105 × 148 mm]), 8.5 × 13 inches (216 × 330 mm), Mexico-Oficio (8.5 × 13.4 inches [216 × 340 mm]), Oficio 9 (8.46 × 12.4 inches [215 × 315 mm])
Paper type	Plain paper, high-quality plain paper, or recycled paper
Paper weight	17 lb (64 g/m ²) to 24 lb (95 g/m ²)
Sheet feeding capacity	Total thickness: 0.22 inch (5.5 mm) Approximately 50 sheets

Parent topic: [Technical Specifications](#)

Scanning Specifications

Scanner type	Flatbed, color
Photoelectric device	CIS
Effective pixels	10200 × 14040 pixels at 1200 dpi
Document size	Maximum: 8.5 × 11.7 inches (216 × 297 mm) Scanner glass: US letter or A4
Scanning resolution	1200 dpi (main scan) 2400 dpi (sub scan)
Output resolution	50 to 9600 dpi in 1 dpi increments
Image data	Color: 48 bits per pixel (16 bits per pixel per color) internal 24 bits per pixel (8 bits per pixel per color) external Grayscale: 16 bits per pixel internal 8 bits per pixel external Black and white: 16 bits per pixel internal 1 bit per pixel external
Light source	LED

Parent topic: [Technical Specifications](#)

Fax Specifications

Fax type	Black-and-white and color fax capability (ITU-T Super Group 3)
Supported lines	Standard analog phone lines PBX (Private Branch Exchange) telephone systems
Speed	Up to 33.6 kbps

Resolution	<p>Monochrome</p> <p>Standard: 203 pixels per inch × 98 lines per inch (8 pixels per mm × 3.85 lines per mm)</p> <p>Fine: 203 pixels per inch × 196 lines per inch (8 pixels per mm × 7.7 lines per mm)</p> <p>Super Fine: 203 pixels per inch × 392 lines per inch (8 pixels per mm × 15.4 lines per mm)</p> <p>Ultra Fine: 406 pixels per inch × 392 lines per inch (16 pixels per mm × 15.4 lines per mm)</p> <p>Color</p> <p>200 × 200 dpi</p>
Compression method	<p>Monochrome: MH/MR/MMR</p> <p>Color: JPEG</p>
Communication standards	G3, Super G3
Sending paper size	<p>Scanner Glass: Letter, A4</p> <p>ADF: Letter, A4, Legal</p>
Transmission speed (Actual speed depends on the document, recipient's device, and phone line status)	Approx. 3 seconds (transmitting a standard A4 ITU-T chart No. 1 with Standard MMR encryption at a speed of 33.6 kbps)
Contacts	<p>Number of contacts: up to 200</p> <p>Number of groups: up to 199</p>
Page memory	Up to 550 pages (when an ITU-T No. 1 chart is received in monochrome draft mode)
Redial	2 times (with 1 minute interval); may differ depending on your country or region
Interface	<p>RJ-11 Phone Line</p> <p>RJ-11 Telephone set connection</p>

Parent topic: [Technical Specifications](#)

Ink Pack Specifications

Note: Your printer is designed to work only with genuine Epson-brand ink packs. Other brands of ink packs and ink supplies are not compatible and, even if described as compatible, may not function properly or at all. Epson periodically provides firmware updates to address issues of security, performance, minor bug fixes and ensure the printer functions as designed. These updates may affect the functionality of third-party ink. Non-Epson branded or altered Epson ink packs that functioned prior to a firmware update may not continue to function.

The included initial ink packs are designed for reliable printer setup and cannot be used as replacement ink packs or resold. After setup, the remaining ink is available for printing. Yields are based on ISO 24711 in default mode, printing continuously. Yields vary due to print images, settings, and temperatures. Printing infrequently or primarily with one color reduces yields. All ink packs must be installed with ink for printing and printer maintenance. For print quality, some ink remains in replaced ink packs.

Color	Cyan, Magenta, Yellow, Black
Ink pack life	Opened package: 2 years Unopened package: do not use if the date on the package has expired
Temperature	Storage: -22 to 104 °F (-30 to 40 °C) 1 month at 104 °F (40 °C) Ink freezes at 18.6 °F (-7.45 °C) (depending on color; ink may partially freeze at 32 °F (0 °C) or lower) Ink thaws and is usable after 3 hours at 77 °F (25 °C)

Parent topic: [Technical Specifications](#)

Dimension Specifications

Height	Stored: 14.1 inches (357 mm) Stored with 1 optional paper cassette installed: 18 inches (457 mm) Stored with 2 optional paper cassettes installed: 21.9 inches (557 mm) Stored with 3 optional paper cassettes installed: 25.9 inches (657 mm) Printing: 17.7 inches (449 mm) Printing with one optional paper cassette installed: 21.6 inches (549 mm) Printing with two optional paper cassettes installed: 25.6 inches (649 mm) Printing with three optional paper cassettes installed: 29.5 inches (749 mm)
Width	Stored: 16.7 inches (425 mm) Printing: 16.7 inches (425 mm)
Depth	Stored: 21.1 inches (535 mm); with output tray installed Printing: 22.8 inches (578 mm)
Weight (without ink packs or power cord)	41.2 lb (18.7 kg) With one optional paper cassette installed: 51.1 lb (23.2 kg) With two optional paper cassettes installed: 61.1 lb (27.7 kg) With three optional paper cassettes installed: 71.0 lb (32.2 kg)

Parent topic: [Technical Specifications](#)

Related references
[Electrical Specifications](#)

Electrical Specifications

Power supply rating	100 to 240 V
----------------------------	--------------

Rated frequency range	50 to 60 Hz
Rated current	1.0 to 0.6 A
Power consumption	<p>WF-C5810:</p> <p>Standalone copying: Approximately 25 W (ISO/IEC24712)</p> <p>Ready mode: Approximately 11.7 W</p> <p>Sleep mode: Approximately 1.2 W</p> <p>Power off mode: Approximately 0.2 W</p> <p>WF-C5890:</p> <p>Standalone copying: Approximately 27 W (ISO/IEC24712)</p> <p>Ready mode: Approximately 11.7 W</p> <p>Sleep mode: Approximately 1.2 W</p> <p>Power off mode: Approximately 0.2 W</p>

Parent topic: [Technical Specifications](#)

Related references

[Dimension Specifications](#)

Environmental Specifications

Temperature	<p>Operating: 50 to 95 °F (10 to 35 °C)</p> <p>Storage: –4 to 104 °F (–20 to 40 °C) before initial ink charging</p> <p>5 to 104 °F (–15 to 40 °C) after initial ink charging</p> <p>1 month at 104 °F (40 °C)</p>
Humidity (without condensation)	<p>Operating: 20 to 80% RH</p> <p>Storage: 5 to 85% RH</p>

Parent topic: [Technical Specifications](#)

Interface Specifications

Interface type	Hi-Speed USB (Device Class for computers) Hi-Speed USB (for external USB device)
-----------------------	---

Note: Epson cannot guarantee the operation of externally connected devices. USB 3.0 cables are not supported.

Parent topic: [Technical Specifications](#)

External USB Device Specifications

Do not use devices with the following requirements:

- Dedicated driver
- Security settings, such as password or encryption, etc.

USB memory device	2TB Formatted in FAT, FAT32, or exFAT
--------------------------	--

Note: Epson cannot guarantee the operation of externally connected devices.

You can use USB devices with your product containing files that meet these specifications.

Note: The WF-C5810 does not support printing PDF files.

File format	JPEGs (*.JPG) with the Exif Version 2.31 standard taken by digital cameras (DCF version 1.0 or 2.0* compliant) TIFF 6.0-compliant uncompressed images: RGB full-color or binary (not CCITT-encoded) PDF version 1.7 compliant data
Image size	80 × 80 pixels to 10200 × 10200 pixels
File size	Up to 2GB

Number of files	JPEG: Up to 9990**
	TIFF: Up to 999
	PDF: Up to 999

* Files stored on digital cameras with built-in memory are not supported.

** If the number of files exceeds 999, the files are displayed in groups.

Parent topic: [Technical Specifications](#)

Network Interface Specifications

Wi-Fi (U.S. and Canada)

Standard	IEEE 802.11a/b/g/n ¹ /ac/k/r/v
Security	WPA2-PSK (AES); complies with WPA2 standards with support for WPA/WPA2 Personal
	WPA3-SAE (AES)
	WPA2/WPA-3-Enterprise
	WEP (64/128 bit)
	Note: Wi-Fi Direct only supports WPA2-PSK (AES)
Frequency band	IEEE 802.11b/g/n: 2.4 GHz
	IEEE 802.11a/n/ac: 5 GHz

Channels	<p>2.4 GHz: 1/2/3/4/5/6/7/8/9/10/11/12/13</p> <p>5 GHz:</p> <p>Wi-Fi:</p> <ul style="list-style-type: none"> • W52 (36/40/44/48) • W53 (52/56/60/64) • W56 (100/104/108/112/116/132/136/140/144) • W58 (149/153/157/161/165) <p>Wi-Fi Direct:</p> <ul style="list-style-type: none"> • W52 (36/40/44/48) • W58 (149/153/157/161/165)
Connection modes	<p>Infrastructure mode</p> <p>Wi-Fi Direct (Simple AP)</p> <p>Note: Wi-Fi Direct Simple AP mode is available even if you connect the product to an Ethernet network. Wi-Fi Direct is not supported on IEEE 802.11b.</p>
^{*1} : Only available for the HT20	
Wi-Fi (Latin America)	
Standard	IEEE 802.11 b/g/n ^{*1} /k/r/v
Security	<p>WPA2-PSK (AES); complies with WPA2 standards with support for WPA/WPA2 Personal</p> <p>WPA3-SAE (AES)</p> <p>WPA2/WPA-3-Enterprise</p> <p>WEP (64/128 bit)</p> <p>Note: Wi-Fi Direct only supports WPA2-PSK (AES)</p>
Frequency band	2.4 GHz
Channels	1/2/3/4/5/6/7/8/9/10/11/12/13

Coordination modes

Infrastructure mode
Wi-Fi Direct (Simple AP)

Note: Wi-Fi Direct Simple AP mode is available even if you connect the product to an Ethernet network. Wi-Fi Direct is not supported on IEEE 802.11b.

*1: Only available for the HT20

Ethernet**Standard**

IEEE802.3i (10BASE-T)*
IEEE802.3u (100BASE-TX)
IEEE802.3ab (1000BASE-T)*
IEEE802.3az (Energy Efficient Ethernet); the connected device should be IEEE802.3az compliant

Communication mode

Auto, 10Mbps Full duplex, 10Mbps Half duplex, 100Mbps Full duplex, 100Mbps Half duplex

Connector

RJ-45

* Use a category 5e or higher STP (Shielded twisted pair) cable to prevent risk of radio interference.

Security

IEEE802.1X; requires the connected device to comply with IEEE802.1X

IPsec/IP Filtering

SSL/TLS; either HTTPS Server/Client or IPPS

SMTPS (StartTLS, SSL/TLS)

SNMPv3

Parent topic: [Technical Specifications](#)

Safety and Approvals Specifications

United States

Safety: UL60950-1

EMC: FCC part 15 Subpart B Class B

Canada

Safety: CAN/CSA C22.2 No. 60950-1

EMC: CAN ICES-3 (B)/NMB-3 (B)

This equipment contains the following wireless module:

- Manufacturer: Seiko Epson Corporation
- Type: J26H005

This product conforms to Part 15 of FCC Rules and RSS-210 of the IC Rules. Epson cannot accept responsibility for any failure to satisfy the protection requirements resulting from a non-recommended modification of the product. Operation is subject to the following two conditions: (1) this device may not cause harmful interference, and (2) this device must accept any interference received, including interference that may cause undesired operation of the device.

To prevent radio interference to the licensed service, this device is intended to be operated indoors and away from windows to provide maximum shielding. Equipment (or its transmit antenna) that is installed outdoors is subject to licensing.

This equipment complies with FCC/IC radiation exposure limits set forth for an uncontrolled environment and meets the FCC radio frequency (RF) Exposure Guidelines in Supplement C to OET65 and RSS-102 of the IC radio frequency (RF) Exposure rules. This equipment should be installed and operated so that the radiator is kept at least 7.9 inches (20 cm) or more away from a person's body (excluding extremities: hands, wrists, feet and ankles).

Parent topic: [Technical Specifications](#)

Notices

Check these sections for important notices about your product.

Note: Epson offers a recycling program for end of life Epson products. Please go to [this site](#) (U.S.) or [this site](#) (Canada) for information on how to return your Epson products for proper disposal.

[Important Safety Instructions](#)

[FCC Compliance Statement](#)

[Binding Arbitration and Class Waiver](#)

[Trademarks](#)

[Copyright Notice](#)

Important Safety Instructions

Before using your Epson product, read and follow these safety instructions.

[General Printer Safety Instructions](#)

[Wireless Connection Safety Instructions](#)

[Telephone Equipment Safety Instructions](#)

[LCD Screen Safety Instructions](#)

Parent topic: [Notices](#)

General Printer Safety Instructions

- Be sure to follow all warnings and instructions marked on the printer.
- Use only the type of power source indicated on the printer's label.
- Use only the power cord that comes with the printer. Use of another cord may cause fires or shock. Do not use the cord with any other equipment.
- Make sure the AC power cord meets the relevant local safety standard.
- Place the printer near a wall outlet where the plug can be easily unplugged.
- Avoid plugging the printer into an outlet on the same circuit as a photo copier or air control system that regularly switches on and off, or on an outlet controlled by a wall switch or timer.
- Do not let the power cord become damaged or frayed.

- If you use an extension cord with the printer, make sure the total ampere rating of the devices plugged into the extension cord does not exceed the cord's ampere rating. Also, make sure the total ampere rating of all devices plugged into the wall outlet does not exceed the wall outlet's ampere rating.
- Always turn off the printer using the power button, and wait until the power light stops flashing before unplugging the printer or cutting off power to the electrical outlet.
- Place the printer on a flat, stable surface that extends beyond its base in all directions. It will not operate properly if it is tilted or at an angle.
- Keep your product at least 8.7 inches (22 cm) away from cardiac pacemakers to prevent your product's radio waves from affecting the operation of the pacemaker.
- Leave enough space above the printer to fully raise the printer cover.
- Leave enough space in front of the printer for the paper to be fully ejected.
- Avoid locations that are subject to rapid changes in heat or humidity, shocks or vibrations, or dust.
- Do not place the printer near a radiator or heating vent or in direct sunlight.
- Leave enough room around the printer for sufficient ventilation. Do not block or cover openings in the case or insert objects through the slots.
- The power-supply cords should be placed to avoid abrasions, cuts, fraying, crimping, and kinking. Do not place objects on top of the power-supply cords and do not allow the power-supply cords to be stepped on or run over. Be particularly careful to keep all the power-supply cords straight at the ends.
- Keep the printer away from potential sources of electromagnetic interference, such as loudspeakers or the base units of cordless telephones.
- When connecting the printer to a computer or other device with a cable, ensure the correct orientation of the connectors. Each connector has only one correct orientation. Inserting a connector in the wrong orientation may damage both devices connected by the cable.
- Do not insert objects through the slots on the printer.
- Do not put your hand inside the printer while it is printing.
- Do not trap your fingers when closing the scanner unit.
- Do not touch the flat white cable inside the printer.
- Do not move the print head by hand; this may damage the printer.
- Do not spill liquid on the printer and do not handle the printer with wet hands.
- Do not use aerosol products that contain flammable gases inside or around the printer. Doing so may cause fire.
- Except as specifically explained in your documentation, do not attempt to service the printer yourself.

- Unplug the printer and refer servicing to qualified service personnel under the following conditions: if the power cord or plug is damaged; if liquid has entered the product; if the product has been dropped or the case damaged; if the product does not operate normally or exhibits a distinct change in performance. Adjust only those controls that are covered by the operating instructions.
- If damage occurs to the plug, replace the cord set or consult a qualified electrician. If there are fuses in the plug, make sure you replace them with fuses of the correct size and rating.
- Never disassemble, modify, or attempt to repair the power cord, plug, printer, or options by yourself, except as specifically explained in the printer's manuals.
- Unplug the power cord from the electrical outlet if you are not going to use the printer for an extended period.
- Before transporting the printer, make sure that the print head is in the home (far right) position and the ink packs are installed.
- When storing or transporting the printer, do not tilt it, stand it on its side, or turn it upside down; otherwise, ink may leak.

Parent topic: [Important Safety Instructions](#)

Wireless Connection Safety Instructions

Radio waves from this product may adversely affect the operation of medical equipment or automatically controlled devices, such as pacemakers, automatic doors or fire alarms. When using this product near such devices or inside a medical facility, follow the directions from authorized staff members at the facility, and follow all posted warnings and directions on the device to avoid causing an accident.

Parent topic: [Important Safety Instructions](#)

Telephone Equipment Safety Instructions

When using telephone equipment, you should always follow basic safety precautions to reduce the risk of fire, electric shock, and personal injury, including the following:

- Do not use the Epson product near water.
- Avoid using a telephone during an electrical storm. There may be a remote risk of electric shock from lightning.
- Do not use a telephone to report a gas leak in the vicinity of the leak.

Caution: To reduce the risk of fire, use only a No. 26 AWG or larger telecommunication line cord.

Parent topic: [Important Safety Instructions](#)

LCD Screen Safety Instructions

- Use only a dry, soft cloth to clean the LCD screen. Do not use liquid or chemical cleansers.
- If the LCD screen is damaged, contact Epson. If the liquid crystal solution gets on your hands, wash them thoroughly with soap and water. If the liquid crystal solution gets into your eyes, flush them immediately with water. If discomfort or vision problems remain after a thorough flushing, see a doctor immediately.
- Do not press too hard on the LCD screen or subject it to heavy impacts.
- Do not use a pointy or sharp object, such as a pen or your fingernail, to operate the LCD screen.
- If the LCD screen chips or cracks, do not touch or attempt to remove the broken pieces; contact Epson for support.
- Do not subject your product to sudden changes in temperature or humidity; this may cause condensation to develop inside the LCD screen and degrade its performance.
- The LCD screen may contain a few small bright or dark spots, and may display uneven brightness. These are normal and do not indicate that the screen is damaged in any way.

Parent topic: [Important Safety Instructions](#)

FCC Compliance Statement

For United States Users

This equipment has been tested and found to comply with the limits for a Class B digital device, pursuant to Part 15 of the FCC Rules. These limits are designed to provide reasonable protection against harmful interference in a residential installation. This equipment generates, uses, and can radiate radio frequency energy and, if not installed and used in accordance with the instructions, may cause harmful interference to radio or television reception. However, there is no guarantee that interference will not occur in a particular installation. If this equipment does cause interference to radio and television reception, which can be determined by turning the equipment off and on, the user is encouraged to try to correct the interference by one or more of the following measures:

- Reorient or relocate the receiving antenna.
- Increase the separation between the equipment and receiver.
- Connect the equipment into an outlet on a circuit different from that to which the receiver is connected.
- Consult the dealer or an experienced radio/TV technician for help.

WARNING

The connection of a non-shielded equipment interface cable to this equipment will invalidate the FCC Certification or Declaration of this device and may cause interference levels which exceed the limits established by the FCC for this equipment. It is the responsibility of the user to obtain and use a shielded equipment interface cable with this device. If this equipment has more than one interface connector, do not leave cables connected to unused interfaces. Changes or modifications not expressly approved by the manufacturer could void the user's authority to operate the equipment.

For Canadian Users

CAN ICES-3(B)/NMB-3(B)

Parent topic: [Notices](#)

Binding Arbitration and Class Waiver

1. DISPUTES, BINDING INDIVIDUAL ARBITRATION, AND WAIVER OF CLASS ACTIONS AND CLASS ARBITRATIONS

1.1 Disputes. The terms of this Section 1 shall apply to all Disputes between you and Epson. The term "Dispute" is meant to have the broadest meaning permissible under law and includes any dispute, claim, controversy or action between you and Epson arising out of or relating to this Agreement, Epson branded products (hardware and including any related software), or other transaction involving you and Epson, whether in contract, warranty, misrepresentation, fraud, tort, intentional tort, statute, regulation, ordinance, or any other legal or equitable basis. "DISPUTE" DOES NOT INCLUDE IP CLAIMS, or more specifically, a claim or cause of action for (a) trademark infringement or dilution, (b) patent infringement, (c) copyright infringement or misuse, or (d) trade secret misappropriation (an "IP Claim"). You and Epson also agree, notwithstanding Section 1.6, that a court, not an arbitrator, may decide if a claim or cause of action is for an IP Claim.

1.2 Binding Arbitration. You and Epson agree that all Disputes shall be resolved by binding arbitration according to this Agreement. **ARBITRATION MEANS THAT YOU WAIVE YOUR RIGHT TO A JUDGE OR JURY IN A COURT PROCEEDING AND YOUR GROUNDS FOR APPEAL ARE LIMITED.** Pursuant to this Agreement, binding arbitration shall be administered by JAMS, a nationally recognized arbitration authority, pursuant to its code of procedures then in effect for consumer related disputes, but excluding any rules that permit joinder or class actions in arbitration (for more detail on procedure, see Section 1.6 below). You and Epson understand and agree that (a) the Federal Arbitration Act (9 U.S.C. §1, et seq.) governs the interpretation and enforcement of this Section 1, (b) this Agreement memorializes a transaction in interstate commerce, and (c) this Section 1 shall survive termination of this Agreement.

1.3 Pre-Arbitration Steps and Notice. Before submitting a claim for arbitration, you and Epson agree to try, for sixty (60) days, to resolve any Dispute informally. If Epson and you do not reach an agreement to

resolve the Dispute within the sixty (60) days), you or Epson may commence an arbitration. Notice to Epson must be addressed to: Epson America, Inc., ATTN: Legal Department, 3131 Katella Ave., Los Alamitos, CA 90720 (the "Epson Address"). The Dispute Notice to you will be sent to the most recent address Epson has in its records for you. For this reason, it is important to notify us if your address changes by emailing us at EAILEgal@ea.epson.com or writing us at the Epson Address above. Notice of the Dispute shall include the sender's name, address and contact information, the facts giving rise to the Dispute, and the relief requested (the "Dispute Notice"). Following receipt of the Dispute Notice, Epson and you agree to act in good faith to resolve the Dispute before commencing arbitration.

1.4 Small Claims Court. Notwithstanding the foregoing, you may bring an individual action in the small claims court of your state or municipality if the action is within that court's jurisdiction and is pending only in that court.

1.5 WAIVER OF CLASS ACTIONS AND CLASS ARBITRATIONS. YOU AND EPSON AGREE THAT EACH PARTY MAY BRING DISPUTES AGAINST THE OTHER PARTY ONLY IN AN INDIVIDUAL CAPACITY, AND NOT AS A PLAINTIFF OR CLASS MEMBER IN ANY CLASS OR REPRESENTATIVE PROCEEDING, INCLUDING WITHOUT LIMITATION FEDERAL OR STATE CLASS ACTIONS, OR CLASS ARBITRATIONS. CLASS ACTION LAWSUITS, CLASS-WIDE ARBITRATIONS, PRIVATE ATTORNEY-GENERAL ACTIONS, AND ANY OTHER PROCEEDING WHERE SOMEONE ACTS IN A REPRESENTATIVE CAPACITY ARE NOT ALLOWED. ACCORDINGLY, UNDER THE ARBITRATION PROCEDURES OUTLINED IN THIS SECTION, AN ARBITRATOR SHALL NOT COMBINE OR CONSOLIDATE MORE THAN ONE PARTY'S CLAIMS WITHOUT THE WRITTEN CONSENT OF ALL AFFECTED PARTIES TO AN ARBITRATION PROCEEDING.

1.6 Arbitration Procedure. If you or Epson commences arbitration, the arbitration shall be governed by the rules of JAMS that are in effect when the arbitration is filed, excluding any rules that permit arbitration on a class or representative basis (the "JAMS Rules"), available at <http://www.jamsadr.com> or by calling 1-800-352-5267, and under the rules set forth in this Agreement. All Disputes shall be resolved by a single neutral arbitrator, and both parties shall have a reasonable opportunity to participate in the selection of the arbitrator. The arbitrator is bound by the terms of this Agreement. The arbitrator, and not any federal, state or local court or agency, shall have exclusive authority to resolve all disputes arising out of or relating to the interpretation, applicability, enforceability or formation of this Agreement, including any claim that all or any part of this Agreement is void or voidable. Notwithstanding this broad delegation of authority to the arbitrator, a court may determine the limited question of whether a claim or cause of action is for an IP Claim, which is excluded from the definition of "Disputes" in Section 1.1 above. The arbitrator shall be empowered to grant whatever relief would be available in a court under law or in equity. The arbitrator may award you the same damages as a court could, and may award declaratory or injunctive relief only in favor of the individual party seeking relief and only to the extent necessary to provide relief warranted by that party's individual claim. In some instances, the costs of arbitration can exceed the costs of litigation and the right to discovery may be more limited in arbitration

than in court. The arbitrator's award is binding and may be entered as a judgment in any court of competent jurisdiction.

You may choose to engage in arbitration hearings by telephone. Arbitration hearings not conducted by telephone shall take place in a location reasonably accessible from your primary residence, or in Orange County, California, at your option.

a) Initiation of Arbitration Proceeding. If either you or Epson decides to arbitrate a Dispute, both parties agree to the following procedure:

(i) Write a Demand for Arbitration. The demand must include a description of the Dispute and the amount of damages sought to be recovered. You can find a copy of a Demand for Arbitration at <http://www.jamsadr.com> ("Demand for Arbitration").

(ii) Send three copies of the Demand for Arbitration, plus the appropriate filing fee, to: JAMS, 500 North State College Blvd., Suite 600 Orange, CA 92868, U.S.A.

(iii) Send one copy of the Demand for Arbitration to the other party (same address as the Dispute Notice), or as otherwise agreed by the parties.

b) Hearing Format. During the arbitration, the amount of any settlement offer made shall not be disclosed to the arbitrator until after the arbitrator determines the amount, if any, to which you or Epson is entitled. The discovery or exchange of non-privileged information relevant to the Dispute may be allowed during the arbitration.

c) Arbitration Fees. Epson shall pay, or (if applicable) reimburse you for, all JAMS filings and arbitrator fees for any arbitration commenced (by you or Epson) pursuant to provisions of this Agreement.

d) Award in Your Favor. For Disputes in which you or Epson seeks \$75,000 or less in damages exclusive of attorney's fees and costs, if the arbitrator's decision results in an award to you in an amount greater than Epson's last written offer, if any, to settle the Dispute, Epson will: (i) pay you \$1,000 or the amount of the award, whichever is greater; (ii) pay you twice the amount of your reasonable attorney's fees, if any; and (iii) reimburse you for any expenses (including expert witness fees and costs) that your attorney reasonably accrues for investigating, preparing, and pursuing the Dispute in arbitration. Except as agreed upon by you and Epson in writing, the arbitrator shall determine the amount of fees, costs, and expenses to be paid by Epson pursuant to this Section 1.6d).

e) Attorney's Fees. Epson will not seek its attorney's fees and expenses for any arbitration commenced involving a Dispute under this Agreement. Your right to attorney's fees and expenses under Section 1.6d) above does not limit your rights to attorney's fees and expenses under applicable law; notwithstanding the foregoing, the arbitrator may not award duplicative awards of attorney's fees and expenses.

1.7 Opt-out. You may elect to opt-out (exclude yourself) from the final, binding, individual arbitration procedure and waiver of class and representative proceedings specified in this Agreement by sending a written letter to the Epson Address within thirty (30) days of your assent

to this Agreement (including without limitation the purchase, download, installation of the Software or other applicable use of Epson Hardware, products and services) that specifies (i) your name, (ii) your mailing address, and (iii) your request to be excluded from the final, binding individual arbitration procedure and waiver of class and representative proceedings specified in this Section 1. In the event that you opt-out consistent with the procedure set forth above, all other terms shall continue to apply, including the requirement to provide notice prior to litigation.

1.8 Amendments to Section 1. Notwithstanding any provision in this Agreement to the contrary, you and Epson agree that if Epson makes any future amendments to the dispute resolution procedure and class action waiver provisions (other than a change to Epson's address) in this Agreement, Epson will obtain your affirmative assent to the applicable amendment. If you do not affirmatively assent to the applicable amendment, you are agreeing that you will arbitrate any Dispute between the parties in accordance with the language of this Section 1 (or resolve disputes as provided for in Section 1.7, if you timely elected to opt-out when you first assented to this Agreement).

1.9 Severability. If any provision in this Section 1 is found to be unenforceable, that provision shall be severed with the remainder of this Agreement remaining in full force and effect. **The foregoing shall not apply to the prohibition against class or representative actions as provided in Section 1.5. This means that if Section 1.5 is found to be unenforceable, the entire Section 1 (but only Section 1) shall be null and void.**

Parent topic: [Notices](#)

Trademarks

EPSON® is a registered trademark, the EPSON logo is a registered logomark, and Epson Connect™ is a trademark of Seiko Epson Corporation.

Remote Print™ is a trademark of Seiko Epson Corporation.

Windows is a registered trademark of Microsoft Corporation in the United States and/or other countries.

Mac, macOS, OS X, AirPrint, iPad, iPhone, iPod touch, and App Store are trademarks of Apple Inc., registered in the U.S. and other countries.

Use of the Works with Apple badge means that an accessory has been designed to work specifically with the technology identified in the badge and has been certified by the developer to meet Apple performance standards.

Google® is a registered trademark and Android™, Chromebook™, Gmail™, Google Chrome™, and Google Play™ are trademarks of Google LLC.

Wi-Fi Direct® is a registered trademark of Wi-Fi Alliance®.

PCL is a registered trademark of Hewlett-Packard Company.

General Notice: Other product names used herein are for identification purposes only and may be trademarks of their respective owners. Epson disclaims any and all rights in those marks.



Parent topic: [Notices](#)

Copyright Notice

All rights reserved. No part of this publication may be reproduced, stored in a retrieval system, or transmitted in any form or by any means, electronic, mechanical, photocopying, recording, or otherwise, without the prior written permission of Seiko Epson Corporation. The information contained herein is designed only for use with this Epson product. Epson is not responsible for any use of this information as applied to other products.

Neither Seiko Epson Corporation nor its affiliates shall be liable to the purchaser of this product or third parties for damages, losses, costs, or expenses incurred by purchaser or third parties as a result of: accident, misuse, or abuse of this product or unauthorized modifications, repairs, or alterations to this product, or (excluding the U.S.) failure to strictly comply with Seiko Epson Corporation's operating and maintenance instructions.

Seiko Epson Corporation shall not be liable for any damages or problems arising from the use of any options or any consumable products other than those designated as Original Epson Products or Epson Approved Products by Seiko Epson Corporation.

Seiko Epson Corporation shall not be held liable for any damage resulting from electromagnetic interference that occurs from the use of any interface cables other than those designated as Epson approved Products by Seiko Epson Corporation.

This information is subject to change without notice.

[libTIFF Software Acknowledgment](#)

[A Note Concerning Responsible Use of Copyrighted Materials](#)

[Default Delay Times for Power Management for Epson Products](#)

[Copyright Attribution](#)

Parent topic: [Notices](#)

libTIFF Software Acknowledgment

Copyright © 1988-1997 Sam Leffler

Copyright © 1991-1997 Silicon Graphics, Inc.

Permission to use, copy, modify, distribute, and sell this software and its documentation for any purpose is hereby granted without fee, provided that (i) the above copyright notices and this permission notice appear in all copies of the software and related documentation, and (ii) the names of Sam Leffler and Silicon Graphics may not be used in any advertising or publicity relating to the software without the specific, prior written permission of Sam Leffler and Silicon Graphics.

THE SOFTWARE IS PROVIDED "AS-IS" AND WITHOUT WARRANTY OF ANY KIND, EXPRESS, IMPLIED OR OTHERWISE, INCLUDING WITHOUT LIMITATION, ANY WARRANTY OF MERCHANTABILITY OR FITNESS FOR A PARTICULAR PURPOSE.

IN NO EVENT SHALL SAM LEFFLER OR SILICON GRAPHICS BE LIABLE FOR ANY SPECIAL, INCIDENTAL, INDIRECT OR CONSEQUENTIAL DAMAGES OF ANY KIND, OR ANY DAMAGES WHATSOEVER RESULTING FROM LOSS OF USE, DATA OR PROFITS, WHETHER OR NOT ADVISED OF THE POSSIBILITY OF DAMAGE, AND ON ANY THEORY OF LIABILITY, ARISING OUT OF OR IN CONNECTION WITH THE USE OR PERFORMANCE OF THIS SOFTWARE.

Parent topic: [Copyright Notice](#)

A Note Concerning Responsible Use of Copyrighted Materials

Epson encourages each user to be responsible and respectful of the copyright laws when using any Epson product. While some countries' laws permit limited copying or reuse of copyrighted material in certain circumstances, those circumstances may not be as broad as some people assume. Contact your legal advisor for any questions regarding copyright law.

Parent topic: [Copyright Notice](#)

Default Delay Times for Power Management for Epson Products

This product will enter sleep mode after a period of nonuse. This is to ensure that the product meets Energy Star standards of energy efficiency. More energy savings can be achieved by setting the time to sleep to a shorter interval.

Parent topic: [Copyright Notice](#)

Copyright Attribution

© 2023 Epson America, Inc.

5/23

CPD-62460R1

Parent topic: [Copyright Notice](#)