



AFINIA LABEL®

L901 COLOR LABEL PRINTER



OPERATOR MANUAL

[Click here for more information!](#)



IPsi INTEGRATED
PRODUCTIVITY
SYSTEMS

(844) 477-4911 | www.ipsiscan.com

Powered by

memjet®



8150 Mallory Ct.
Chanhassen, MN 55317
Toll Free: (888) 215-3966
Direct: (952) 556-1600
afinialabel.com

v1.6

SAFETY PRECAUTIONS

THIS EQUIPMENT PRESENTS NO PROBLEM WHEN USED PROPERLY. OBSERVE SAFETY RULES WHEN OPERATING THE L901 LABEL PRINTER.

BEFORE USING PRINTER, READ THIS MANUAL CAREFULLY AND FOLLOW RECOMMENDED PROCEDURES, SAFETY WARNINGS, AND INSTRUCTIONS:

- ✓ Keep hands, hair, and clothing clear of rollers and other moving parts.
- ✓ Avoid touching moving parts or materials while machine is in use. Before clearing a jam, be sure machine mechanisms come to a stop.
- ✓ Always turn machine off before making adjustments, cleaning the machine, or performing any maintenance covered in this manual.
- ✓ Power cord and power supply supplied with machine. Plug it into a properly grounded, easily accessible wall outlet near machine. Failure to properly ground machine can result in severe personal injury and/or fire.
- ✓ Power cord and wall plug are primary means of disconnecting machine from power supply.
- ✓ **DO NOT** use an adapter plug on line cord or wall outlet.
- ✓ **DO NOT** remove ground pin from line cord.
- ✓ **DO NOT** route power cord over sharp edges or trap it between furniture.
- ✓ Avoid using wall outlets that are controlled by wall switches or shared with other equipment.
- ✓ Make sure there is no strain on power cord caused by jamming it between equipment, walls or furniture.
- ✓ **DO NOT** remove covers. Covers enclose hazardous parts that should only be accessed by a qualified service representative. Report any cover damage to your service representative.
- ✓ This machine requires periodic maintenance. Contact your authorized service representative for required service schedules.
- ✓ To prevent overheating, do not cover vent openings.
- ✓ Use this equipment only for its intended purpose.

In addition, follow any specific occupational safety and health standards for your workplace or area.

This manual is intended solely for the use and information of Afinia Label, its designated agents, customers, and their employees. The information in this guide was obtained from several different sources that are deemed reliable by all industry standards. To the best of our knowledge, that information is accurate in all respects. However, neither Afinia Label nor any of its agents or employees shall be responsible for any inaccuracies contained herein.

Memjet® is a registered trademark.

All other trademarks are the property of their respective holders.

All rights reserved. No part of this book may be reproduced or transmitted in any form or by any means, electronic or mechanical, including photocopying, recording, or any information storage and retrieval system without permission in writing from the publisher.

SECTION 1 – <i>Getting Acquainted</i>	1
Parts of the Printer	1
SECTION 2 – <i>Installing Printer</i>	6
Contents of Packaging	6
Choose a Location	6
Unpack and Set-up	6
Attachments	6
Install Ink Drip Tray Assembly	7
Connect Printer	8
Connect to Computer	8
Install Printer Driver	9
Install Over USB Connection	9
Install Over Network Connection	11
Install Ink Tanks	16
First Time Install Printhead	17
Connect Printer to External Device	20
Align External Devices to Printer	20
Load Media	20
Media Specifications	21
SECTION 3 – <i>Operating Printer</i>	23
Printer Driver Properties	23
General Tab	24
Layout Tab	25
Color Tab	25
Media Tab	26
Import/Export Tab	28
Using Printer Touchscreen	29
Drop-Down Menu Options	29
Using the USB Back-Up Port	38
Using Printer Toolbox	40
Drop-Down Menu Options	40
System Settings	46
Maintenance Drop-Down	52
Service Drop-Down	52
Print Drop-Down	52
SECTION 4 – <i>Maintenance</i>	53
Replace Ink Tanks	53
Clean Ink Tank Contacts	54
Clean/Replace Printhead	55
Inspect the Service Station	59
Replace Ink Waste Tray	60
Remove Jammed Media	60
Misfeeds	60
Cleaning	61
Shipping or Transporting Printer	63
SECTION 5 – <i>Troubleshooting Guide</i>	65
Memjet® Printhead	65
Printer	66
Errors and Warnings	67
Appendices	72
Appendix A – Printer Specifications	72
Appendix B – Supplies and Optional Hardware	73
Appendix C – Borderless Printing: Borderless Print vs. Oversize	74
Appendix D – External Connections – GPIO details	78
Appendix E – Memjet Printhead Best Practices	79
Index	80

NOTES

SECTION 1 – *Getting Acquainted*

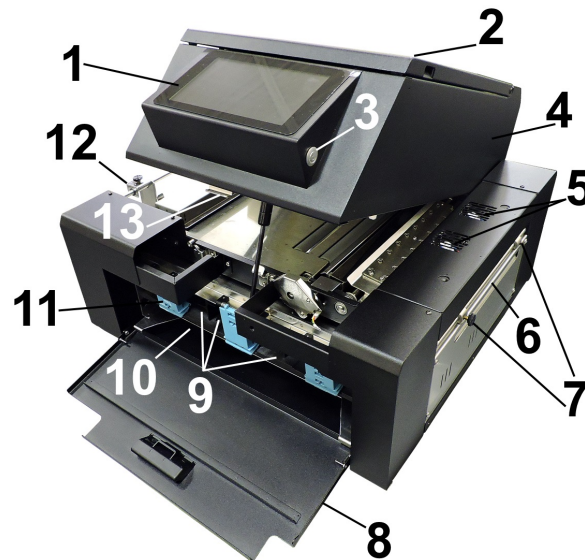

Parts of the Printer

Front View and Right Side

1.	Control Panel Touchscreen – Displays Menu and information about Printer status. Controls Printer functions and setup.
2.	Top Cover – Provides access to Print Engine, Printhead and Service Station.
3.	ON/OFF LED Button – Turn power ON or OFF during idle time and maintenance.
4.	Top Assembly ("Clamshell") – Holds upper section of Print Engine including Printhead and Service Station. Lifts up to clear media path.
5.	Ink Vapor Exhaust Fan – Draws ink vapor out of the Print Area and away from the Exit Sensor.
6.	Cutter Assembly – Cuts media after each piece or at end of job.
7.	Fixed and Adjustable Exit Media Guides – Loosen and tighten knob to slide Adjustable Exit Guide to accommodate different media widths and keep media aligned as it exits the Printer.
8.	Ink Tank Door – Access to Ink Tanks. When open, disconnects Printer communication to Ink Tanks and allows safe installation and replacement.
9.	Ink Tanks – Printer has five Ink Tanks: Cyan, Yellow, Magenta, and two Black.
10.	Ink Waste Tray – Catches any waste ink produced by system. Tray is filled with absorbent material. Pull on tabs to remove Tray.
11.	Ink Tank Latches – Used to hold Ink Tanks in slots. NOTE: Make sure both sides at bottom part of latch are engaged.
12.	Adjustable Media Guide – Adjusts to hold media against Media and Alignment Guides.
13.	Top Assembly Latch – Release to raise Printhead Assembly to clear media jams or for other maintenance.

**SECTION 1
GETTING ACQUAINTED**

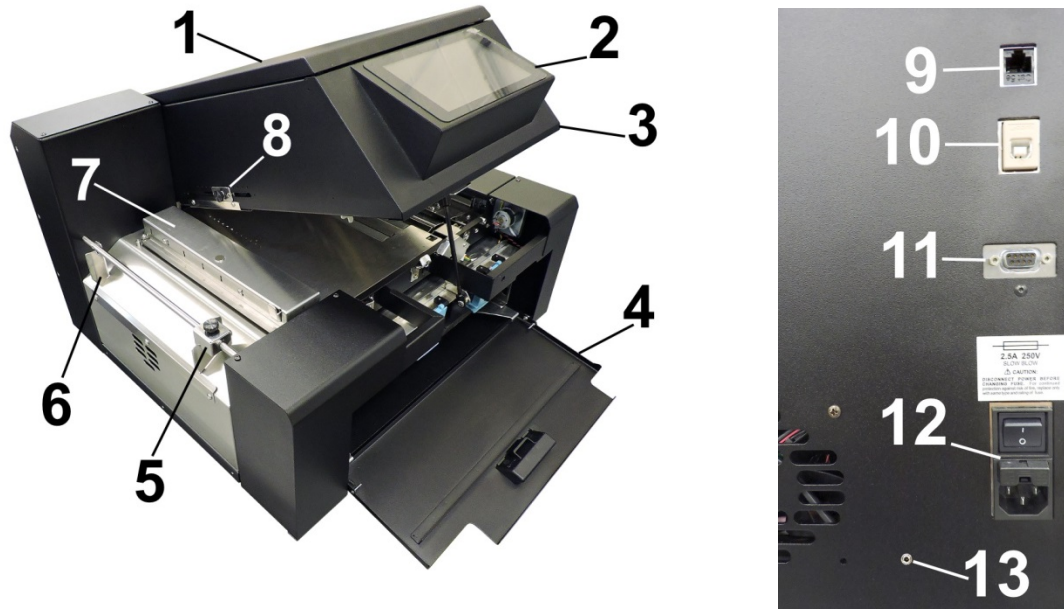

Left Side and Rear View

1.	Top Cover – Provides access to Print Engine, Printhead and Service Station.
2.	Control Panel Touchscreen – Displays Menu and information about Printer status. Controls Printer functions and setup.
3.	Top Assembly ("Clamshell") – Holds upper section of Print Engine including Printhead and Service Station. Lifts up to clear media path.
4.	Ink Tank Door – Access to Ink Tanks. When open, a switch disconnects Printer communication to Ink Tanks and allows safe Ink Tank installation and replacement.
5.	Adjustable Media Guide – Adjusts to hold media against Stationary Media and Alignment Guides.
6.	Fixed Media Guide – Keeps media aligned as it enters the Printer.
7.	Top Forwarding Wheels Assembly and Forwarding Rollers – Move media smoothly into the Printer.
8.	Adjustable Media (Entry) Sensor – Aligns the Media Sensor to accurately read irregular-shaped media (<i>such as die-cut ovals or circles</i>).
9.	Network Port – Ethernet cable plugs in here.
10.	USB Port – USB cable attaches to Printer here.
11.	Interface Port – Connect an external device.
12.	Main Power Switch, Receptacle and Fuse – Plug in power cord here. Switch turns main power ON/OFF. (<i>Use Control Panel LED Power switch to turn off machine for cleaning and maintenance</i>). Fuse protects Printer's electronic circuits.
13.	Service Port – Provides advanced diagnostic access for service technicians.

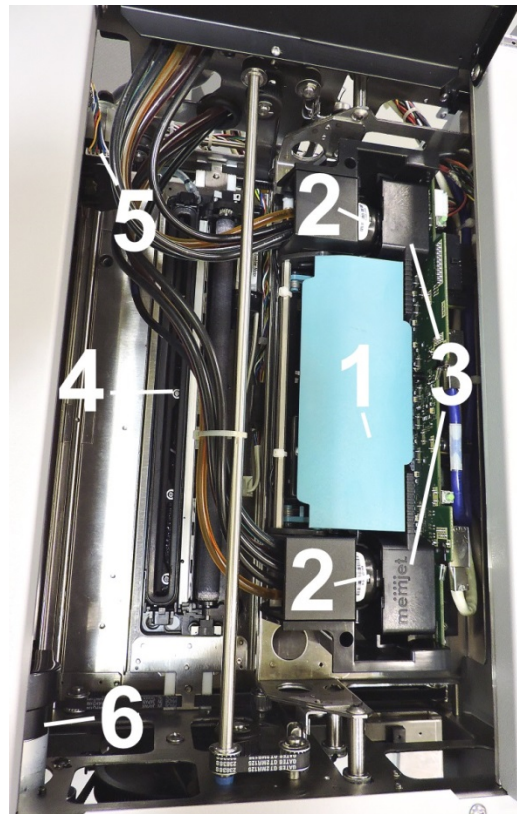

Print Engine View

1.	<p>Printhead Latch – When closed, connects Ink Revolver Couplings with Printhead. When opened, retracts Ink Couplings from Printhead and provides access to Printhead for cleaning and replacement.</p> <p>WARNING! Never attempt to open Printhead Latch manually, severe damage will result. Use the Printhead Release in the Touchscreen "Service" drop-down menu when no ink is in system. Use System Deprime when ink is in system.</p>
2.	<p>Ink Revolver Couplings – Connect ink hoses to Printhead. Printhead Latch extends and retracts couplings from Printhead.</p>
3.	<p>Printhead – Memjet® Printhead produces an 8.5" wide full color print area.</p>
4.	<p>Service Station – Cleans Printhead of excess ink and debris, keeps Printhead hydrated and protected when not in use, captures and removes ink used to keep nozzles clear, and moves out of the way of the Printhead during printing.</p>
5.	<p>Service Station Inspection Motor – Moves the Service Station in and out from under the Printhead Assembly for inspection, cleaning or service.</p>
6.	<p>Printhead Assembly Lifter Motor – Lifts and lowers the Printhead Assembly over the Service Station for Service Station access and Printing.</p>

**SECTION 1
GETTING ACQUAINTED**

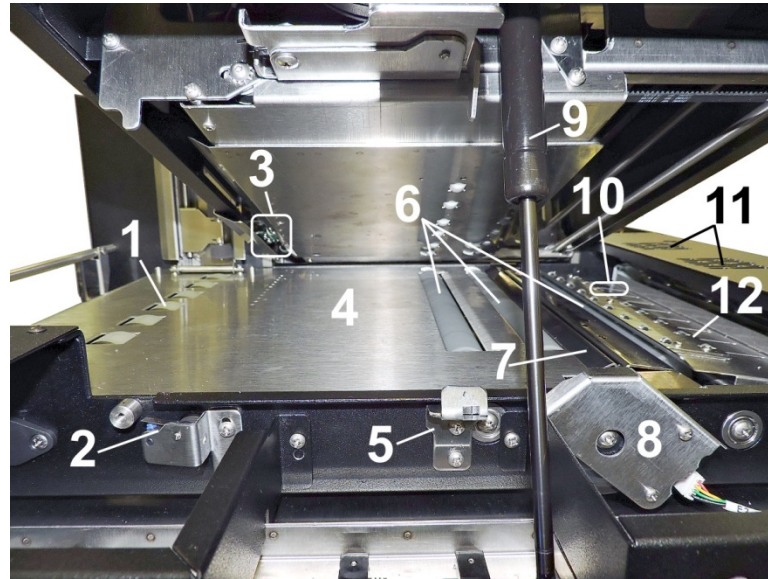

Print Area View (Under Top Assembly)

1.	Forwarding Rollers – Move media into Printer.
2.	Top Assembly "Open" Switch – Signals Printer when the Top Assembly Latch is released and Top Assembly is opened. Shows on Touchscreen display and in Toolbox System Status icon.
3.	Adjustable Media (Entry) Sensor – Aligns the Media Sensor to accurately read irregular-shaped media (<i>such as die-cut ovals or circles</i>).
4.	Print Platen – Flat surface helps media transport smoothly through Print Area.
5.	Top Assembly Latch – Release to raise Top Assembly to clear media jams or for cleaning and other maintenance.
6.	Transport Rollers – Keep media moving through Print Area.
7.	Ink Drip Cover and Tray – Located under Printhead. Catches any excess ink coming from Service Station and Printhead.
8.	Encoder Assembly and Guard.
9.	Support Strut – Supports Top Assembly when raised.
10.	Media (Exit) Sensor – Signals Printer that media has exited the Printer.
11.	Ink Vapor Exhaust Fans – Draw ink vapor out of the Print Area and away from the Exit Sensor.
12.	Exit Starwheel Assembly – Helps media exit smoothly from Printer.

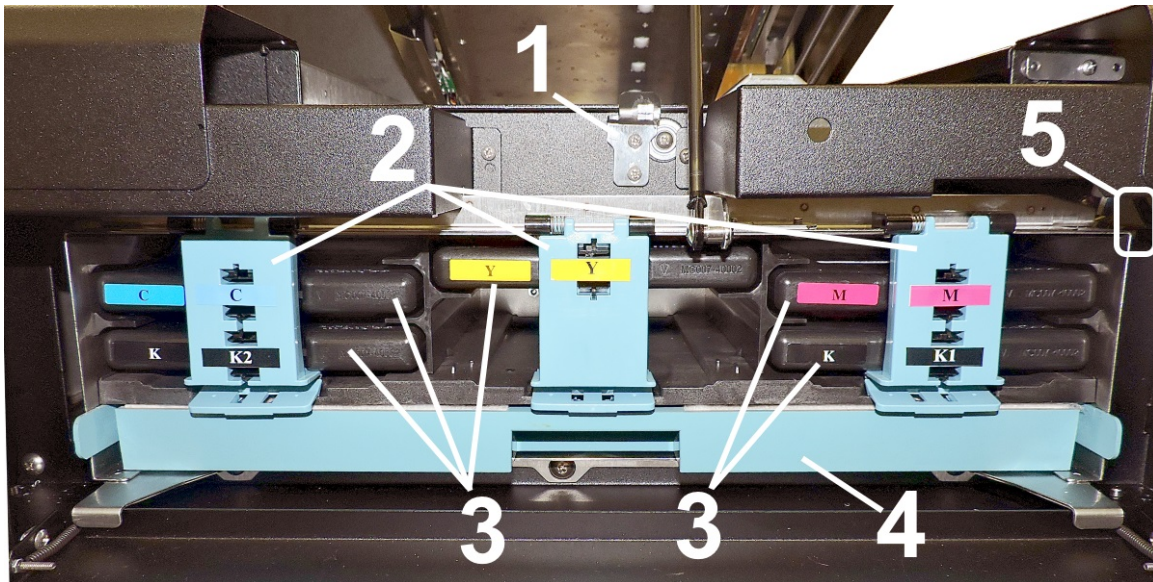

Ink Tank Door View

1.	Print Engine Assembly Latch – Release to raise Printhead Assembly to clear media jams or for other maintenance.
2.	Ink Tank Latches – Used to hold Ink Tanks in slots. NOTE: Make sure both sides at bottom part of latch are engaged.
3.	Ink Tanks – Printer has 5 Ink Tanks: Cyan, Yellow, Magenta, and two Black
4.	Ink Waste Tray – Catches any waste ink produced by system. Tray is filled with absorbent material. Pull on tabs to remove Tray.
5.	Ink Tank Disconnect Switch – When Ink Door is opened, switch shuts down communication between Printer and Ink Tanks for safe removal and replacement.

SECTION 2 – *Installing Printer*

Contents of Packaging

1	L901 Label Printer
2	Ink Drip Tray Assembly
3	AC Power Cord
4	USB Cable
5	Network Cable
6	Print head
7	Quick start guide

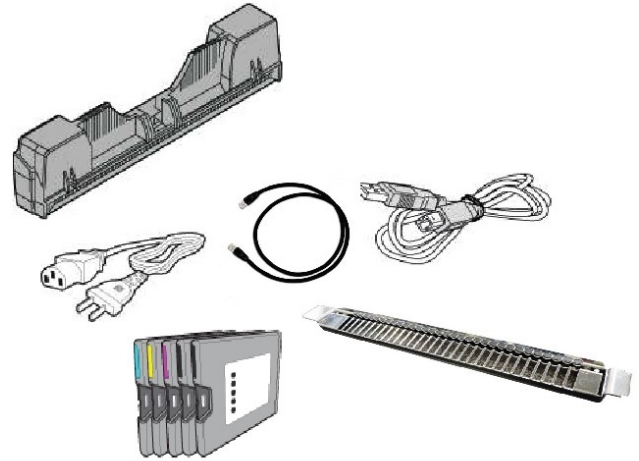

Before using Label Printer:

- Choose a location for Printer
- Unpack Printer
- Install Printer Driver
- Plug in Printer and connect it to computer or network
- Install Ink Tanks
- Install Printhead
- Align Printer with other in-line devices, if used (*Unwinder, Rewinder, Laminator, etc.*)
- Connect other in-line devices to Printer
- Set up feed on Printer



Choose a Location

Place the Printer on a sturdy level worktable or cabinet at least 9" from any walls. Use a level to make sure the Printer is level. Protect the Printer from excessive heat, dust, and moisture. Avoid placing the Printer in direct sunlight.

Unpack and Set-up

Remove Printer and its parts from carton. Remove all packing tape.

Attachments

Install Ink Drip Tray Assembly before operating Printer!

Install alignment plates for use with external equipment such as Unwinders and Winders.

Install Ink Drip Tray Assembly

Do not run the printer without the Ink Drip Tray in place!

1. Open Ink Tank Door [A].
2. Release Latch [B] to raise the Top Assembly.
3. Insert tabs on Ink Drip Tray into frame slots [C] as shown.



4. Close Top Assembly.

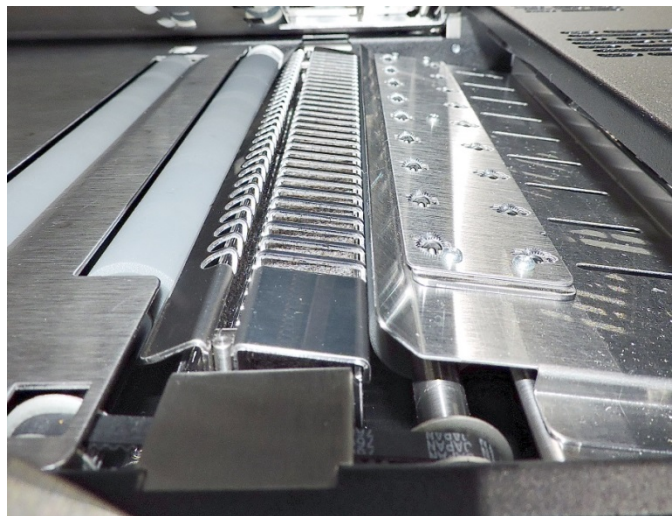
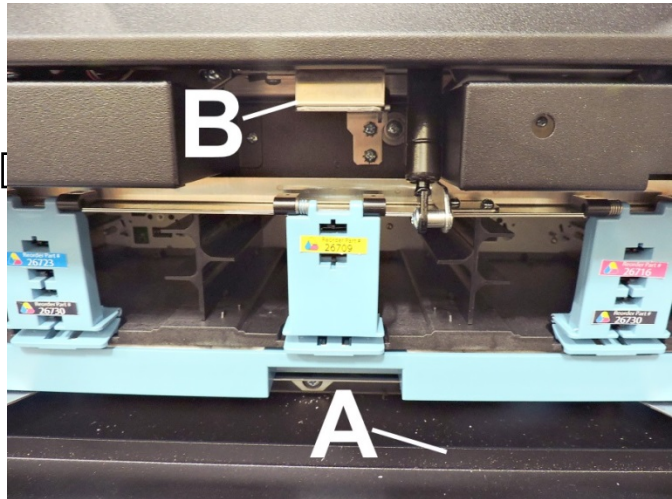

SECTION 2 INSTALLING PRINTER

Connect Printer

Plugging in Printer

Plug power cord into receptacle [1] located on the rear panel of the Printer.

Internal power supply in Printer is rated 115 to 240VAC, 50/60 Hz.

CAUTION
DO NOT USE ADAPTER PLUGS OR EXTENSION CORDS TO CONNECT PRINTER TO WALL RECEPTACLE.
DO NOT USE OUTLETS CONTROLLED BY WALL SWITCHES.
DO NOT USE OUTLETS THAT SHARE SAME CIRCUIT WITH LARGE ELECTRICAL MACHINES OR APPLIANCES.



Connect to Computer

Printer connects to computer through **USB Port [2]**.

Network Port [3] for operating in a network environment.

See “[Install Over Network Connection](#)” on page 11.

Turning Power ON and OFF

Powering Up Printer:

1. Press Main Power Switch on Rear Panel.
2. Press Power Button on Control Panel.

Powering Down Printer:

CAUTION
WHENEVER POWERING DOWN UNIT, ALWAYS:
1. PRESS POWER BUTTON ON CONTROL PANEL.
2. WAIT FOR PRINTER TO STOP PROCESSING AND GREEN POWER LED TO GO OFF.
3. THEN PRESS MAIN POWER SWITCH ON REAR PANEL.

Install Printer Driver

Download the driver installer file from our website:

<https://afinialabel.com/product-support/l901-support/>

For Printer software to operate properly, check that computer system meets **minimum requirements**:

- **Operating System:** Windows 8/8.1, Windows 10 (*Desktop Mode only*). Windows 7. Supports 32 and 64 bit systems.
NOTE: Windows 8, 8.1 and Windows 10 will only work in desktop mode. No Windows 8 or 10 metro apps (*applications that work ONLY in Windows 8 or 10 environments*) are supported.
- **You must have administrative privileges on system.**
- **Microprocessor:** Pentium II, 2 GHz minimum (*Pentium Dual Core, 2.5 GHz or better, is optimal*)
- **System memory:** 2 GB minimum; or as recommended for your operating system.
- **Free hard drive space:** At least 10 GB.
- **Web Browser:** Firefox recommended; Chrome, Safari, and Opera also supported.
- Installer can be downloaded from <https://afinialabel.com/product-support/l901-support/>
- **USB port (2.0/3.0):** (*Ports will be identified as “USB” or “Enhanced” in Device Manager*)
- Microsoft .Net Framework version 3.5 (*for 32 bit systems*) or Microsoft .Net Framework version 4 (*for 64 bit systems*) must be installed.
NOTE: Even if a higher .NET Framework version is installed; version 3.5 or 4 must also be installed, or Toolbox will not open.

IMPORTANT: Before installing Printer software (*Toolbox and Driver*), **temporarily disable all antivirus programs and firewalls**. In addition, you must be logged onto system with full administrative privileges (*admin rights*).

The Printer can be installed using a USB connection or over a network connection.

NOTE: If installing over USB, **do not plug in USB cable until prompted**.

Install Over USB Connection

1. Check that the Printer is plugged in and turned OFF. **Disconnect USB connection if already plugged in**. Unzip the file from the website. Run WinSetup.exe to start installation.

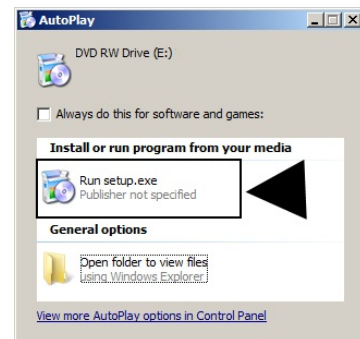

2. **Install Driver.**

Make sure computer system meets **minimum requirements** and you followed other instructions listed on screen.

Click **“Install Driver”**.



SECTION 2 INSTALLING PRINTER

3. License Agreement.

Check “I accept...” then click “Next>”.

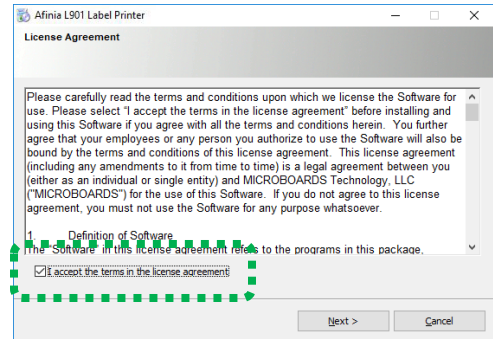

4. Printer Connections. Click “Configure to print using USB”. Then click “Next>”.

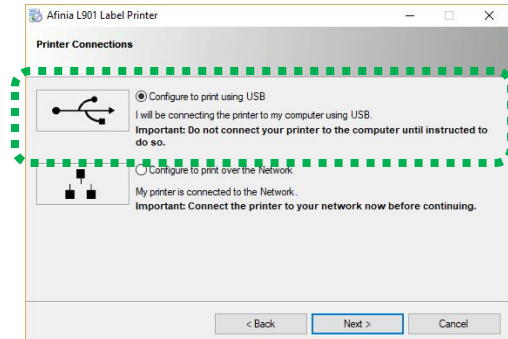

5. Installing Printer Software.

Driver pre-installation begins.

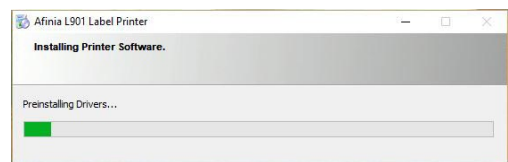

6. Would You Like to Install This Device Software?

Click “Install”.

You may see this message more than once as the drivers are installed.

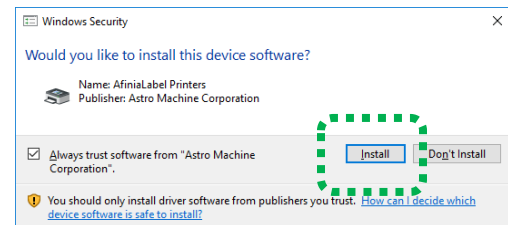

7. Connect Device Now. Turn Printer ON and connect USB cable.

Do not click the Back or Cancel buttons.

The Printer will be recognized and the drivers will finish installing.

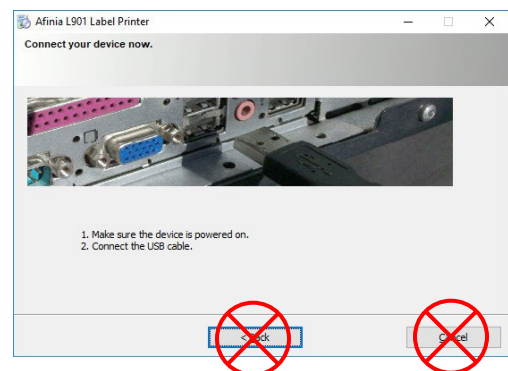

- 8. Finish software installation.** You can check “Set this printer as the default printer” at this time.
Click “**Finish**”.

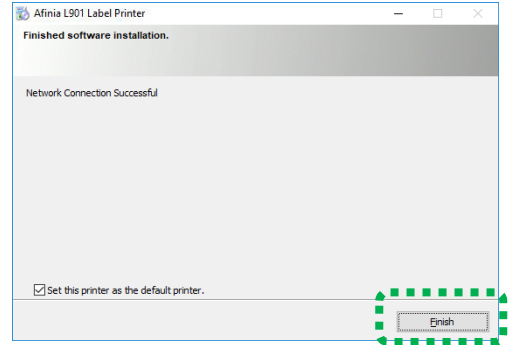

- 9. Install Driver window**
Click Install Driver again to add another printer, or close Installer.
- 10. Restart computer to complete installation.**



Install Over Network Connection

There are two methods of installing over a network connection.

Method A

This procedure works for almost all networks that allow automatic assignment of the IP address (*factory default*).

NOTE: Copy the 12-digit Hardware ID number listed on the Printer(s) on the label located below the Ethernet port so you can identify the Printer(s) in a later step.

- Check that Printer is plugged in and turned ON. **Make sure the Ethernet (network) cable is plugged into the Ethernet port on the Printer.** Unzip the file from the website. Run WinSetup.exe to start installation.
- 2. Install Driver.**
Make sure computer system meets **minimum requirements**. Follow all other instructions listed on screen.
Click “**Install Driver**”.

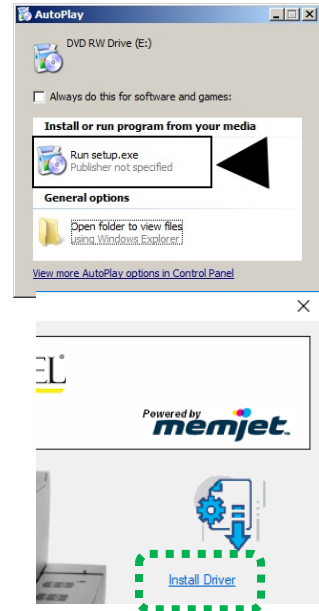

SECTION 2 INSTALLING PRINTER

3. License Agreement.

Check “I accept...” then click “Next>”.

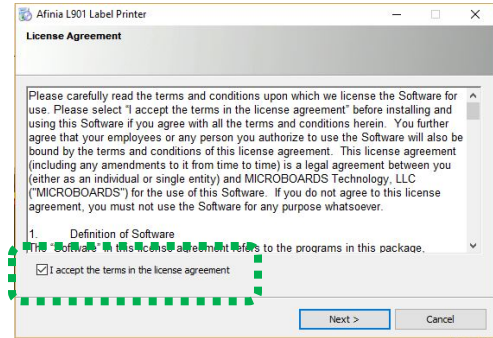

4. Printer Connections. Click “Configure to print using the Network”. Make sure the Printer is connected to the Network and has been assigned an IP Address. Then click “Next>”.

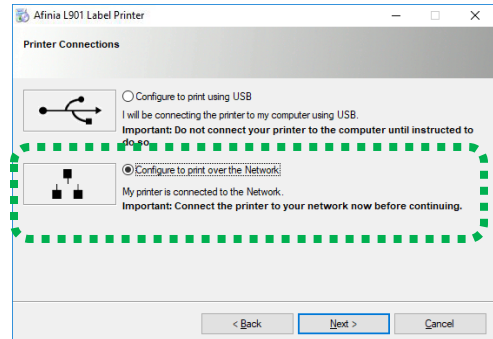

5. Printers Discovered. A list of available Printers opens. Check the **Printer** column to verify you have an **Afinia L901** printer. Check the **Hardware ID** column and match the number listed to the number you copied previously from the Printer label. Select that Printer. Click “Next>”.

NOTE: If the Printer does not appear on the list, the IP address may have to be assigned manually. See “Install Over Network Connection, Method B” on page 14.

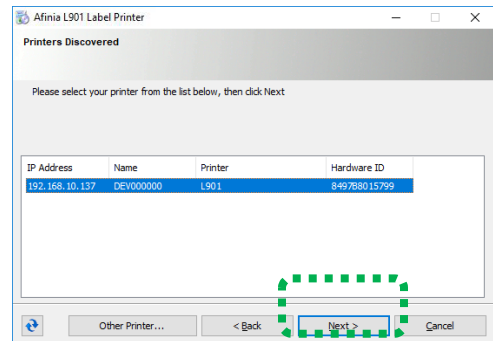

6. Installing Printer Software.

Driver pre-installation begins.

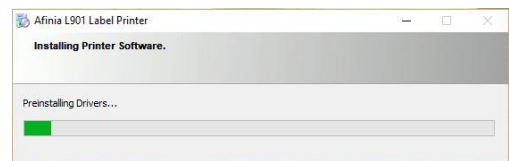

7. Would You Like to Install This Device Software?

Click “Install”.

You may see this message more than once as the drivers are installed.

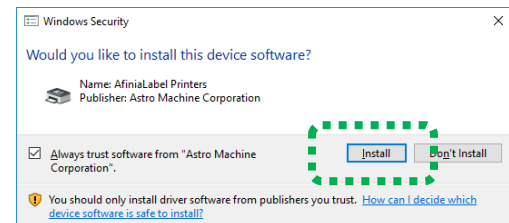

8. Finished software installation.

You can check “Set this printer as the default printer” at this time.

Click “**Finish**”.

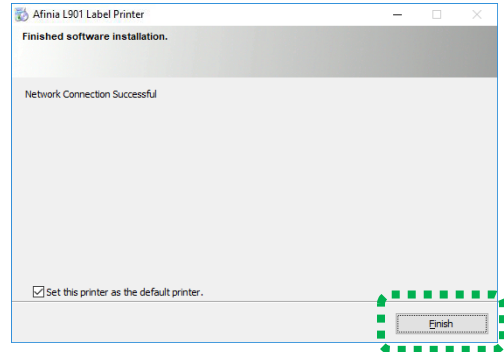

9. Install Driver window.

Click “**Install Driver**” again to install another Printer, or close the Installer.

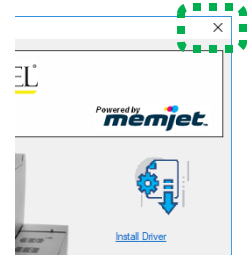

Tip: To help distinguish between multiple Afinia L901 Drivers on your system; open the “**Printers and Faxes**” (*Devices and Printers*) folder and rename the Printers. **For example**, rename a network-configured printer “**Afinia L901 (Network-1)**” and a USB-configured printer “**Afinia L901 (USB)**”.

To open the “Toolbox” utility over an Ethernet (network) connection:

Click **Start, All Programs, Afinia Label, Afinia L901 Driver, Toolbox**.

If more than one copy of the Afinia L901 Driver is installed, you will have to choose which device you want the **Toolbox** to connect to. To help choose the proper device, you can identify the Printer(s) using the **Hardware ID** you copied earlier or you can rename the Printer(s) as outlined in the **Tip** above.

Example:

- Afinia L901 Driver configured for USB:
 - Suggested name “**Afinia L901 (USB)**”
- Afinia L901 Driver (Copy 1) configured for Network:
 - Suggested name “**Afinia L901 (Network-1)**”.
- Afinia L901 Driver (Copy 2) configured for Network:
 - Suggested name “**Afinia L901 (Network-2)**”.

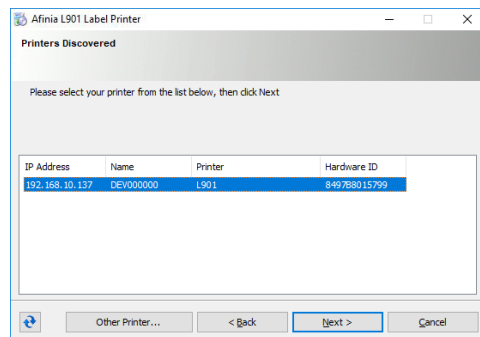

SECTION 2 INSTALLING PRINTER

Method B

Use this procedure to install the Print Driver over the Network connection on **Static IP** systems requiring that an IP address is assigned manually.

NOTE: Copy the 12-digit Hardware ID number listed on the Printer(s) on the label just below Ethernet port so you can identify the Printer(s) in a later step.

1. Install the Printer Software over a USB connection.

This can be done using a nearby computer or laptop. Once the Driver is installed on the Printer, use that same computer to open the **Printer Toolbox**.

2. In the “View” drop-down, click “Service Menus”. The **Service/Diagnostics** screen opens. Click the “System Settings” button. The “System Settings” screen opens. Under “Network Settings” your IT support person can fill in the necessary information (*or you can get it from them*). Click “Submit”.

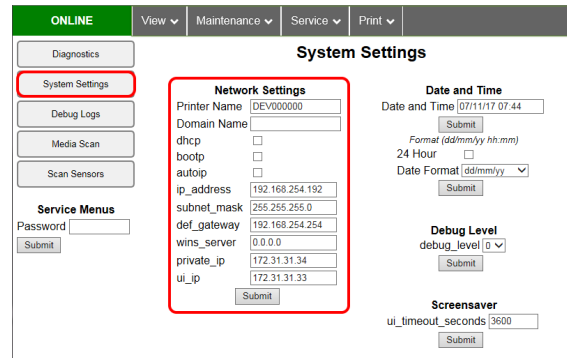
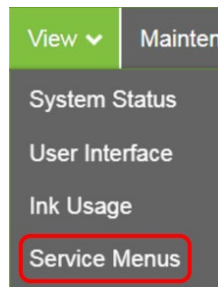

3. Disconnect the USB from the local computer or laptop. If not using that computer for printing, the Afinia L901 Software can be uninstalled.
4. Connect the Ethernet cable to the Ethernet port and rerun the “Install Over Network Connection, Version A” procedure. The Printer should now appear on the “Printers Discovered” window. The Printer can still be identified by its “Hardware ID”, but the new IP address entered by your IT support person (*or operator*) is shown.

Select the desired Printer and click “Next>”. Follow the remaining steps.

5. **Installing Printer Software.**
Driver pre-installation begins.

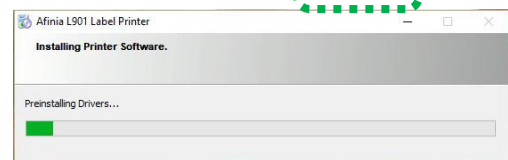
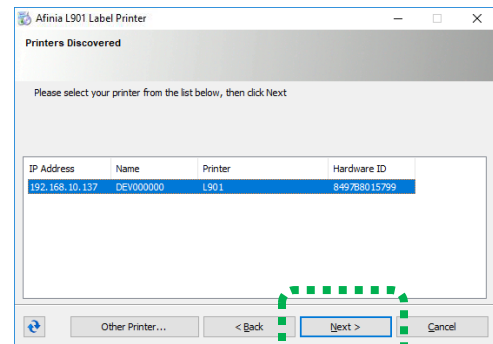

6. **Would You Like to Install This Device Software?**

Click “Install”.

You may see this message more than once as the drivers are installed.

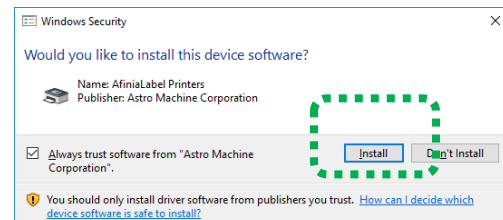

7. **Finished software installation.** You can check “Set this printer as the default printer” at this time.
Click “**Finish**”.

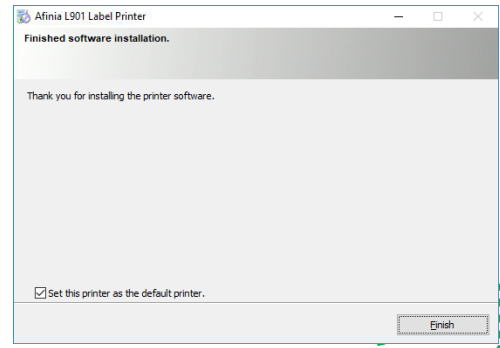

8. Close Installer.

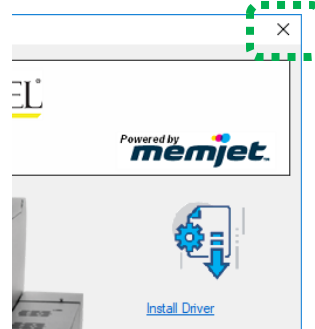

Tip: To help distinguish between multiple Afinia L901 Drivers on your system; open the “**Printers and Faxes**” (*Devices and Printers*) folder and rename the Printers. **For example**, rename a network-configured printer “**Afinia L901 (Network-1)**” and a USB-configured printer “**Afinia L901 (USB)**”.

To open the “Toolbox” utility over an Ethernet (network) connection:

Click **Start, All Programs, Afinia Label, Afinia L901 Driver, Toolbox**.

If more than one copy of the Afinia L901 Driver is installed, you will have to choose which device you want the **Toolbox** to connect to. To help choose the proper device, you can identify the Printer(s) using the **Hardware ID** you copied earlier or you can rename the Printer(s) as outlined in the **Tip** above.

Example:

Afinia L901 Driver configured for USB:

- Suggested name “**Afinia L901 (USB)**”

Afinia L901 Driver (Copy 1) configured for Network:

- Suggested name “**Afinia L901 (Network-1)**”.

Afinia L901 Driver (Copy 2) configured for Network:

- Suggested name “**Afinia L901 (Network-2)**”.

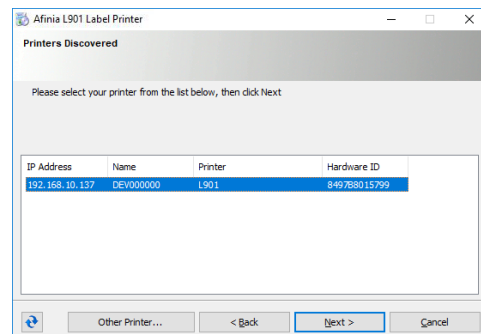

SECTION 2 INSTALLING PRINTER

Install Ink Tanks

Printer uses one Printhead and five Ink Tanks: *two Black, one Cyan, one Magenta, and one Yellow.*

1. Look at the Control Panel Touchscreen.

Ink Tank status information appears in right side of the Touchscreen. Note that the **Ink Tank** indicator boxes are empty. **NOTE:** The question marks indicate that no Ink Tanks are detected by the Printer.

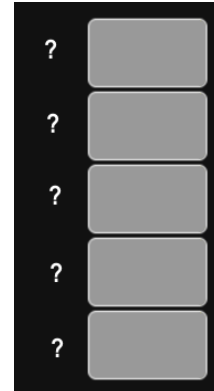

2. Open the Ink Tank Door (*hinged at bottom*). (*Disconnects Printer communication with Ink Tanks and allows safe installation and replacement.*)

Open Ink Tank Latches [A].

3. Remove new Ink Tank(s) from packaging.

4. Insert Ink Tanks (*labels up*) into appropriate color slots [B]. Close Ink Tank Latches – be sure the latches lock in place.

INSTALLATION TIP: Make sure Ink Tanks seat properly. Insert Ink Tank into appropriate Ink Station, then pull Ink Tank back about an inch and push forward firmly to insure that Ink Nozzles penetrate seals on Ink Tanks.

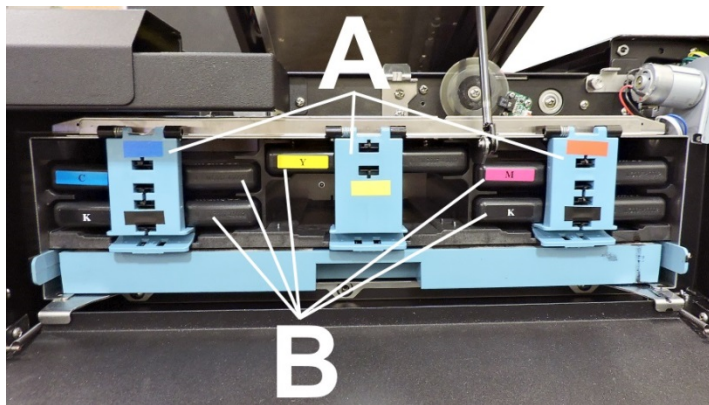

5. Close Ink Tank Door. Ink colors fill in as Ink Tanks are installed. If ink colors do not fill in after a few seconds, open Ink Tank Door again and reinstall Ink Tank(s).

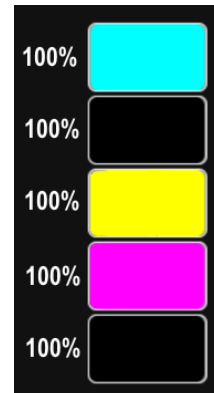

WARNING!

Ink in Ink Tanks may be harmful if swallowed. Keep new and used Ink Tanks out of reach of children. Discard empty tanks immediately.

First Time Install Printhead

The printhead is a delicate precision device. Handle with extreme care to avoid damage and issues that could degrade print quality.

CAUTION
<ul style="list-style-type: none"> • Use electrostatic discharge (ESD) protection when handling. • Hold Printhead by handles ONLY. • DO NOT touch ink couplings, nozzle surface or electrical contacts. • DO NOT unpack Printhead until Printer is ready for installation. Once unwrapped, delay in installing Printhead can compromise print quality due to dehydration. • DO NOT place an unwrapped Printhead on any surface before installing. Protect Printhead from scratches, dust, fibers, dirt and other contaminants at all times.

1. **Open Top Cover.** The printhead latch should be in the open position. If not, on the Touchscreen, open the **Service** dropdown from **Menu**. Press **Release Printhead**. Printer runs, then Latch [1] pops open.

NOTE: Remove Cap Protectors [2] on Ink Nozzles. Be sure to open the Latch fully to retract the Ink Nozzles.

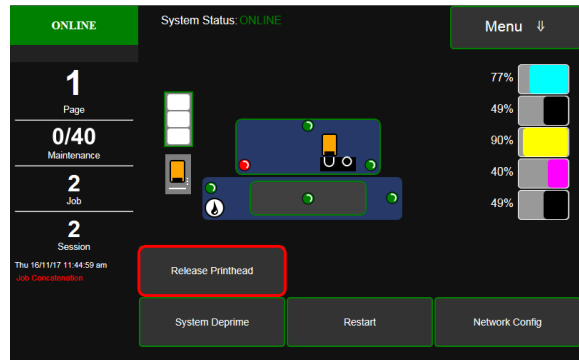
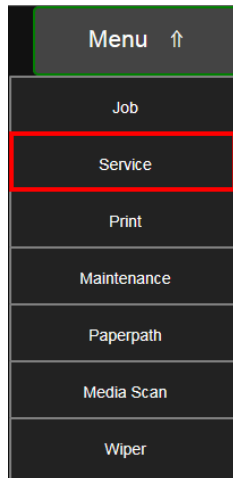

CAUTION
<p>DO NOT PRY OR MANUALLY LIFT THE PRINthead LATCH OR THE LATCH MAY BREAK.</p> <p>ONLY OPEN THE LATCH USING THE RELEASE PRINthead BUTTON ON THE TOUCHSCREEN OR IN THE PRINTER TOOLBOX.</p>

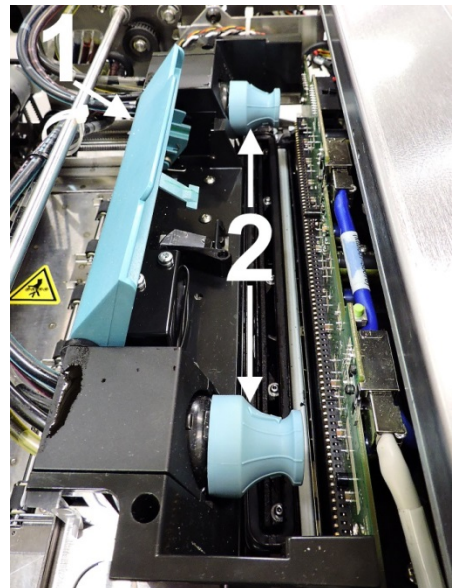

SECTION 2 INSTALLING PRINTER

2. [A] Carefully remove Printhead from foil packaging.

Tear foil at notch or cut the end with scissors.

[B] Remove protective plastic cover. Hold Printhead by handle and unclip cover from Printhead.

[C] Remove protective strip from Printhead Electrical Contacts.

Once removed, DO NOT allow strip to touch electrical contacts.

[D] Remove protective strip from Printhead Nozzles. Hold Printhead by the handle. Pull strip tab and slowly peel strip from Printhead.

DO NOT pull strip at less than a 45° angle from Printhead surface.

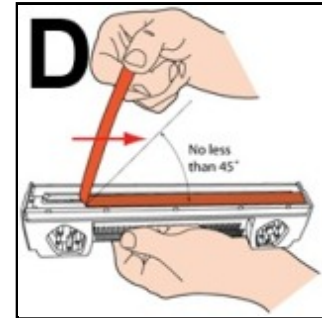
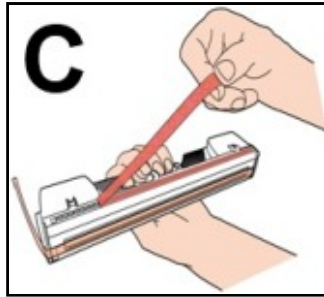
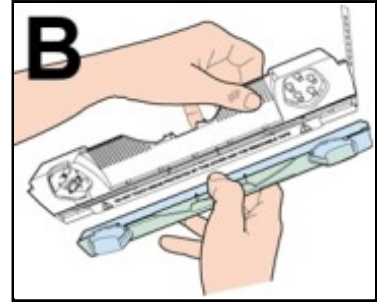
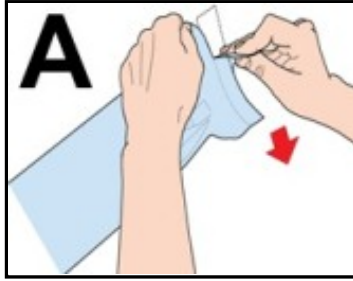

DO NOT allow removed strip to touch Printhead Nozzles.

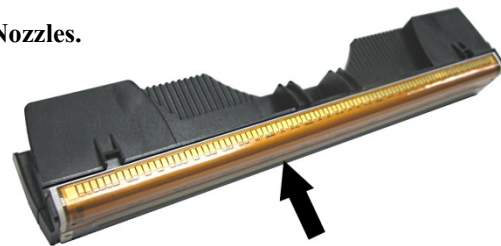

3. Carefully insert Cartridge into compartment at an angle [4], with Printhead surface facing down and Ink Nozzles facing Ink Hoses. Once seated, gently tilt the printhead back until it snaps into an upright position [5].

DO NOT FORCE printhead into position.

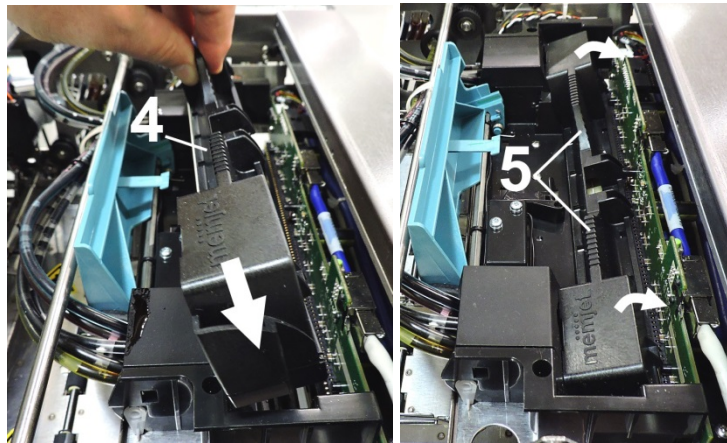

NOTE: See Appendix E for Printhead Best Practices

4. **Close Printhead Latch [6] and Top Door.** Printer starts up and primes ink into Printhead (*this may take a few minutes*). Make sure ink is flowing through hoses.
5. Confirm the missing printhead message is cleared from the touchscreen Status area. Select **Clear Error** if an Ink Cartridge error message appears



6. **Watch the Control Panel Touchscreen.** Check that the Printhead icon [7] in Printer image is primed (*solid color*).
7. When **ONLINE [8]** appears, the Printer is ready for use.

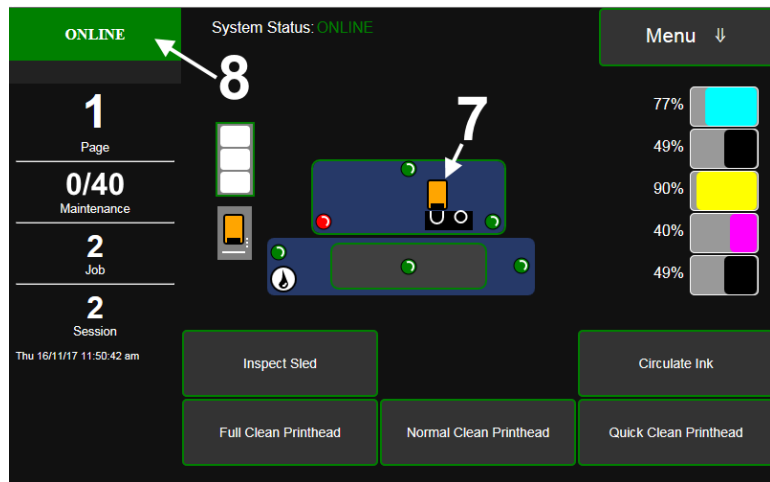

NOTE: If the Printhead icon continues to display an outline or a question mark (?) try the following procedures:

[1] Printhead icon shows an outline (*Printhead unprimed*): Click “Circulate Ink” under “Maintenance” drop-down in Printer Toolbox. If issue persists, try the “Install Printhead” procedure again. If this does not clear up the issue, contact technical support.

[2] Printhead icon displays a question mark (*Printhead not recognized*): Try the “Install Printhead” procedure again. If the issue continues, contact technical support.

NOTE: Printer may take up to 12 minutes to set itself up during initial startup. This is normal.

SECTION 2 INSTALLING PRINTER

Connect Printer to External Device

WARNING!

**HAZARDOUS MOVING PARTS!
KEEP FINGERS AND OTHER BODY PARTS AWAY!**

CAUTION

**MAKE SURE THAT PRINTER IS TURNED OFF
BEFORE CONNECTING EXTERNAL DEVICE.**

Connecting to External Device (Winder, Laminator, etc.):

Connect one end of the interconnect cable into 9-pin connector port on Printer [1] (*located just below USB port*).

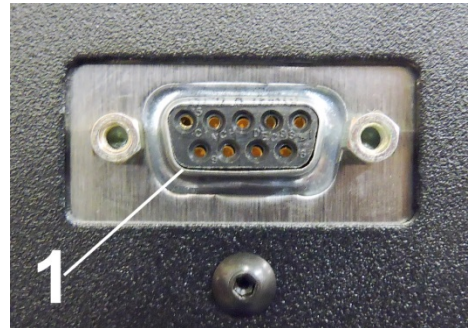

Align External Devices to Printer

If the Afinia Label XL unwinder / rewinder is used, use the included plates to align these devices with the printer.

The plates should be positioned so the feet of the printer are seated in the plate holes.

The label path must be straight to ensure consistent results.

Load Media

Setting the Adjustable Media Sensor.

For irregular-shaped media (*such as a circle*), loosen Sensor Reflector knob. Slide the Sensor Reflector along track so the straight edge of the Sensor [A] aligns with the leading tip of the media [B]. Tighten the knob to lock the Sensor Reflector in place.

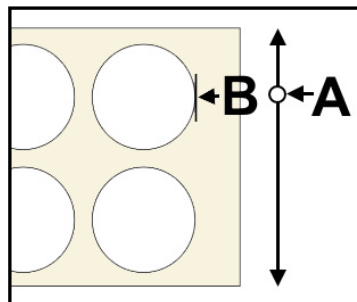
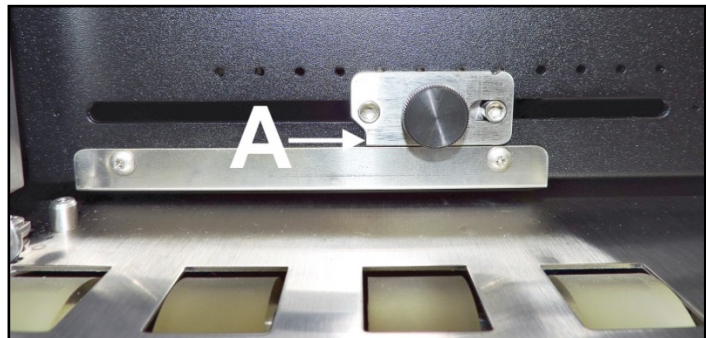

Media Specifications

Media Type and Dimensions	
Label Width	2" to 9" (25.4mm to 228.6mm)
Label Length	2" to Continuous (25.4mm to Continuous)
Label Thickness	0.1mm (Min) to 0.3mm (Max)
Label Minimum Gap	3mm No Bleed (0.125") 6mm Full Bleed (0.25")

No Bleed Label Spec Layout

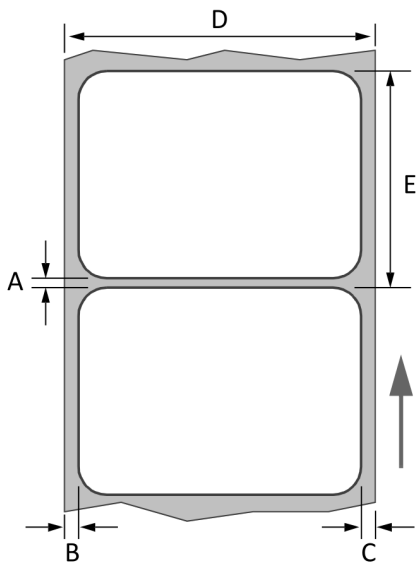

Gap Media (No Bleed)		
	Minimum	Maximum
A	0.125"(3.0 mm)	0.3" (8.0 mm)
B	0.0"	2.0" (50.8 mm)
C	0.0"	N/A
D	2.0" (50.8 mm)	9.0" (228.6 mm)
E	2.0" (25.4 mm)	Continuous

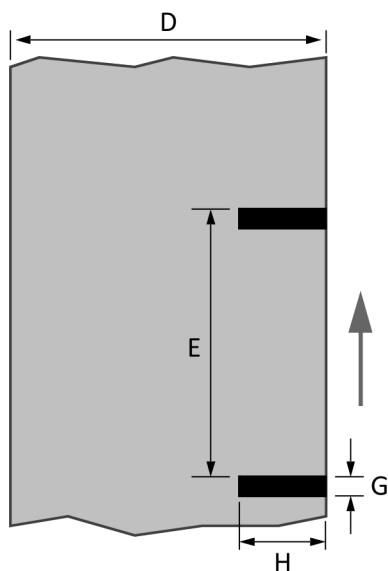

Black Mark Media (No Bleed)		
	Minimum	Maximum
D	2.0" (50.8 mm)	9.0" (228.6 mm)
E	2.0" (50.8 mm)	75" (1905 mm)
H	1.0" (25.4 mm)	9.0" (228.6 mm)
G	0.125"(3.0 mm)	0.3" (8.0 mm)

Full Bleed Label Spec Layout

See Appendices for instructions on Full Bleed Printing

*** Black Mark Labels, when printing with full bleed, should have the matrix still attached to the media.**

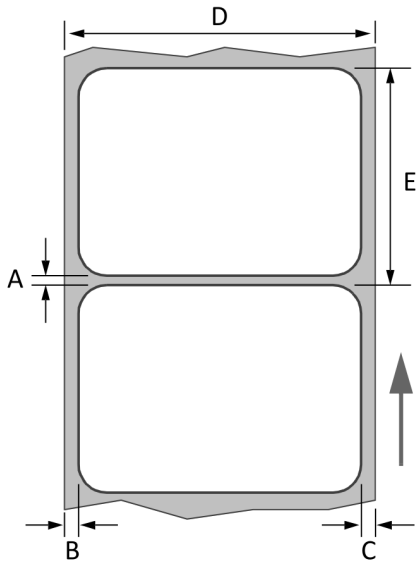

Gap Media (Full Bleed)		
	Minimum	Maximum
A	0.25" (6.0 mm)	0.3" (8.0 mm)
B	0.0625" (1.5 mm)	2.0" (50.8 mm)
C	0.0625" (1.5 mm)	N/A
D	2.0" (25.4 mm)	9.0" (228.6 mm)
E	2.0" (25.4 mm)	Continuous

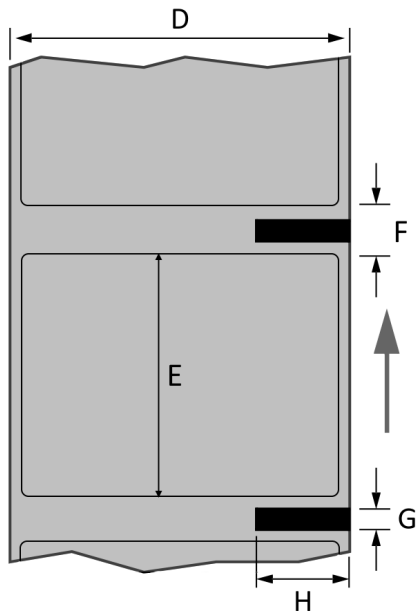

Black Mark Media (Full Bleed)*		
	Minimum	Maximum
D	2.0" (50.8 mm)	9.0" (228.6 mm)
E	2.0" (50.8 mm)	Continuous
F	0.25" (6 mm)	0.3" (8 mm)
H	1.0" (25.4 mm)	9.0" (228.6 mm)
G	0.125" (3.0 mm)	0.125" (8.0 mm)

SECTION 3 – *Operating Printer*

IMPORTANT NOTE: For the best print results, it is recommended that the printer be left turned on. This allows the print head to be serviced on a regular basis, allowing for the best print quality

Once the Printer Driver is installed and the Printhead is primed, you are ready to start printing. Set up your job and send it to the Printer. The Printer will start and print.

Set the **Printer Driver** installed in Section 2 as the default driver. It is then accessible through your applications (such as *Adobe Reader*). Other types of applications and database management software will work in a similar manner when using this Driver.

Printer Driver Properties

The Printer Driver works the same as any other Printer Driver for Windows. It does have some enhancements to help maximize the Printer's ability to print variable addressed pieces quickly and efficiently.

Windows 8, 8.1, and 10: Once job is set up, click **File**, then **Print**. Window at right opens. Make sure the **Afinia L901 Driver** is the selected Printer. Click **Properties** to open the “**General**” Tab window.

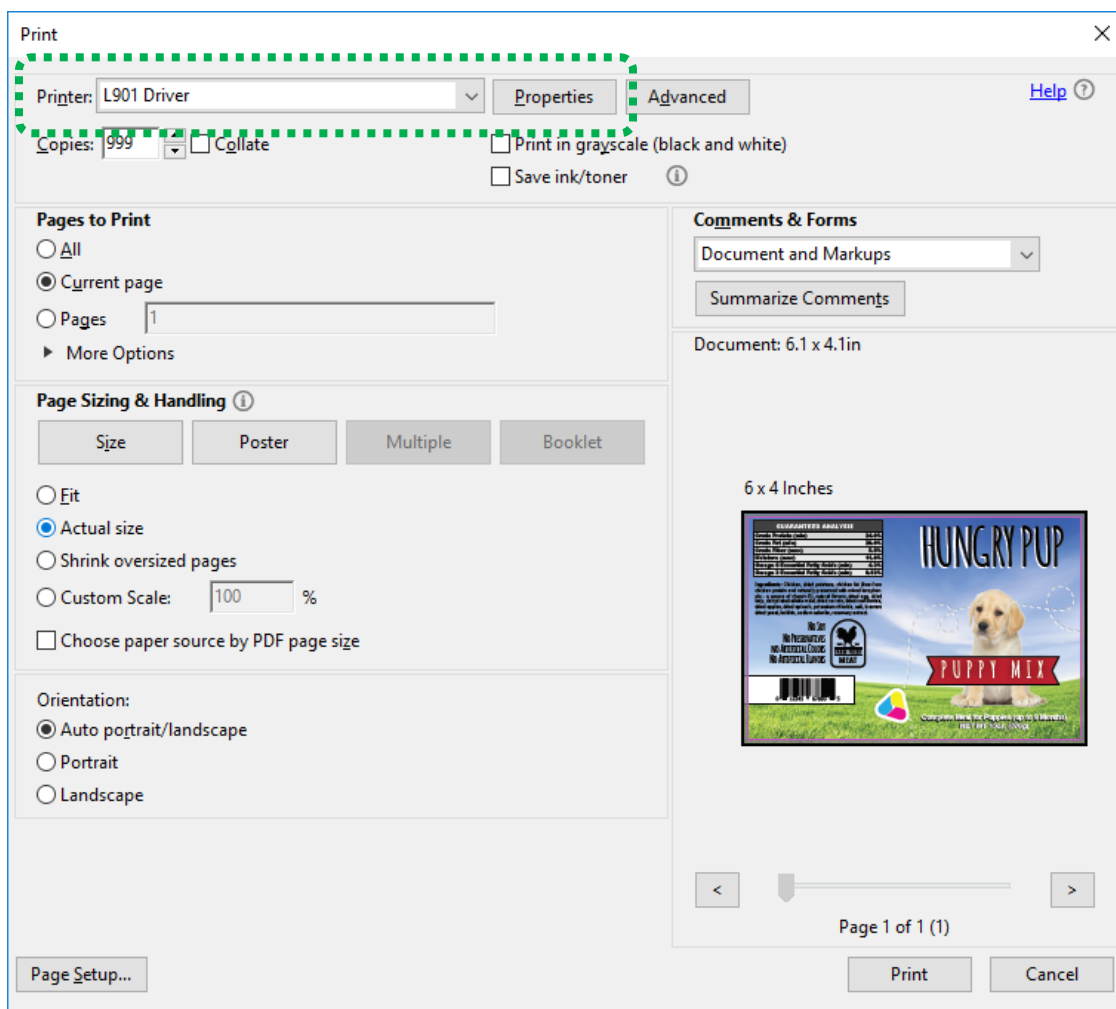

SECTION 3 OPERATING PRINTER

General Tab

General tab lets you select:

- **Orientation** – Set print direction as Portrait (*default*), Landscape, Rotate 180° and Mirrored.
- **Job Management** – **Stitch** is for printing on continuous media (*no gaps*).

Buffer loads entire print job before printing starts. **Mask Optimization** (*checked is default*) optimizes images for printing in most applications.

NOTE: Some applications (*like FlexMail*) may display image boundaries when printed. Unchecking **Mask Optimization** box eliminates these lines (*remember to check box when changing applications*).

Printer Capture – When selected, the Printer stores the print job in the Printer Job Library after the job is printed. Use the **Reprint** button on the printer touchscreen to access the Job Library.

PC Capture – When selected, saves a Print File (*.prn) on the PC (C:\Windows\Temp) for later use (*Unchecked is default*).

NOTE: Use the box below the selection to name the file, otherwise the Printer assigns the current date and a numerical name.

- **Copies** – Enter number of copies to be printed. **Reverse Order:** When box is checked, the job will start printing from the last page of a document and end on the first page.

Collate: When printing multiple copies of multi-page documents, checking the box allows all pages of the document to be printed in proper order before printing the next copy.

- **Media** – Adjusts Printer for media being used for a job.

Type: Choose type of media to be used.

Size: Set a different size media than document was originally designed for. Document is automatically resized to fit new media.

Borderless Printing: Checking this box allows printing to edge of media (*borderless*).

See “[Appendix C – Borderless Printing: Borderless Print vs. Oversize](#)” on page 74.

- **Custom Size** lets you create and save a **Custom Size** to suit your needs.
- **Color Selection** – Set Printing for Color, Composite Black (*uses all colors to print Black*), or Black Only (*uses only Black ink*).
- **Print Quality** – Select **Normal** or **Best**. **Normal** is 1600 x 800 dpi. **Best** setting is 1600 x 1600 dpi, for use when high quality images are required. “**Speed**” allows you to adjust the Printer speed for the media being used (*i.e., slow the printing speed for higher quality on glossy stock*).
- **My Print Settings** – Access saved custom print settings for various jobs.

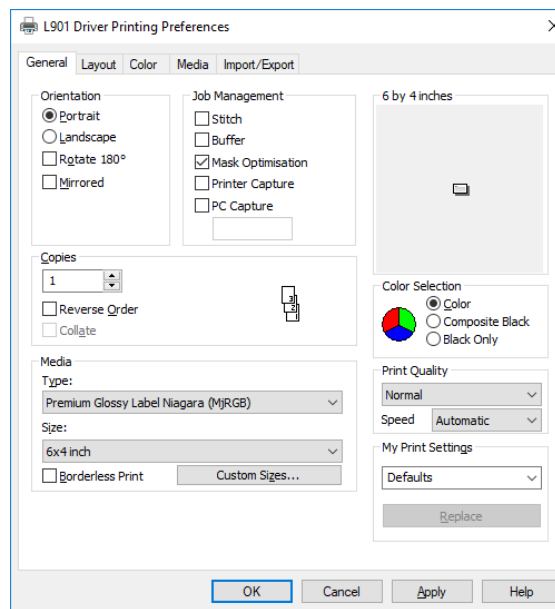

Layout Tab

Layout allows you change how the document prints without changing the original document.

- Resizing** – Specify **Original Size** or **Custom Resize**: Resizes original as a % of normal size. Printer prints document in size you selected regardless of paper size selected.

Print on: Specify a particular size of paper to print on regardless of size of original document. Checking **“Scale to Fit”** automatically resizes document to fit on new page size.
- Watermark** – Prints a light background watermark in paper while printing original document. When selected, **“First page only”** option prints watermark on first page, but not subsequent pages, unchecking prints watermark on all pages. **Custom** button lets you create a new watermark or edit an existing watermark, including font selection, color, size and printing angle.

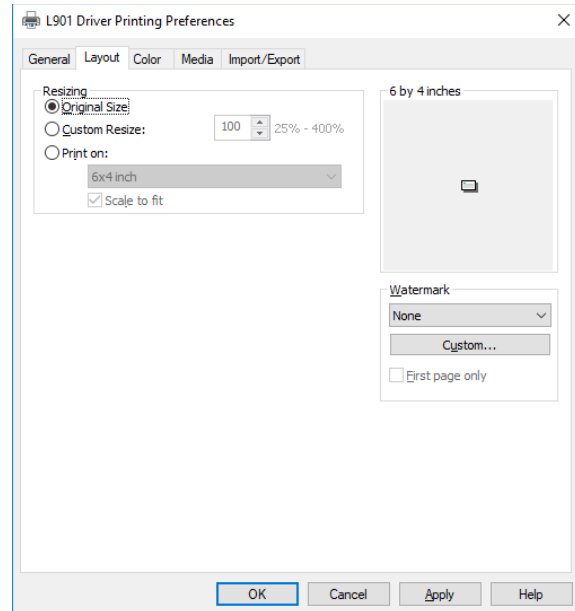

Color Tab

Color is used to adjust the color output of the Printer.

Use the sliders to adjust **Color Tone**, **Brightness** and **Saturation**.

The **C**, **M**, **Y**, **K** sliders adjust individual colors. Use **Defaults** to reset to **0** settings.

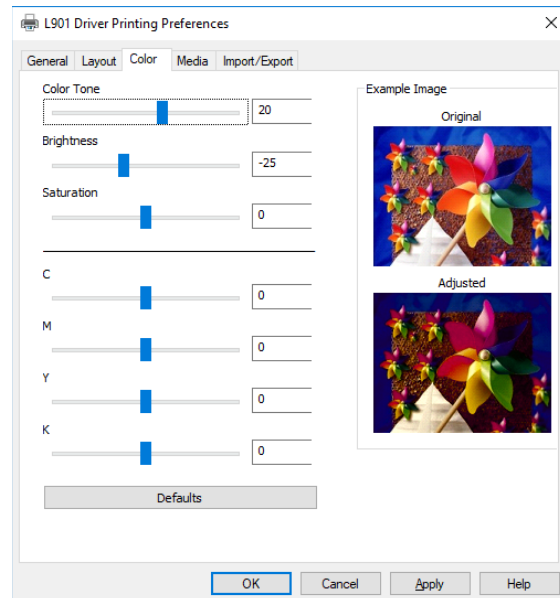

SECTION 3 OPERATING PRINTER

Media Tab

Media Tab shows the the type of media the Printer is configured to run and allows minor changes to the positioning and cutting of the media.

- **Media** – Displays the type of media currently selected for the Printer. Press **Refresh** to update the display.
- **Printing Adjustments** – (*Top, Left and Bottom Adjustments plus Max Page Width and Interpage Gap.*) Make minor positioning changes to the print area in relation to the media if needed.

NOTE: Printing Adjustments only works when Print Area is less than full print width (less than 8.5"/215.9mm wide). See “Using Media Tab Printing Adjustments” on next page.

Stitch – When selected, prints the entire document as a single page (*no gaps*).

Label Frequency – Allows Printer to ignore a set number of gaps between labels. This is particularly useful when the labels are different shapes and the Printer sensor may not sense the edge of second label correctly. (*For example, printing both front and back bottle labels in one pass.*) A label frequency of “1” reads the gap between every label. A setting of “2” will ignore the gap between the two labels [A]. (*In effect, the Printer “sees” the two labels as one label*). The **Label Frequency** can be set from 1-8.

NOTE: Using this feature requires that the job be set up as one label in the layout software, so dimensions (including gap) must be accurate.

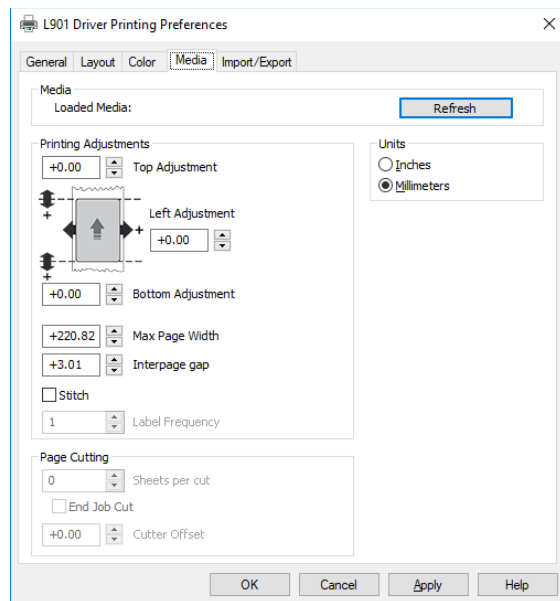

Example of a Label Frequency of “2”

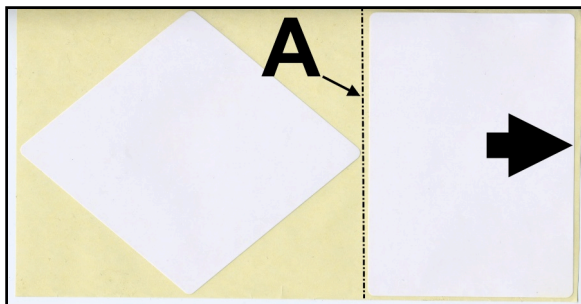

- **Page Cutting – Sheets per Cut:** Set the number of labels (*sheets*) between cuts. **Example:** 1 = cut after every label. 5 = cut after every fifth label. **NOTE:** Since **End of Job Cut** will also be active, last cut may have fewer labels than set **Pages per Cut** number depending on total number of labels you are printing (*i.e. you print a total of 23 labels set to cut after every fifth label, you will have 4 sets of 5 labels, 1 set of 3.*)

End Job Cut: When checked, cuts the end of the media after the job finishes printing.

Cutter Offset: Allows fine tuning of the cut line position after making image positioning adjustments.

- **Units** – Set measurements to be in Inches or Millimeters.

Using Media Tab Printing Adjustments

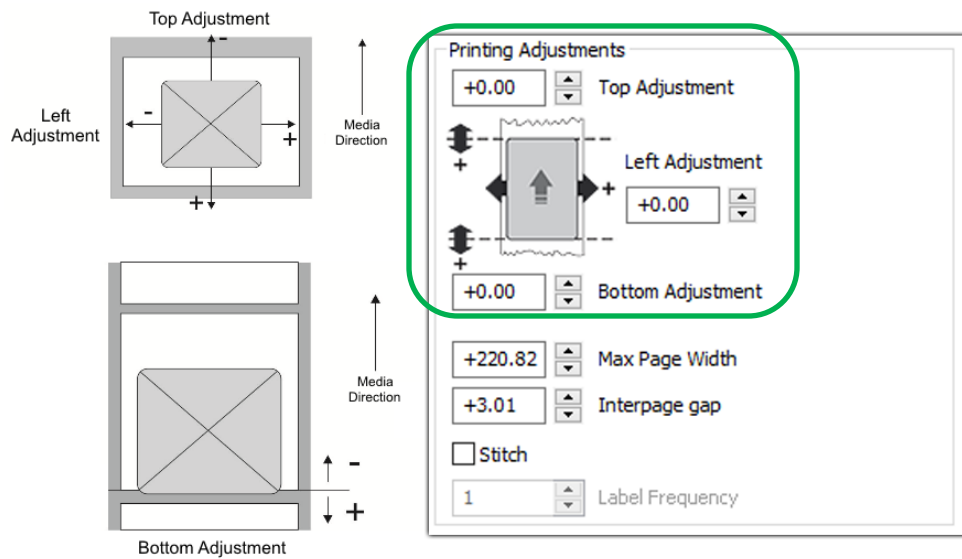

Top Adjustment/Top of Form (TOF) – Moves image up or down (*-5mm up to +200mm down*) from top left corner of media used.

Left Adjustment moves image area away (*-3mm left to +200mm right*) from left edge of media. (*0.1mm increments*)

Bottom Adjustment /Bottom of Form (BOF) – Extends BOF (*in 0.1mm increments*) to allow printing over edge of a label (*full bleed label printing*).

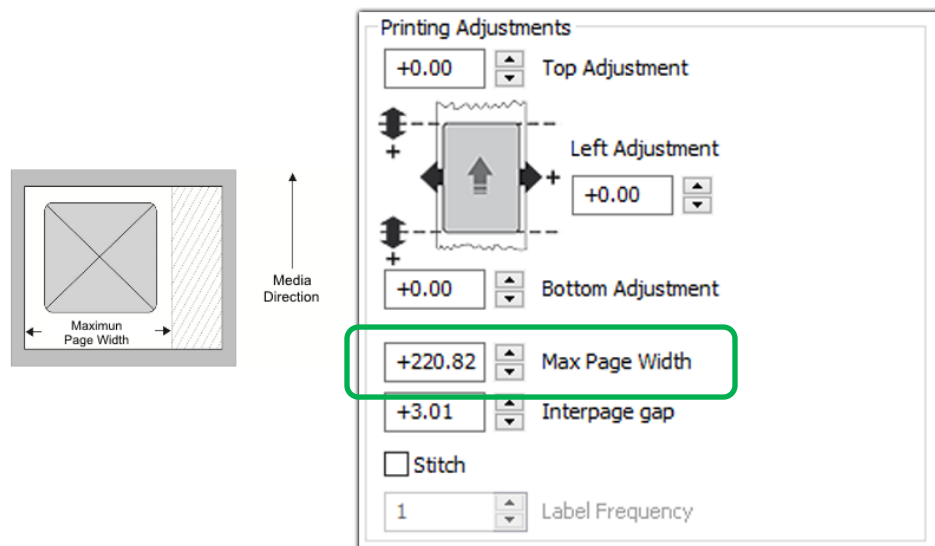

Max Page Width – Sets width of actual print area. (*0.1mm increments*) This shuts off nozzles in non-printing area (*not used for printing*) and saves ink.

NOTE: Can be no larger than maximum print width for Printer (8.5"/215.9mm).

Interpage Gap – Sets a gap between labels (*pages*) when using continuous media. **NOTE:** Minimum gap (*default*) is 3mm.

SECTION 3 OPERATING PRINTER

Import/Export Tab

Import/Export is used to preserve any custom **Watermarks, Media Sizes, and/or Print Settings** you may have developed and saved for various jobs when you update Printer firmware or drivers.

- **Export** – Send custom settings to a holding file before downloading new firmware.
- **Import** – Return custom settings after firmware installation is complete.

IMPORTANT!

BEFORE UPDATING PRINTER FIRMWARE OR DRIVERS, REMEMBER TO FIRST EXPORT ANY CUSTOM MEDIA SIZES, WATERMARKS OR PRINT SETTINGS YOU HAVE ADDED TO AN OUTSIDE HOLDING FILE. THIS PREVENTS THE LOSS OF YOUR CUSTOM SETTINGS.

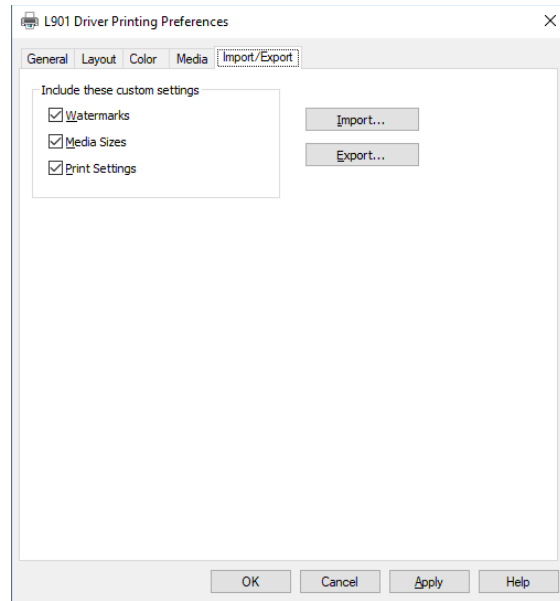

Using Printer Touchscreen

Once the Printer Driver is installed, and the Printer is turned ON, you can use the **Printer's Touchscreen**. You can check Printer status, monitor ink usage, perform diagnostic checks, print reports and run maintenance tasks on the Printer from the Touchscreen. **NOTE:** These functions and more can also be operated remotely from a computer using the **Printer Toolbox**. See “**Using Printer Toolbox**” on page 40.

Tap the screen to view the **Printer Touchscreen**.

- [A] System Status Indicator (*at top of screen*)
- [B] Drop-Down Menu Options (*at top of screen*)
- [C] Check Printer Status (*across middle of screen*)
- [D] Three often-used control buttons (*at bottom of screen*)

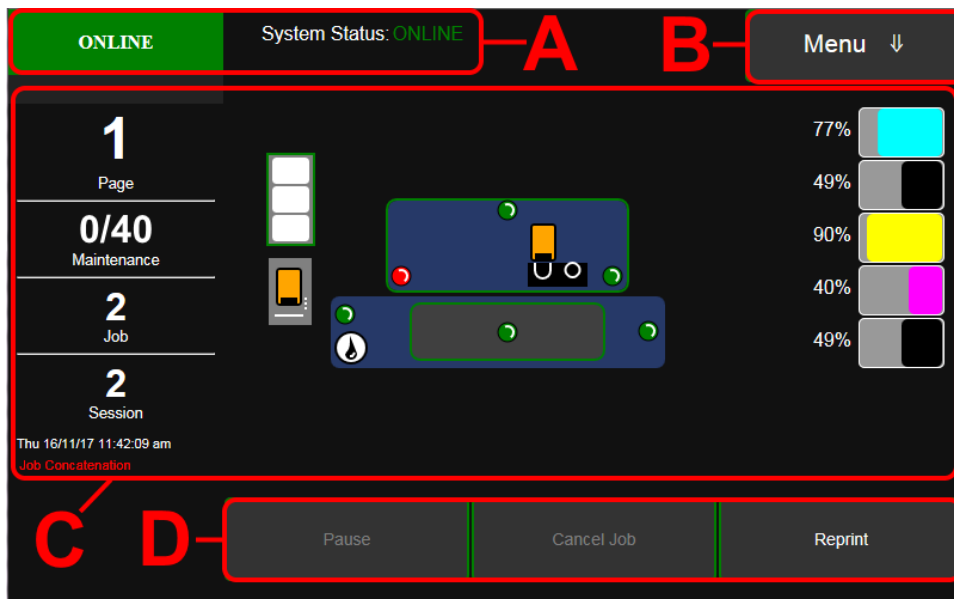

Drop-Down Menu Options

The **Menu** drop-down gives you seven selections: **Job, Service, Print, Maintenance, Paperpath, Media Scan** and **Wiper**.

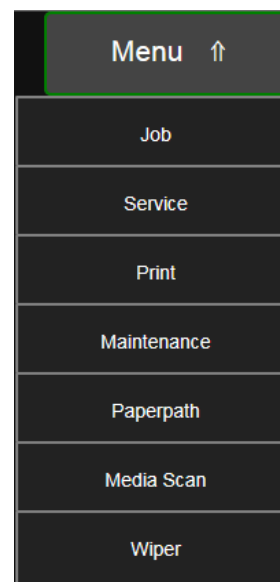

SECTION 3 OPERATING PRINTER

Job (Status Screen)

The opening screen provides information about the status of the Printer.

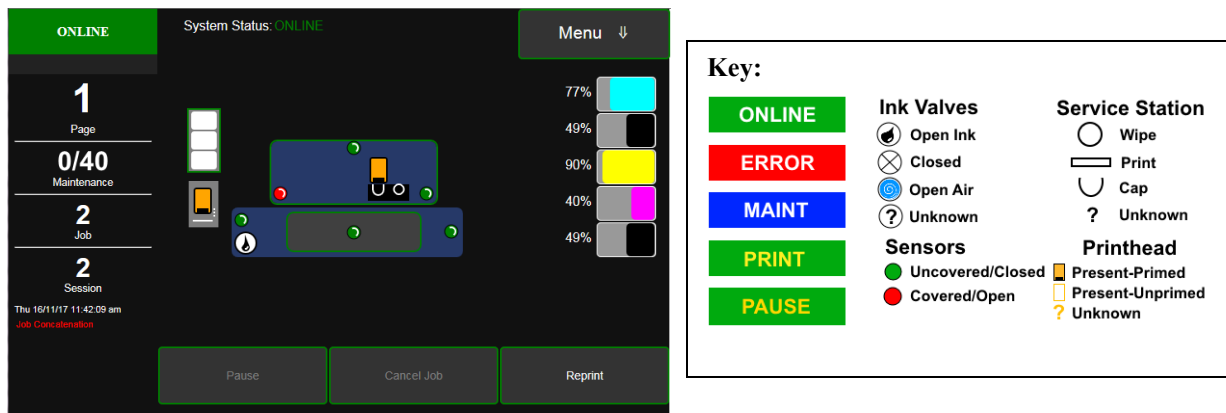

Status Indicator box shows Printer activity as **ONLINE**, **ERROR**, **MAINTENANCE**, **PRINTING** or **PAUSED**. The gray box (*below Status Indicator*) shows the name of the job being processed.

System Status displays current status of Printer and/or error message.

Page shows the page count for a given job.

Maintenance counts down from a specified preset length of printed media until the next automatic Printhead maintenance is performed by the Service Station. **NOTE:** Select the length by opening the Printer Toolbox **User Interface** screen, **Mid-Job Servicing**. In this example, service is performed every 40 meters (131-ft.).

Job shows number of jobs printed (*resettable*).

Session shows the total number of pages printed (*resettable*) over the length of a Session (*shift, day, week, etc.*).

Date and Time shows current date and time. These can be configured and set by opening the **Service** screen, then **Network Config**, then **Date and Time**.

Printer Messages may appear under **Date and Time**.

Media Icon: Displays the type of media the Printer is currently configured for – **Continuous**, **Diecut** or **Black Mark**. Set the type of media by tapping the icon and selecting the appropriate media type or using the **Media Scan** function after selecting **Service** from the **Menu** dropdown.



Printhead Height Icon: Shows current Printhead printing height setting (*3 dots = Low, Normal, High settings; Set in Toolbox User Interface screen, Print Height*)

Printer Icon: Shows status of Media Sensors located in the media feed path of the Printer. Also shows status of Ink Valves, Service Station, and Printhead. These can alert the operator to the type and location of a problem (*see icon key above*). Tapping any of the status icons pops up a description of that icon.

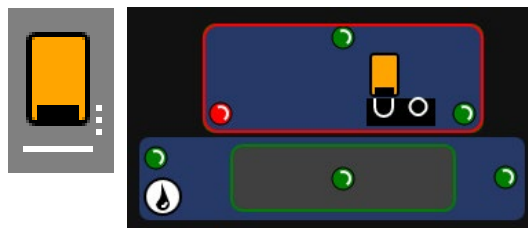

Ink Levels displays percentage of ink remaining in each of the Ink Tanks.

CONTROL BUTTONS (*located along the bottom of the screen*): Provide quick access to often-used functions.

Pause: Tap to temporarily stop printing. Tap again to resume printing.

Cancel Job: Cancels a job from the printing queue.

NOTE: Cancelled jobs must be reloaded before printing can resume.

Reprint: Opens the Printer's Job Library to access print jobs saved in the Printer's memory. You can also make changes to the job specifications and delete jobs as needed.

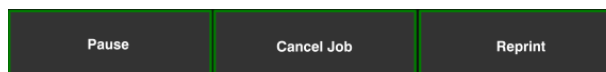

Using Reprint (Print Job Library)

Print jobs can be saved to the Printer's **Job Library** by selecting the **Printer Capture** option under **Job Management** on the **General Tab** of the **Printer Driver**. You can access jobs saved in the Printer's **Job Library** using the **Reprint** button on the **Jobs Screen**. **NOTE: If no jobs are saved on the Printer, this button will be inactive.**

To view the Printer's **Job Library**, press **Reprint** on the **Jobs Touchscreen**. The **Jobs Library** opens.

Use the **View** button [A] to toggle the Library view between Thumbnail and List.

Use the **Search** icon [B] to search for a particular print job.

The **Exit** button [C] returns you to the **Jobs (Status)** screen.

The **Printer** icon [D] prints the selected job.

The **Trashcan** icon [E] (*List view only*) deletes selected job(s) (*checked in the Delete column in the Jobs List*) from the Library.

The **Disk** icon [F] displays the available space left in the Printer's Job Library memory.

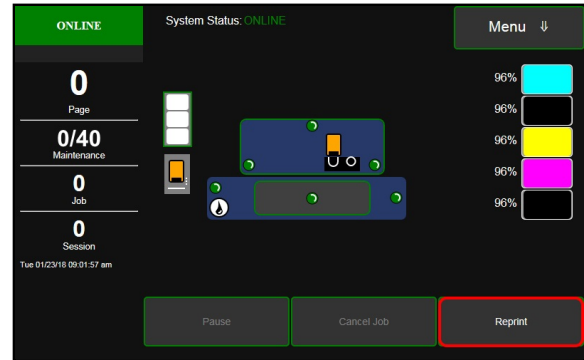

Thumbnail View

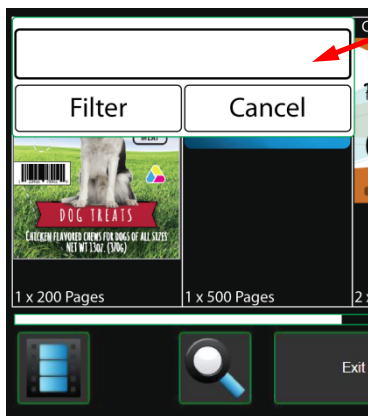
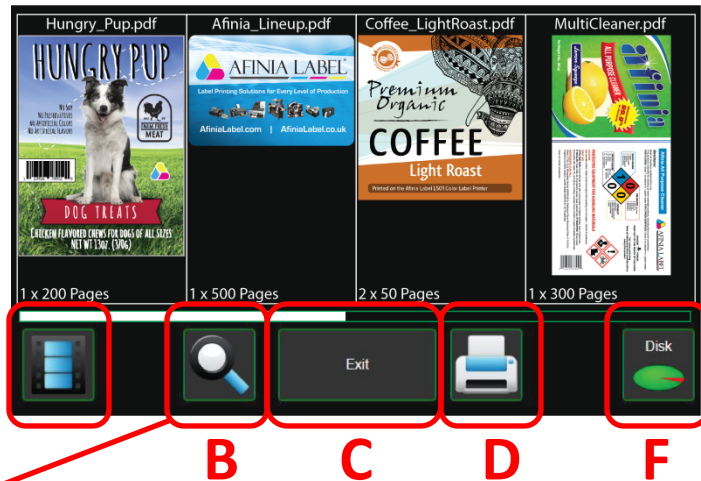

List View

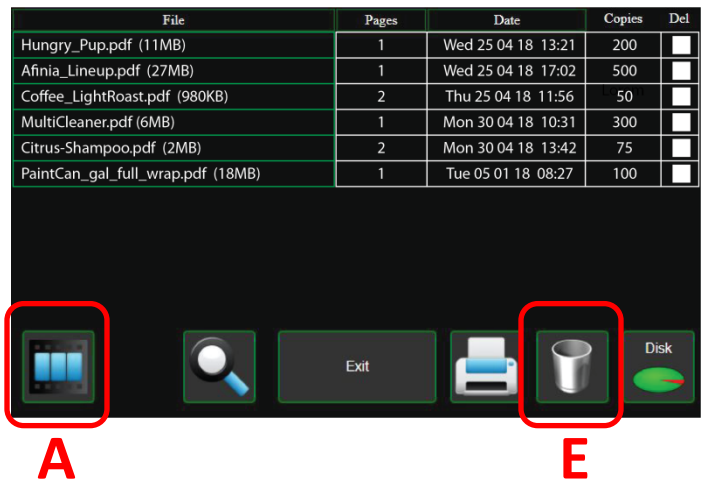

SECTION 3 OPERATING PRINTER

Select a job by tapping the job icon or the list name. The **Job Print Options** screen opens.

The (4) **Control** buttons let you **Exit**, **Print**, **Save** or **Delete** the print job. The **Save** button saves any changes you make to the job specifications in the **Print Options** on the right side of the screen. If you do not tap **Save**, the print job reverts to its original settings when you **Exit**.

The **Print Options** allow you to change or adjust print specifications for the print job. Scroll down the screen to access all options.

Quality – Tap the button to select **Normal** or **Best**. **Normal** is 1600 x 800 dpi. **Best** setting is 1600 x 1600 dpi.

mm or **inches** – Tap the button to change measurements to millimeters or inches.

From page and **To page** – Select the first and last pages of a job (*or part of a job*) to print using the Up or Down arrows.

Copies – Enter the number of copies to be printed.

Left Adjustment – Moves the image area away (-3mm left to +200mm right) from the left edge of the media. (*Up or down arrows move in 0.1mm increments*)

Max. Page Width – Sets the width of the actual print area. (*Up or Down arrows move in 0.1mm increments*) This shuts off nozzles in the non-printing area (*not used for printing*) and saves ink. **NOTE: Can be no larger than maximum print width for Printer (8.5"/215.9mm)**

SCROLL DOWN USING THE BAR ON THE RIGHT TO SEE MORE SETTINGS

Top Adjustment – Moves Top of Form (TOF) image up or down (-5mm up to +200mm down) from top left corner of media used.

Bottom Adjustment – Extends Bottom of Form (BOF) (*in 0.1mm increments*) to allow printing over the edge of a label (*full bleed label printing*).

Interpage Gap – Sets a gap between labels (*pages*) when using continuous media. **NOTE: Minimum gap (default) is 3mm.**

End Job Cut – When checked, cuts the end of the media after the job finishes printing.

Sheets Per Cut – Set the number of labels (*sheets*) between cuts. **Example:** 1 = cut after every label. 5 = cut after every fifth label.

NOTE: Since **End of Job Cut** will also be active, last cut may have fewer labels than set **Pages per Cut** number depending on total number of labels you are printing (*i.e. you print a total of 23 labels set to cut after every fifth label, you will have 4 sets of 5 labels, 1 set of 3.*)

Normal Speed – Adjust the Printer speed for the **Normal Quality** setting and for the media being used (*i.e., slow the printing speed for higher quality on glossy stock*).

Best Speed – Adjust the Printer speed for the **Best Quality** setting and the media being used (*i.e., slow the printing speed for higher quality on glossy stock*).

Cutter Offset – Allows fine tuning of the cut line position after making image positioning adjustments.

Label Frequency – Allows Printer to ignore a set number of gaps between labels. This is particularly useful when the labels are different shapes and the Printer sensor may not sense the edge of second label correctly. (*For example, printing both front and back bottle labels in one pass.*) A label frequency of “1” reads the gap between every label. A setting of “2” will ignore the gap between the two labels [A]. (*In effect, the Printer “sees” the two labels as one label*). The **Label Frequency** can be set from 1-8.

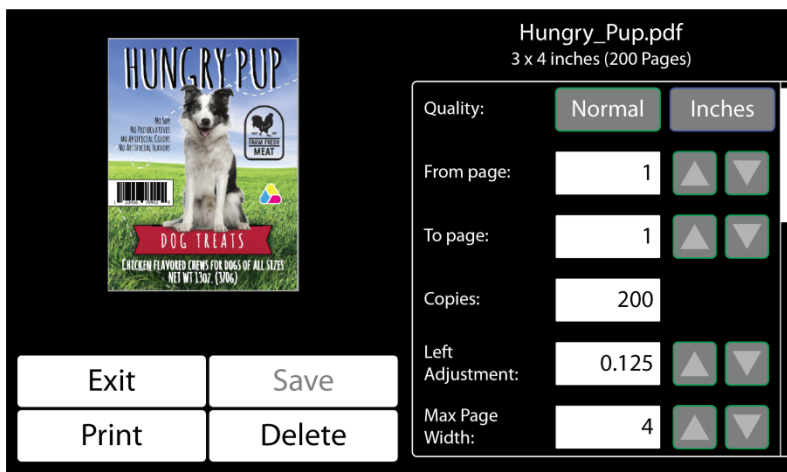

Service Screen

Tap the **Menu** button, then **Service** button to open the **Service** screen.

Release Printhead – Pumps ink back into Ink Tanks and opens Printhead Latch to remove or install Printhead.

NOTE: Button is only active if the system is deprimed first.

System Deprime – Pumps ink back into Ink Tanks prior to replacing the Printhead or transporting the Printer.

Network Config button. Click to view, enter or change settings to connect the Printer to your network. You can also set the **Screensaver Timeout** (*sleep delay*) and **Printer Date and Time** (*see System Settings in Using Printer Toolbox on page 46*).

Restart – Restarts the Printer without having to perform the normal shutdown routine.

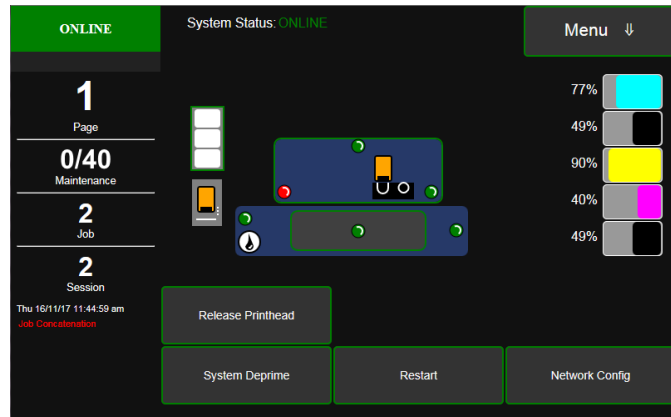

Network Configuration			
Printer Name	DEV000000	Domain Name	
IP Address	192.168.254.190	Private IP	172.31.31.34
Subnet Mask	255.255.255.0	UI IP	172.31.31.33
Default Gateway	192.168.254.254	WINS Server	0.0.0.0
<input checked="" type="checkbox"/> <input type="checkbox"/> <input checked="" type="checkbox"/> <input type="checkbox"/> <input type="button" value="Submit"/>			
Screensaver		Date and Time	
Timeout	600		01/23/18 9:13 AM
<input type="button" value="Submit"/>		<input type="button" value="Submit"/> <input type="button" value="Cancel"/>	

Print Screen

Tapping **Menu**, then **Print** opens the **Print** screen options for printing different reports.

NOTE: 8.5" wide continuous stock required for these four prints.

Print Color Bars – Prints a series of 7 color bars (*per Printhead*) to indicate how well Printheads are mixing colors and printing.

Print Setup page – Prints a printing pattern used for positioning image on the page.

Print Configuration – Prints current Printer configuration including Firmware Version, Network Connection, Printer Serial Number and more for Printer.

Print Printhead Test – Prints color bands, text and patterns to check condition of the Printhead ink nozzles.

NOTE: Uses less ink than Print Color Bars.

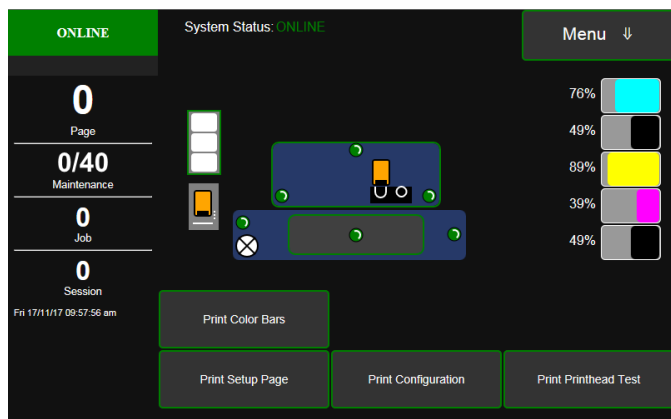

SECTION 3 OPERATING PRINTER

Maintenance Screen

Tapping **Menu**, then **Maintenance** opens the **Maintenance** screen. These buttons operate functions for Printer and Printhead maintenance.

Inspect Sled – Moves Service Station out from under the Printhead Assembly for inspection, cleaning or service.

Circulate Ink – Purges air from ink lines and primes system after replacing the Ink Tanks or the Printhead.

Full Clean Printhead – Runs cleaning routine multiple times for the most thorough flushing and cleaning of the Printhead.

Normal Clean Printhead – Runs cleaning and wiping routine twice for a thorough flushing and cleaning.

Quick Clean Printhead – Circulates ink; wipes and cleans Printhead.

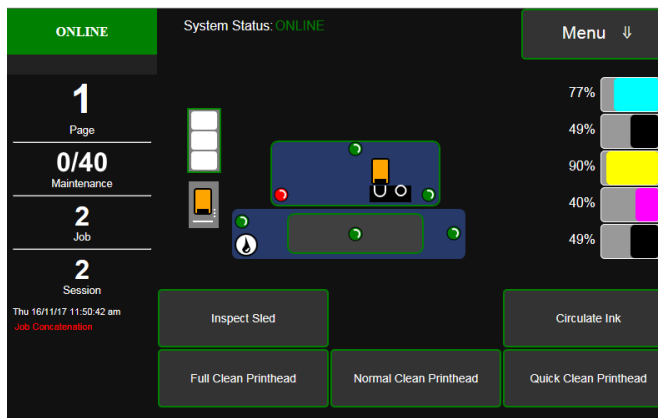

Paperpath Screen

Tapping **Menu**, then **Paperpath** opens the **Paperpath** screen. These buttons are used to move media through the Printer when loading or unloading the Printer.

Unload – Rewinds the media back onto the Unwinder and into the Start position on the Printer.

NOTE: For Diecut and Black Mark media, Unload will rewind stock one label at a time; may need to press Unload more than once.

Cut – Tap to cut the roll. The **Cut** button may change to **Cut Position** – In this instance, pressing the button advances the last printed label past the Cutter, then roll is cut and the media retracts to the Start position.

Load – Moves the media from the Unwinder and into the Start position.

Reverse Arrow – Moves media back onto the Unwinder. Pressing once moves media at slow speed, pressing again moves media at faster speed.

Stop – Stops the media from either advancing or rewinding.

Forward Arrow – Moves media forward through the Printer and onto the Winder. Pressing once moves media at slow speed, pressing again moves media at faster speed.

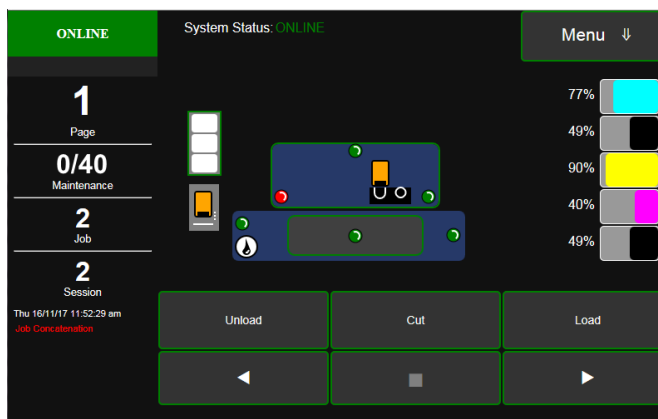

Media Scan Screen

Tapping **Menu**, then **Media Scan** opens the **Media Scan** screen.

Use **Media Scan** to fine tune sensor sensitivity and/or adjust scan length if media is not printing correctly, or to determine if a type of media is going to have problems printing. This is generally due to the sensors having trouble differentiating between the label surface and backing/gap. (See *Using Media Scan* below).

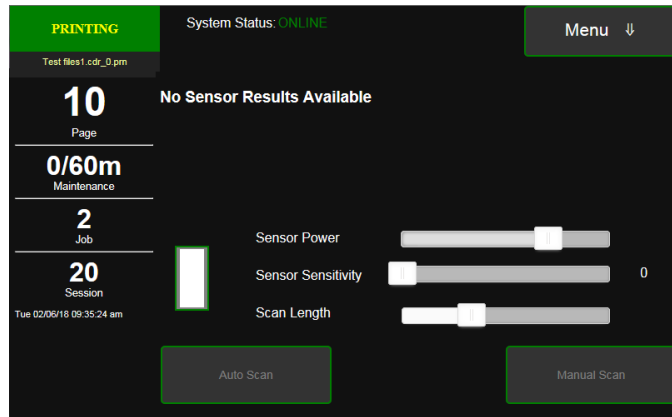

NOTE: If using notched Tags, open the Top Cover and slide the white magnetic strip [A] back to uncover the See-Thru Sensor [B]. Cover the Sensor for all other media.

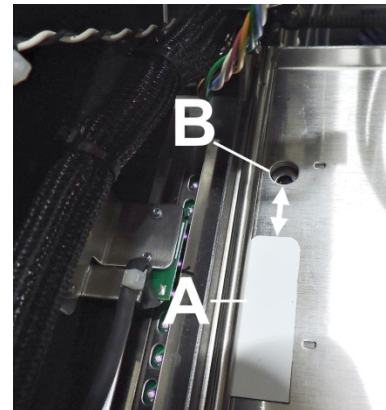

Using Media Scan

1. Tap **Menu**, then **Media Scan**. **Media Scan** screen opens.
2. Tap the **Label Icon** to select the type of label being used (*diecut or black mark*).
3. Set the **Scan Length** bar slider (*set in mm in this example*) so the length would include at least 4 or 5 labels.
4. Load media in the Printer.

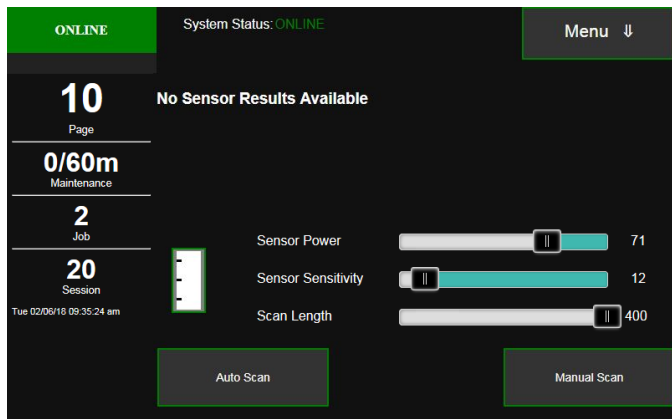

SECTION 3 OPERATING PRINTER

5. Tap **Auto Scan**. The Printer will feed media in both directions a few times.

When the scan is complete, the Touchscreen will show the best Sensor Power determined by the scan and display a graph of the scan, with results marked **Legend** and **Edge Distances**.

The **graph** shows the difference between the high points (*gaps/backing*) and flats (*label media*). If there is little difference between the highs and the flats, the Printer may have trouble differentiating the labels from the gaps.

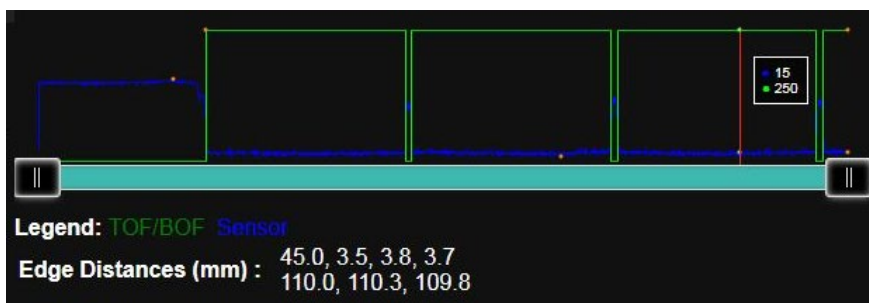
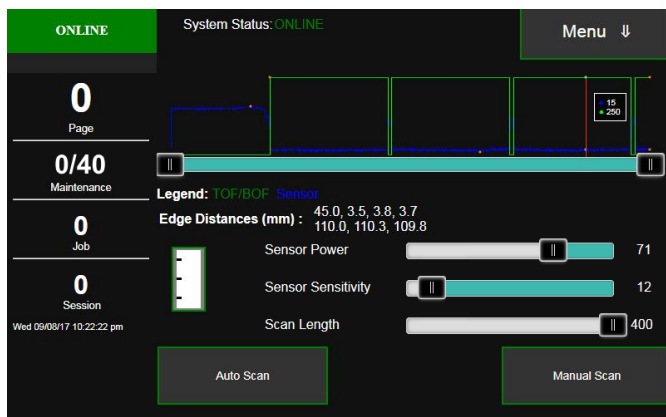

Legend explains what the graph is showing. **Media** (TOF/BOF-Green line) and **Sensor** (Sensor-Blue line).

Edge Distances:

- **Top line** shows the average gap distance reading.
- **Bottom line** shows the length of the label reading.

This example uses a 1/8" (3.5mm) black mark or gap with a 4" (101.6mm) long label.

6. If the scan doesn't return any results, manually increase the Sensor Power by small increments and press **Auto Scan** again. You can continue to make adjustments and rescan until the readings closely match the desired media gap and length.
7. **Manual Scan** is an advanced user method, with the Sensor Power being set by the end user to make fine adjustments to the sensors. Unlike Auto Scan, Manual Scan will not change the Sensor Power based on the scans of the label stock. Setting ranges are:

Sensor Power: 0 to 100

Sensor Sensitivity: 0 to 100

Scan Length: 0 to 400mm

Change the **Sensor Power** and **Sensitivity** by very small increments.

NOTE: **Media Scan** is also available in the **Toolbox** on the computer. (See *Media Scan in Using the Toolbox* on page 47).

Wiper Screen

Tapping **Menu**, then **Wiper** opens the **Wiper** options screen. Selections are **Wiper Transfer**, **Condition Wiper** and **New Wiper**.

Wiper Transfer – Manually initiates a Wiper Transfer instead of waiting for a Transfer to automatically occur during normal operating cycles. Squeegees excess ink off of the Service Station Wiper Roller.

Condition Wiper – Re-saturates, conditions, and cleans the Wiper Roller with ink to remove dried residue if the Printer has been left inactive for long periods of time.

New Wiper – Initiates a **System Deprime**. Moves Service Station out to remove and replace the Service Station Wiper Roller. Once the new Wiper is installed, the Printer primes the system with ink and conditions the Wiper to optimal operating condition.

1. Printer runs a **System Deprime**
2. Replace Wiper Roller or Wiper Module
3. **Finish button**: System primes with ink and **Condition Wiper** runs

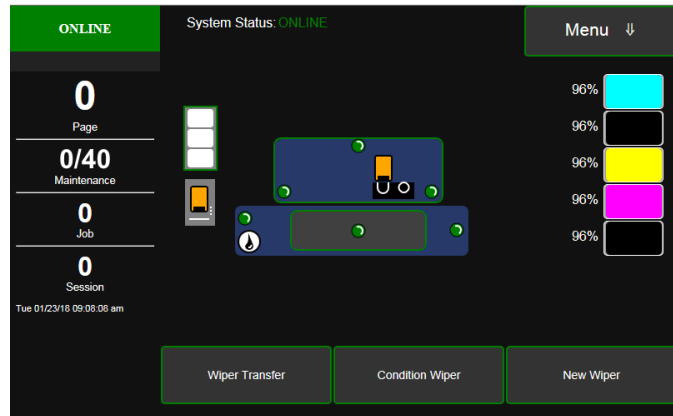

System Test

NOTE: These tests should only be performed by authorized service personnel.

1. **System Test** allows testing individual or all Printer systems listed to check that they are operating within specifications. It also allows service people to check the Printer after servicing or replacing parts, particularly belts.
2. Tap **Menu**, then **System Test** to open the **Password** screen. Enter the password and tap "**Submit**" to open the **System Test** screen.
3. **NOTE: Prior to running the System Test make sure no media is loaded in the Printer and there are no obstructions in the media path.**

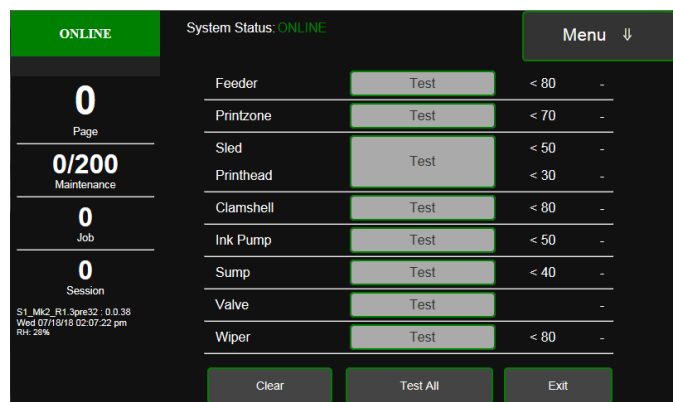
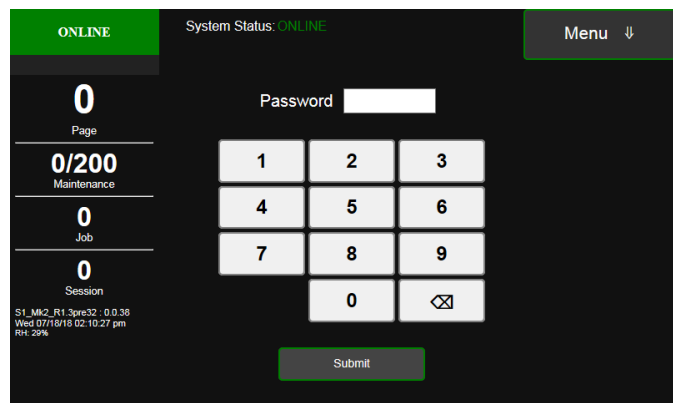

SECTION 3 OPERATING PRINTER

Using the USB Back-Up Port

The USB Back-up Port can be used to back stored print jobs, upload print jobs directly to the Printer, or backup any debug logs currently on the Printer.

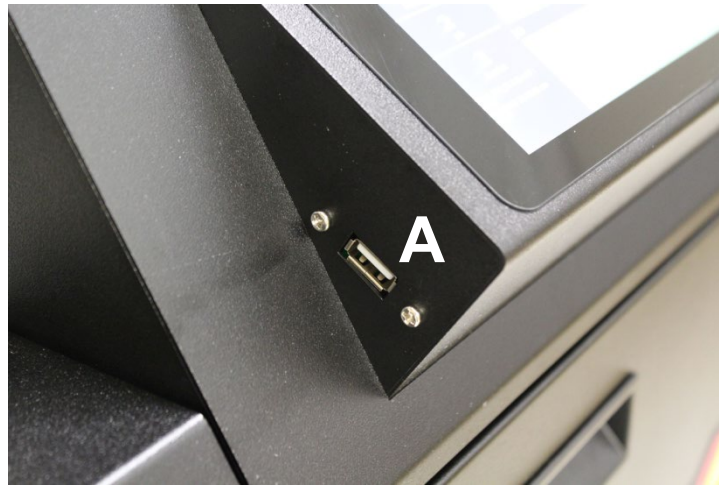

When a FAT 32 formatted USB Flash Drive is plugged into the USB port [A] located on left side of the Touchscreen Control Panel, the **USB Backup** screen opens:

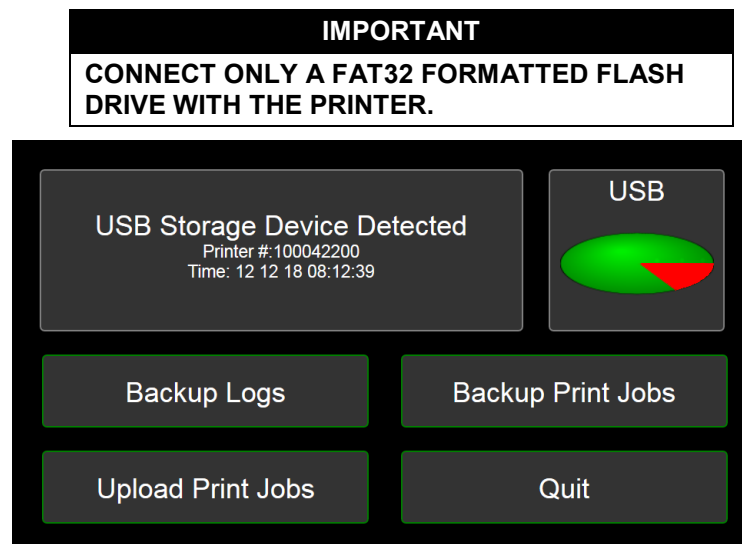

USB Storage Device Detected. Lists the Printer you are connected to, date and time.

USB: Graph shows the amount of usable memory left on the USB Flash Drive plugged into the Printer.

Backup Logs: Backs up all of the **Debug Log** files currently on the Printer.

Backup Print Jobs: Backs up all of the **Print Jobs** saved in the Printer's **Print Job Library**.

Upload Print Jobs: Allows you to copy/transfer print jobs from other Printers and sources to this Printer.

Quit: Press to exit the backup screen and safely eject the USB Flash Drive.

Backup Logs

Touch the **Backup Logs** button to copy all current log files from the printer. The screens below will appear

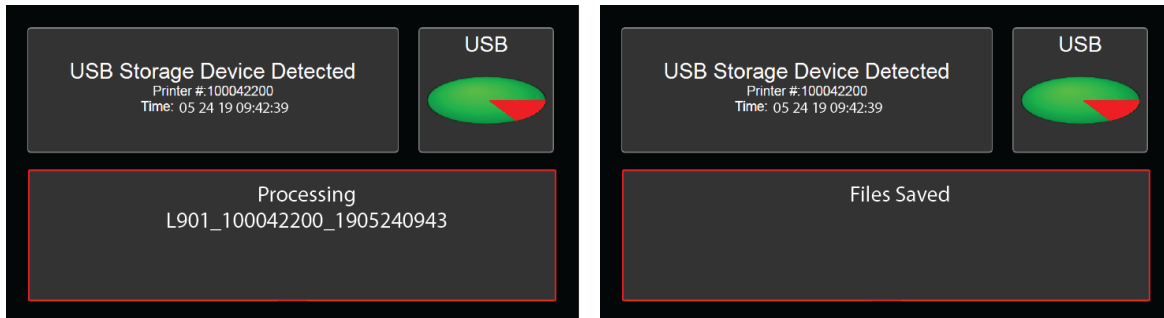

All available system and operations logs will be saved to two files using a compressed file format (.tgz). The file names will include the printer model (CP950), the printer Serial Number (100042200, in this example), a date stamp (YYMMDD), and a timestamp (HHMMSS) based on when the logs were backed up.

The Backup Logs button will show that the files were saved and what the file names are.

Backup Print Jobs

Touch the **Backup Print Jobs** button to make backup copies of all stored jobs on the printer. The Processing and Files Saved messages will appear and the Backup button will show the location of the files on the USB drive.

The files will be saved to the `prns\{name displayed}` folder on the root of the USB drive as .prn files with the same name as the saved print job. It will also save the named thumbnail images in `prns\{name displayed}\thumbs`.

While these files can be moved from one CP950 to another, they are formatted for printing only from the CP950 saved jobs library.

Upload Print Jobs

You can restore or upload backed up print jobs back to the CP950 using the **Upload Print Jobs** button.

If you have more than one backup set on the USB drive, you can pick which backup set to upload.

The Processing and Files Saved messages will appear and the Upload button will indicate that the upload is complete.

If you have print jobs on the printer with the same names as those in the backup, those print jobs on the printer will be overwritten with the jobs from the USB drive.

Print jobs on the printer that don't match the names of the backed up jobs will not be affected. They will still be on the printer after the upload.

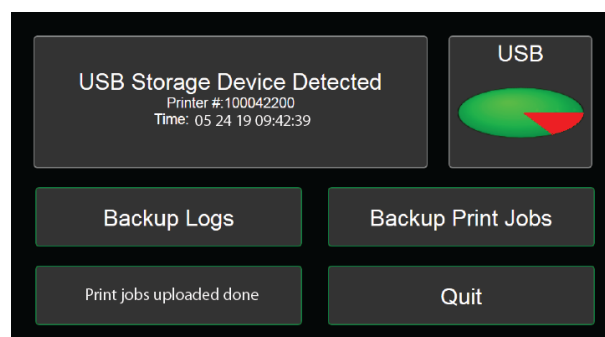
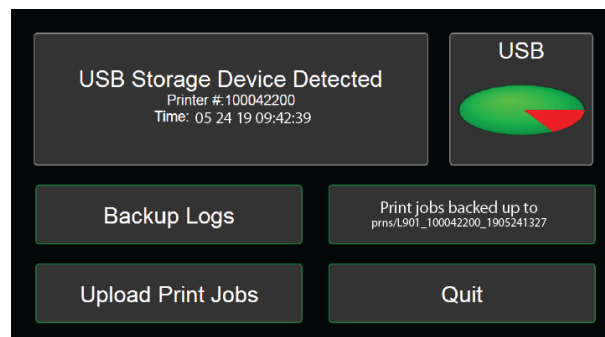
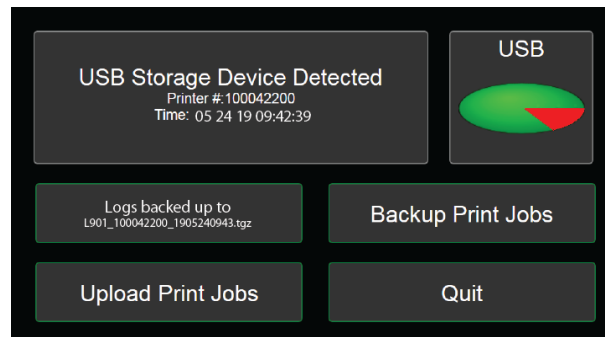

SECTION 3 OPERATING PRINTER

Using Printer Toolbox

Once Printer Driver is installed, you can access the **Printer Toolbox** remotely from a computer. You can check Printer status, monitor ink usage, perform diagnostic checks, print reports and run maintenance tasks on Printer from your computer. The **Toolbox** also has a more extensive list of functions not available on the **Touchscreen** and a password protected access to a range of options for qualified service personnel. For **Touchscreen** functions, see “Using Printer Touchscreen” preceding this section. **The Toolbox works with both conventional and touchscreen computer monitors.**

To open the Printer Toolbox (from a computer):

Enter for “L901 Driver Toolbox” in the Program Search Window.

For Windows 7, click **Start Button**, select **Afinia Label** folder, select **Afinia L901 Driver**, the select **Toolbox**

NOTE: Conventional Screens: Use your cursor. **Touchscreens:** Tap buttons or selections or use your cursor.

[A] System Status Indicator and Drop-Down Menu Options (at top of screen)

[B] Check Printer Status (across middle of screen)

[C] Three often-used control buttons (at bottom of screen)

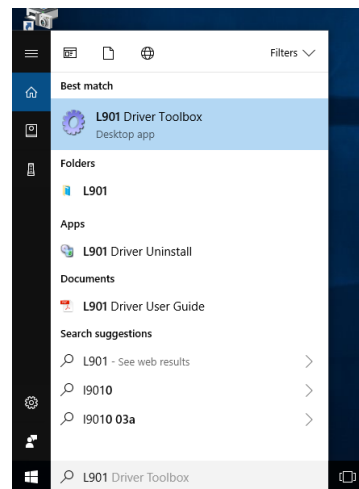
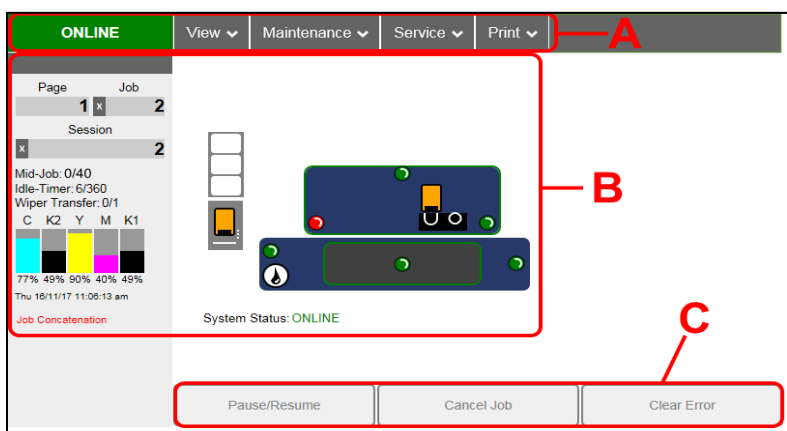

Drop-Down Menu Options

There are four **Drop-Down Menus**:

- **View**
- **Maintenance**
- **Service**
- **Print**

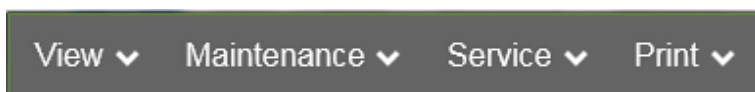

The drop-down menus are available on every Toolbox screen allowing you to toggle between menus and select different Printer features and functions.

View Drop-Down

The **View** drop-down gives you four choices:

- **System Status**
- **User Interface**
- **Ink Usage**
- **Service Menus**

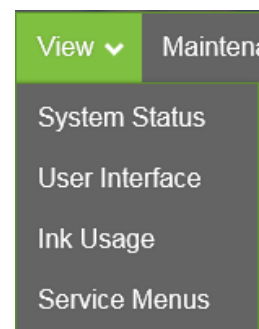

System Status

This screen opens when you access the Toolbox. It provides information about the Printer.

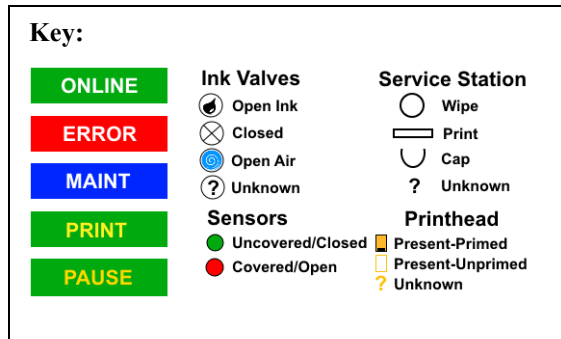
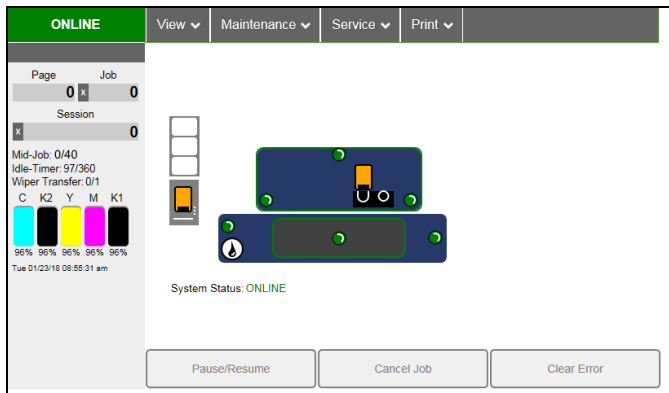

1. **Status Indicator** shows Printer activity as **ONLINE**, **ERROR**, **MAINTENANCE**, **PRINTING** or **PAUSED**. The gray box (*below Status Indicator*) shows the name of the job being processed.
2. **Page** shows the page count for a given job.
3. **Job** shows number of jobs printed (*resettable*)
4. **Session** shows the total number of pages printed (*resettable*) over the length of a Session (*shift, day, week, etc*).
5. **Mid-Job** counts down from a specified preset length of printed media until the next automatic Printhead maintenance is performed by the Service Station.
NOTE: Select the length by opening the Printer Toolbox **User Interface** screen, **Mid-Job Servicing**. In this example, service is performed every 40 meters (131-ft.).
6. **Idle Timer** shows in minutes how often maintenance will run when Printer is not running. Minutes are set in the **User Interface** screen, **Idle Timeout (min)**.
7. **Wiper Transfer** shows how often a Wiper Transfer (*cleaning excess ink from the Service Station roller*) will be performed in relation to when Wipe Printhead or Printhead Cleaning is performed.
8. **Ink Levels** displays percentage of ink remaining in each of the Ink Tanks.
9. **Date and Time** shows current date and time. These can be configured and set by opening the **Service** dropdown screen, **System Settings, Date and Time**.
10. **Printer Messages** may appear under **Date and Time**.
11. **Media Icon:** Displays the type of media the Printer is currently configured for – **Continuous**, **Diecut** or **Black Mark**. Set the type of media by tapping the icon on the touchpanel and selecting the appropriate media type or using the **Media Scan** function after selecting **Service Menus** from the **View** dropdown.
12. **Printhead Height Icon:** Shows current Printhead printing height setting. (*3 dots = Low, Normal, High settings*; Set in **User Interface** screen, **Print Height**)
13. **Printer Icon:** Shows status of Media Sensors located in the media feed path of the Printer. Also shows status of Ink Valves, Service Station, Printhead and auxiliary devices (*such as Unwinders and Winders*). These can alert the operator to the type and location of a problem. (*See icon key above.*) Rolling over any of the status icons with your cursor pops up a description of that icon.
14. **System Status** displays current status of the Printer and/or an error message.

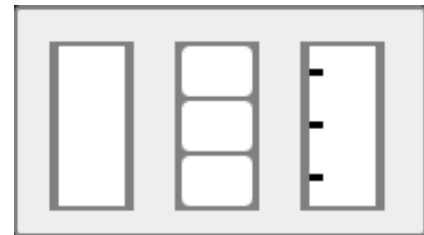

SECTION 3 OPERATING PRINTER

CONTROL BUTTONS (*located along bottom of screen*): Provide quick access to often-used functions.

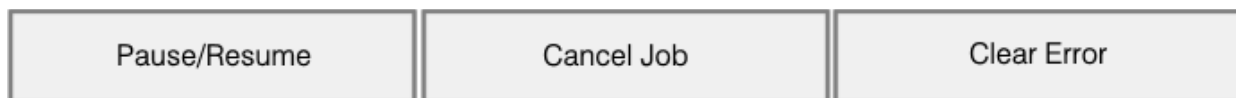

Pause/Resume: Tap to temporarily stop printing. Tap again to resume printing.

Cancel Job: Cancels a job from the printing queue.

NOTE: Cancelled jobs must be reloaded before printing can resume.

Clear Error. Click the button to clear error messages after you have resolved a Printer problem (*ie, after clearing a paper jam*).

User Interface

SET-UP SETTINGS:

Adjust the Printer for automated service and cleaning intervals, for different types of media and to set the feeder speed for a job.

Mid-Job Servicing – Sets how frequently an automatic maintenance cycle is performed by selecting the length of printed media (*in meters*) that is run between cycles.

Minimum: 60m/197-ft.

Normal (Default): 40m/131-ft.

Maximum: 15m /49.25-ft.

NOTE: Mid-Job Servicing can only be set when the Printer is stopped or paused.

KWS Setting – (*Keep Wet Spitting*) Keeps Printhead hydrated while running a job.

Select from 4 settings: None, Light, Medium (default), Heavy, to determine how much ink will “spit” from Printhead Nozzles. Set in conjunction with “**Mid-Job Servicing**” which determines frequency of Printer stopping for self-servicing during a job.

Interpage Frequency – On roll-to-cut jobs, set when the Printer spits between labels (*to keep the Printhead nozzles hydrated and unclogged*). **For example:** 3 = after every 3rd label; 5 = after every 5th label, etc.

Idle Timeout (min) – Set in minutes how often idle maintenance will run when the Printer is not running.

Media Feed – Sets the Printer Sensors to read the type of media and/or the gaps between media when you select **Continuous, Diecut or Blackmark**.

Internal Print Job Cut – Checking this box allows you to print and cut one of the reports or test pages listed in the **Print** dropdown menu.

Print Height – Set the height of the Printhead to adjust for printing on different media thicknesses. Select one of three settings: **High, Normal, or Low**. An indicator appears on the **Status** Toolbox screen and Touchscreen.

Click “**Submit**” to apply settings.

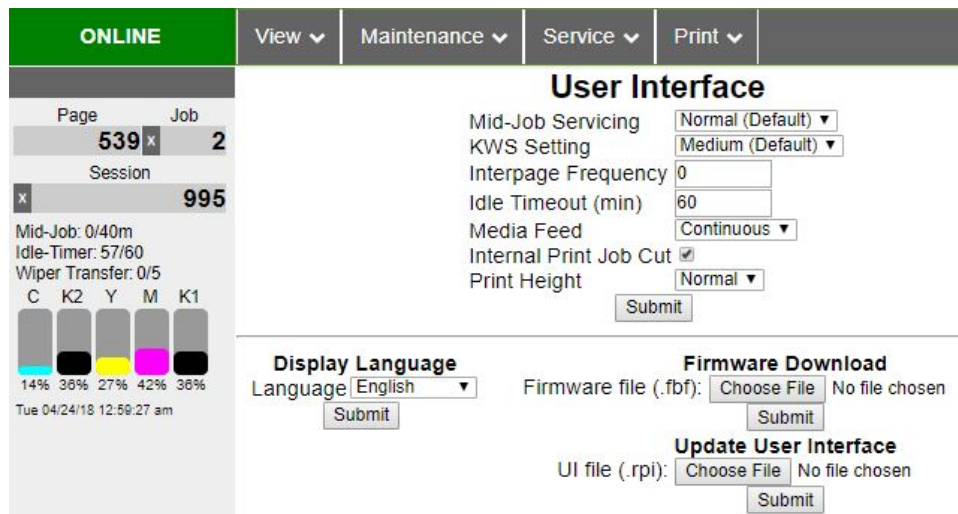
The screenshot shows the printer's control panel interface. At the top, there's a green 'ONLINE' status bar and a navigation menu with 'View', 'Maintenance', 'Service', and 'Print' options. Below this, a 'User Interface' settings screen is displayed. On the left, a 'Status' panel shows 'Page 539 x Job 2', 'Session 995', and ink levels for C (14%), K2 (36%), Y (27%), M (42%), and K1 (36%). The main settings area includes: 'Mid-Job Servicing' (Normal (Default)), 'KWS Setting' (Medium (Default)), 'Interpage Frequency' (0), 'Idle Timeout (min)' (60), 'Media Feed' (Continuous), 'Internal Print Job Cut' (checked), and 'Print Height' (Normal). There are 'Submit' buttons for these settings. At the bottom, there are sections for 'Display Language' (English) and 'Firmware Download' (No file chosen), with another 'Submit' button.

DISPLAY LANGUAGE: Selects language EWS (*Toolbox*) and Touchscreen will display. Click “**Submit**” after selecting language.

The screenshot shows the printer's control panel interface. At the top, there are navigation tabs: ONLINE (highlighted in green), View, Maintenance, Service, and Print. Below these are status indicators for Page (0), Job (0), and Session (0). A section for ink levels shows C, K2, Y, M, and K1 with 96% levels. The main area is titled 'User Interface' and contains several settings: Mid-Job Servicing (Normal), KWS Setting (3), Interpage Frequency (0), Idle Timeout (min) (360), Media Feed (Diecut), Internal Print Job Cut (checked), and Print Height (Normal). Below these settings are three sections: 'Display Language' (Language: English, Submit), 'Firmware Download' (Firmware file (.fbf): Browse..., Submit), and 'Update User Interface' (UI file (.rpi): Browse..., Submit). A red box highlights the 'Display Language' section.

FIRMWARE DOWNLOAD: Get the latest version of firmware for your Printer. **Two types of firmware files are normally provided: “.bin” files and “.fbf” files. “.fbf” files are loaded using the Printer Toolbox.**

Browse for the firmware file and click **Submit**.

Firmware updates can take 10 minutes or more to complete. DO NOT power down printer during this process!

This screenshot is identical to the one above, showing the printer's control panel interface. A red box highlights the 'Firmware Download' section, which includes a 'Browse...' button for the 'Firmware file (.fbf):' field and a 'Submit' button.

WARNING!

Updating the firmware should only be performed by qualified service personnel. If this process is not performed properly, the printer can be rendered non-operational.

UPDATE USER INTERFACE: Download and install the latest User Interface UI (.rpi) file for the Printer Touchscreen.

NOTE: Updating this file does not require shutting down or rebooting the Printer.

This screenshot is identical to the ones above, showing the printer's control panel interface. A red box highlights the 'Update User Interface' section, which includes a 'Browse...' button for the 'UI file (.rpi):' field and a 'Submit' button.

SECTION 3 OPERATING PRINTER

Ink Usage

Ink Usage displays the amount of each ink used per print job, as well as job information, estimated cost per label, and estimated cost for the entire job.

PRINTING												
View Maintenance Service Print												
Ink Usage												
Printed Ink (µL)					Time	Job	Pages Printed	Quality	Media Type	Media Size (mm)	Estimated Page Cost	Estimated Job Cost
Cyan	Magenta	Yellow	Black	Black								
5	6	10	4	4	03/11/17 09:17:08	4 Test files1.cdr_0.prm	3	Normal	Plain Paper	107 x 38	0.000	0.000
5	6	10	4	4	03/11/17 09:16:43	3 Test files1.cdr	3	Normal	Plain Paper	107 x 38	0.000	0.000
5	6	10	4	4	03/11/17 09:14:53	2 Test files1.cdr	3	Normal	Plain Paper	107 x 38	0.000	0.000

Refresh Upload Table

Ink Estimation Mode
Mode Off Submit

Job Cost Settings
Tank Cost 0
Printhead Cost 0
Media Size mm Submit

NOTE: Ink Usage only works when a new Ink Tank is installed and left in the Printer.

INK ESTIMATION MODE – Lets you predetermine how much ink a given job may use prior to printing a job. This is useful for determining per piece costs. Job is sent to Printer and loads, but does not print. Once job is loaded, click **“Refresh”** to show amount of ink (*by color*) that job will use.

Upload Table – Creates and opens a linkable tabular data file using programs such as Microsoft Excel. (*Microsoft Excel is the default.*)

Mode selection:

Off – Feature is disabled.

Continuous – Ink Estimation Mode continues running (*Printer will not print*), until feature is turned **“OFF”**.

Single Pass – Ink Estimation Mode runs once, then turns off. Printer will then be ready to print.

Click **“Submit”** to activate **Mode** setting selected.

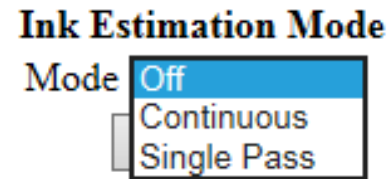

NOTE: The estimating process takes as long as the job would take to print (i.e., if a job would take one hour to print, the estimate will take one hour to display. Track progress on the Counter located in the System Status window.)

Reset Page Counter – Tap or click this button to reset the Printer page count to 0 (**Page** on the Printer Toolbox and Touchscreen).

JOB COST SETTINGS – Enter your **Ink Tank Cost**, **Printhead Cost** and **Media Size** preference (*inches or mm*).

Set a minimum of at least 100 pcs. to ensure a large enough sample size. Click **“Submit”**. In **Ink Estimation Mode**, this feature estimates per page cost and job cost without printing job. With **Ink Estimation Mode** disabled, Printer still tracks estimated per page cost and estimated job cost as job is being printed. Once costs are entered, they will remain until changed again, even if Printer is turned OFF.

Job Cost Settings	
Tank Cost	<input type="text"/> 100
Printhead Cost	<input type="text"/> 100
Media Size	<input type="text"/> mm <input type="text"/>
Submit	

NOTE: This is only an estimate and does not include other factors such as Printer maintenance routines, (printhead wiping and cleaning, power up/down, etc.) that may affect overall result.

Service Menus

Clicking **Service Menus** opens the **Service Menus** (*Diagnostics*) screen and service menu buttons.

Diagnostics button. Click to check the status of the Printer (see *Diagnostics* below).

System Settings button. Click to view, enter or change settings to connect Printer to your network (see *Network Settings* on page 43). Also configure and set the Printer's **Date and Time**. And set the level of detail desired for **Debug Logs**.

Debug Logs. Click to display a list of available Debug Logs that can be opened or uploaded. Then select the Log or Logs to be uploaded.

Media Scan. Use **Media Scan** to fine tune sensor sensitivity and/or adjust scan length if media is not printing correctly, or to determine if a type of media is going to have problems printing. This is generally due to the sensors having trouble differentiating between the label surface and backing/gap (see *Media Scan* on page 47).

Scan Sensors button. Provides status and a log of sensor activity on sensors located throughout the Printer (see *Scan Sensors* on page 48).

Service Menus, Password: Entering the **Service Menu password** provides access to more advanced Printer control and maintenance menus. For authorized service personnel only.

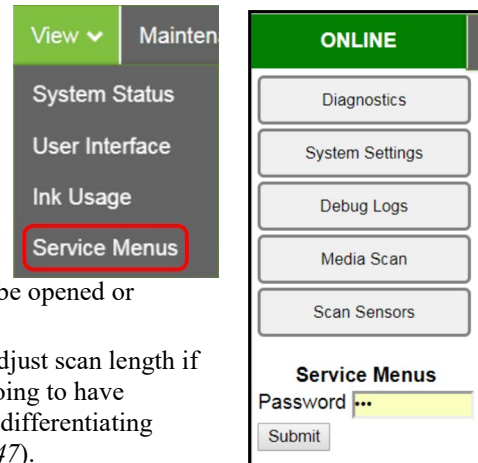

Diagnostics

This is the screen that opens when you select “**Service Menus**”. From this screen you can see current status of the Printer.

Other features:

Upload Debug Log – Upload and save a log of the Printer status to send to a technician to help diagnose a problem. Clicking this button creates a snapshot log showing everything going on with the Printer since powering up (see *Sample Log* at right).

NOTE: If a problem arises, try to recreate the problem, then press the **Upload Debug Log** button without performing any other actions. This may make it easier for the technician to determine the problem. If this is not possible, include any actions you may have taken after the problem began.

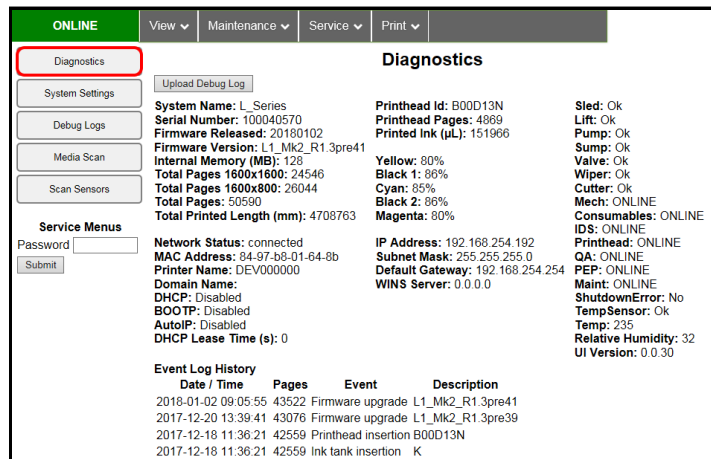

Other information provided in the Diagnostics window:

Event Log History – Displays significant events occurring on the Printer (such as *firmware updates, errors, power off, etc.*). This log is useful for troubleshooting Printer problems.

NVM Settings – Displays Printer's current NVM (*Non-Volatile Memory*) settings.

Once settings are saved, they remain even when Printer is turned off, until they are manually changed.

VARS Settings – Displays Printer's current VARs (*Variable*) settings.

Settings that are set for a particular job that automatically revert to the default settings when the Printer is turned off or rebooted.

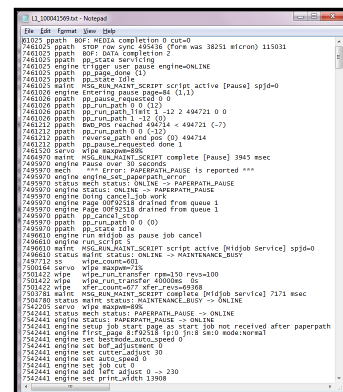

SECTION 3 OPERATING PRINTER

System Settings

Set up a network connection for the Printer. You can also configure and set the Printer **Date and Time**, set the **Debug Log Level** and **Screensaver Timeout** (*sleep delay*).

Network Settings – Permits you to view, enter or change settings to connect the Printer to your network.

Network Connection Set Up:

1. Printer is still connected to computer via USB cable.

To connect the Printer to a network: From the **Toolbox**, select “**View**” drop-down menu, click “**Service Menus**”, then click “**System Settings**”.

2. “**System Settings**” screen opens. Use **Network Settings** to enter correct settings for your network.

NOTE: If manually changing the **ip_address**, make sure the “**dhcp**” and “**autoip**” boxes are **unchecked**. (*Default is checked.*) Enter changes in the appropriate boxes. Click “**Submit**”.

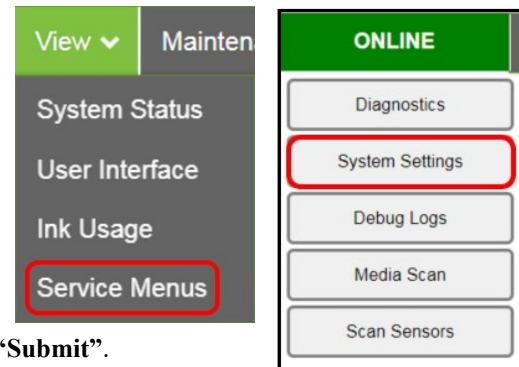

3. Connect Ethernet cable to Network Port on Rear Panel of Printer.



Date and Time – Enter or change the way the date and time will appear in the Printer Status section of the Toolbox screens. **To enter or change Date and Time:**

1. From the Toolbox, select “View” drop-down menu, click “Service Menus”, then click “System Settings”.
2. “System Settings” page opens. Use **Date and Time options** to enter, edit and format the Date and Time for the Printer.
3. Click “Submit”.

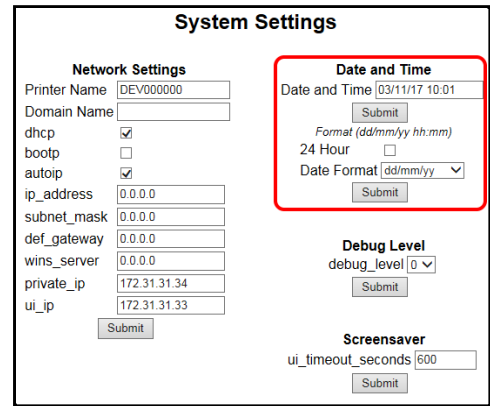
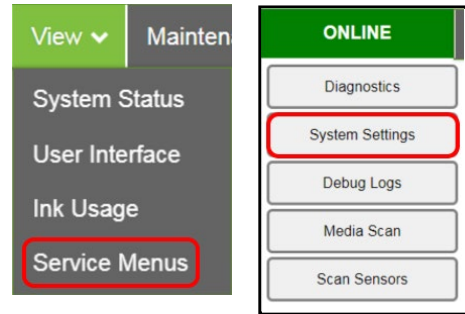

Debug Level – Set the detail level of the Debug Logs. **To change the Debug Level:**

1. From the Toolbox, select “View” drop-down menu, click “Service Menus”, and then click “System Settings”.
2. “System Settings” page opens. Go to **Debug Level options** and select 0, 1, or 2 to set the desired detail level for the Printer. (0 = least detailed, 2 = most detailed).

NOTE: Because of the amount of data collected and stored, it is recommended that you not set the **Debug Level** over 1 unless asked by a service technician.

3. Click “Submit”.

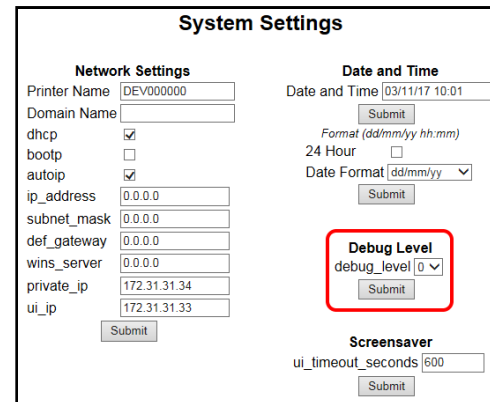
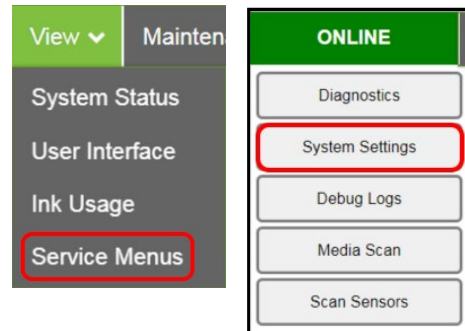

SECTION 3 OPERATING PRINTER

Screensaver – Set the amount of time the Touchscreen will remain idle before automatically going to Sleep Mode.

1. From the **Toolbox**, select “**View**” drop-down menu, click “**Service Menus**”, and then click “**System Settings**”.
2. “**System Settings**” page opens. Go to **Screensaver**. Enter the number of seconds the Touchscreen will remain idle before going to Sleep Mode.
3. Click “**Submit**”.

The screenshot shows a printer's main menu with two columns. The left column has a 'View' dropdown menu and four menu items: 'System Status', 'User Interface', 'Ink Usage', and 'Service Menus'. The 'Service Menus' item is highlighted with a red box. The right column has a green 'ONLINE' status bar and four menu items: 'Diagnostics', 'System Settings', 'Debug Logs', and 'Scan Sensors'. The 'System Settings' item is highlighted with a red box.

The screenshot shows the 'System Settings' page. It is divided into three sections: 'Network Settings', 'Date and Time', and 'Debug Level'. The 'Screensaver' section is highlighted with a red box. The 'Screensaver' section contains a text input field labeled 'ui_timeout_seconds' with the value '600' and a 'Submit' button below it.

Network Settings		Date and Time	
Printer Name	DEV000000	Date and Time	03/11/17 10:01
Domain Name			Submit
dhcp	<input checked="" type="checkbox"/>	Format (dd/mm/yy hh:mm)	
bootp	<input type="checkbox"/>	24 Hour	<input type="checkbox"/>
autoip	<input checked="" type="checkbox"/>	Date Format	dd/mm/yy
ip_address	0.0.0.0		Submit
subnet_mask	0.0.0.0		
def_gateway	0.0.0.0		
wins_server	0.0.0.0		
private_ip	172.31.31.34		
ui_ip	172.31.31.33		
	Submit		
		Debug Level	
		debug_level	0
			Submit
		Screensaver	
		ui_timeout_seconds	600
			Submit

Debug Logs

Access, print or send activity logs for the Printer and for jobs run on the Printer. These files are valuable for diagnosing and servicing problems.

All – Shows all log files available.

Debug – Shows only **Debug** log files.

Jobs – Shows only **Jobs** printed log files.

ONLINE View Maintenance Service Print

Diagnostics **All** Debug Jobs

System Settings

Debug Logs

Media Scan

Scan Sensors

Service Menu

Password

Submit

Available Files

Files	Size
job_2017-11-07.log	66
job_2017-11-06.log	1305
job_2017-11-05.log	3865
job_2017-11-03.log	486
job_2017-11-02.log	724
job_2017-10-30.log	489
job_2017-10-27.log	63
job_2017-10-26.log	1768
job_2017-10-25.log	172
job_2017-10-24.log	1479
job_2017-10-23.log	812
job_2017-10-20.log	390
job_2017-10-19.log	548
job_2017-10-18.log	785
2017-11-07.log	49272
2017-11-06.log	39781
2017-11-06-1433333.log	100069
2017-11-06-102448.log	100949
2017-11-05.log	98524

1 2 3 4 5

ONLINE View Maintenance Service Print

Diagnostics All **Debug** Jobs

System Settings

Debug Logs

Media Scan

Scan Sensors

Service Menu

Password

Submit

Available Files

Files	Size
2017-11-07.log	49272
2017-11-06.log	39781
2017-11-06-1433333.log	100069
2017-11-06-102448.log	100949
2017-11-05.log	98524
2017-11-05-1145.log	100004
2017-11-05-9917.log	100072
2017-11-05-9902.log	100026
2017-11-03.log	69567
2017-11-03-1400.log	100084
2017-11-03-1344.log	100041
2017-11-03-1321.log	100130
2017-11-03-1304.log	100122
2017-11-03-1249.log	100100
2017-11-03-1234.log	100081
2017-11-03-1219.log	100014
2017-11-03-1200.log	100034
2017-11-03-1145.log	100050
2017-11-03-1130.log	100037

1 2 3 4 5

ONLINE View Maintenance Service Print

Diagnostics All Debug **Jobs**

System Settings

Debug Logs

Media Scan

Scan Sensors

Service Menu

Password

Submit

Available Files

Files	Size
job_2017-11-07.log	66
job_2017-11-06.log	1305
job_2017-11-05.log	3865
job_2017-11-03.log	486
job_2017-11-02.log	724
job_2017-10-30.log	489
job_2017-10-27.log	63
job_2017-10-26.log	1768
job_2017-10-25.log	172
job_2017-10-24.log	1479
job_2017-10-23.log	812
job_2017-10-20.log	390
job_2017-10-19.log	548
job_2017-10-18.log	785

1

SECTION 3 OPERATING PRINTER

Media Scan

Use **Media Scan** to fine tune sensor sensitivity and/or adjust scan length if media is not printing correctly, or to determine if a type of media is going to have problems printing. This is generally due to the sensors having trouble differentiating between the label surface and backing/gap.

Media Scan cannot be used with Continuous media.

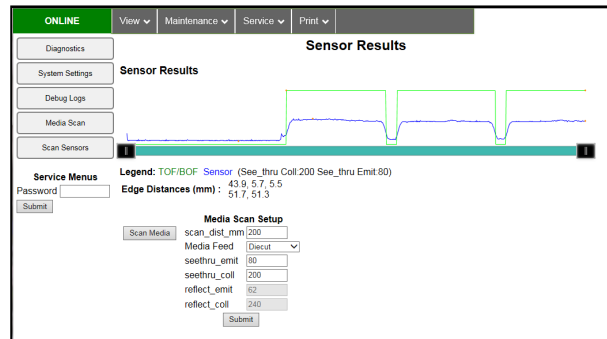

NOTE: If using notched Tags, open the Top Cover and slide the white magnetic strip [A] back to uncover the See-Thru Sensor [B]. Cover the Sensor for all other media.

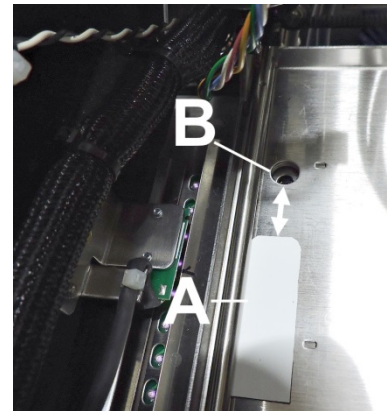

Media Scan Procedure:

1. Load media in Printer as if printing a job.
2. **From the Toolbox**, select the “View” drop-down menu, click “Service Menus”. Click “Media Scan”.
3. Under “Media Scan Setup”, set “scan_dist_mm”:
The media length for the scan in millimeters. Set length at least 4-5 labels long.
4. Set “Media Feed”: Select what type of media is being fed; **Continuous**, **Diecut** or **Blackmark**.
5. For **Diecut** or **Blackmark** media, (*some or all of the Sensors may be inactive for different types of media*), set Sensor sensitivities:
 - a. **For Diecut:**
 - i. Set “seethru_emit”: 0 to 100.
 - ii. Set “seethru_coll”: 0 to 100.
 - b. **For Blackmark:**
 - i. Set “reflect_emit”: 0 to 100.
 - ii. Set “reflect_coll”: 0 to 100.

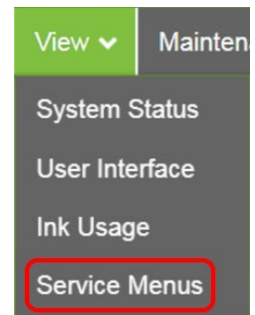

The screenshot shows the printer's web interface with the "Media Scan" button highlighted in red. The "Service Menus" section is visible, showing a password field and a "Submit" button. The "Media Scan Setup" section is also visible, showing a "Scan Media" button and several input fields: scan_dist_mm (200), Media Feed (Continuous), seethru_emit (85), seethru_coll (225), reflect_emit (50), and reflect_coll (240), each with a "Submit" button.

- Click “Submit” to enter your selections, then click the “Scan Media” button. Blank media moves across sensors to create the graph shown on the screen.

NOTE: Rolling the cursor over the blue graph line provides readouts of the points on the graph.

Legend: Explains what the graph is showing. **Media** (TOF/BOF-Green line). **Sensor** (Sensor-Blue line).

Edge Distances: **Top line** shows the average gap distance reading in millimeters. **Bottom line** shows the length of the label reading in millimeters.

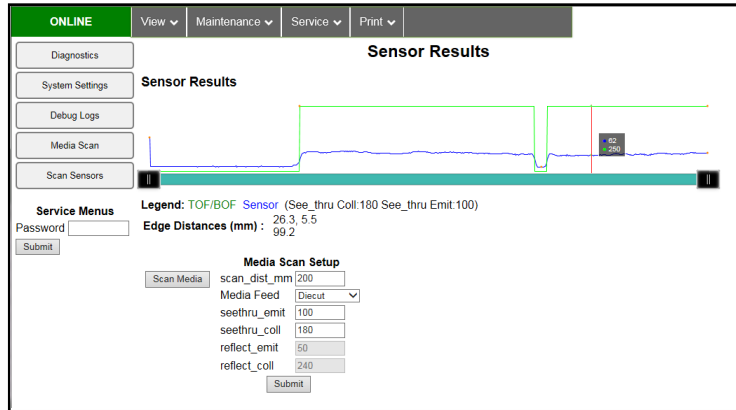

- If the graph and/or results require adjusting, you can increase or decrease the Sensor sensitivity by changing the Sensor sensitivity values. You can also increase or decrease the length of media to be scanned by changing the `scan_dist_mm` value. Press the **Scan Media** button again to obtain a new result.

NOTE: Make sure that the label type and the Toolbox **Media Feed** type selection match. Only the sensors for that type of media will be active. If the label type is different, an **Error** will show in the System Status box.

NOTE: **Media Scan** is also available on the Printer Touchscreen (See *Media Scan in Using the Touchscreen on page 33*).

Scan Sensors

Provides status updates and an activity log on the Sensors located throughout the Printer (see chart below.)

Click “Stop” button to stop scanning or click out of “Scan Sensors”.

ONLINE		View	Maintenance	Service	Print	Sensor History																				
Diagnosics	Stop	Feeder Sensor	See-Thru Sensor	Reflect Sensor	Exit Sensor	Valve Position	Sled Lift	Lift Station	Lift Home	Sled Encoder	Sled Encoder	Printhead Latch	Print Encoder	Pump Running	Pump Encoder	Wiper Running	Wiper Encoder	Sump Encoder	Valve Sensor 1	Valve Sensor 2	Temperature	Y Out	M Out	C Out	K1 Out	K2 Out
0	1	1	0	openink	cap	cap	cap	Off	-4742	Off	-29220	Closed	0	No	1	No	-2571855	578082	Off	On	240	No	No	No	No	No
0	1	1	0	openink	cap	cap	cap	Off	-4742	Off	-29220	Closed	0	No	1	No	-2571855	578082	Off	On	240	No	No	No	No	No
0	1	1	0	openink	cap	cap	cap	Off	-4742	Off	-29220	Closed	0	No	1	No	-2571855	578082	Off	On	240	No	No	No	No	No
0	1	1	0	openink	cap	cap	cap	Off	-4742	Off	-29220	Closed	0	No	1	No	-2571855	578082	Off	On	240	No	No	No	No	No
0	1	1	0	openink	cap	cap	cap	Off	-4742	Off	-29220	Closed	0	No	1	No	-2571855	578082	Off	On	240	No	No	No	No	No
0	1	1	0	openink	cap	cap	cap	Off	-4742	Off	-29220	Closed	0	No	1	No	-2571855	578082	Off	On	240	No	No	No	No	No
0	1	1	0	openink	cap	cap	cap	Off	-4742	Off	-29220	Closed	0	No	1	No	-2571855	578082	Off	On	240	No	No	No	No	No
0	1	1	0	openink	cap	cap	cap	Off	-4742	Off	-29220	Closed	0	No	1	No	-2571855	578082	Off	On	240	No	No	No	No	No
0	1	1	0	openink	cap	cap	cap	Off	-4742	Off	-29220	Closed	0	No	1	No	-2571855	578082	Off	On	240	No	No	No	No	No

SENSOR	DESCRIPTION
See-Thru Sensor (Paper Path Entry)	Interrupted (<i>media present</i>) = 0-60 Uninterrupted (<i>no media</i>) = 255
Reflect Sensor	Uninterrupted = 0 Interrupted (<i>blocked</i>) = 1
Exit Sensor (Paper Path Exit)	Uninterrupted = 0 Interrupted (<i>blocked</i>) = 1
Valve Position	Displays operating positions of Dual Pinch Valve: “OpenAir,” “OpenInk,” and “Closed”. “Unknown” will display as Valve transitions between positions. NOTE: If “Unknown” displays for more than a few seconds, it may indicate a problem.

SECTION 3 OPERATING PRINTER

Maintenance Drop-Down

Perform maintenance tasks on the Printer.

Circulate Ink – Purges air from lines and primes system after replacing Ink Tanks or Printhead.

Normal Clean Printhead – Runs cleaning and wiping routine twice for better flushing and cleaning.

Wipe Printhead – Wipes and cleans excess ink from Printhead.

Inspect Sled – Moves Service Station out for inspection, cleaning or service.

End Inspection – Moves Service Station back into position under the Printhead. Closing the top door will also end the inspection.

Wiper Transfer – Squeegees excess ink off of Service Station Wiper Roller.

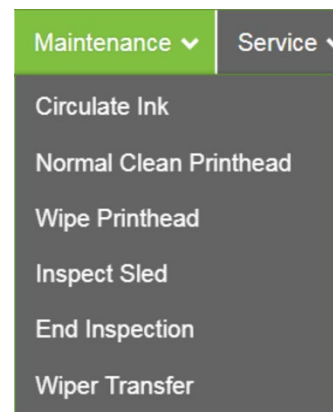

Service Drop-Down

Control functions that require the Printer to be out of service for extended periods of time while they are being performed.

System Deprime – Pumps ink back into Ink Tanks prior to replacing the Printhead or transporting the Printer.

Shutdown – Turns Printer OFF. For best system performance, it is recommended to keep Print Engine powered-up (*ON/OFF light illuminated*) at all times. If turning the Printer off, first power-down the Print Engine using “**Shutdown**” button in **Toolbox** or ON/OFF button on Control Panel. Wait until the Touchscreen **AND** green power LED turn off before turning off the Main Power Switch.

Restart – Restarts the Printer without having to perform the normal shutdown routine.

Restart UI – Restarts the Printer Touchscreen without having to perform the Printer startup routine (*purging ink tanks, priming, etc.*)

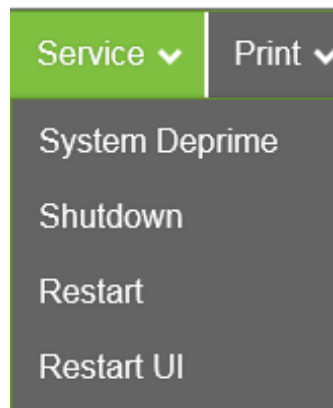

Print Drop-Down

Print various reports and Printer tests. Each printout displays information about the Printer.

NOTE: 8.5” wide continuous stock required for these four prints.

Print Setup Page – Prints a printing pattern used for positioning the image on the page.

Print Configuration – Prints current Printer configuration including Firmware Version, Network Connection, Printer Serial Number and more.

Print Printhead Test – Prints color bands, text and patterns to check condition of Printhead ink nozzles. **NOTE: Uses less ink than Print Color Bars.**

Print Color Bars – Prints a series of 7 color bars (*per Printhead*) to indicate how well Printhead is mixing colors and printing.

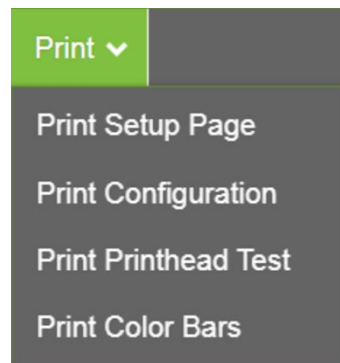

SECTION 4 – Maintenance

IMPORTANT NOTE: For the best print results, it is recommended that the printer be left powered on. This services the print head on a regular basis, allowing for the best print quality.

General, periodic maintenance is needed to keep Printer in good working order. This section covers how to care for Ink Tanks, Printhead, Service Station, and clear paper jams.

In addition, a maintenance reminder will appear at 500,000 printed inches:

Maintenance/Cleaning Recommended
Refer to user manual for detailed steps.

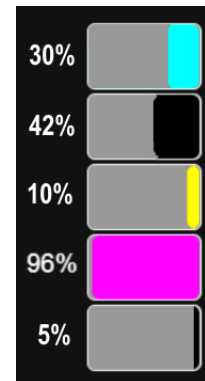

Replace Ink Tanks

Replace Ink Tanks when ink runs out.

1. **Look at the Control Panel Touchscreen.** Ink Tank Status information appears left side of the Touchscreen.

Note that more than one of Ink Tank indicators may be low or empty.

2. **Open Ink Tank Door** (*hinged at bottom*). (*Disconnects Printer communication with Ink Tanks and allows safe installation and replacement.*) Open Ink Tank Latches [A] and pull Ink Tank(s) [B] out of Printer.
3. Remove new Ink Tank(s) from packaging.
4. Slide new Ink Tanks (*labels up*) into appropriate color slots [B]. Close Ink Tank Latches.

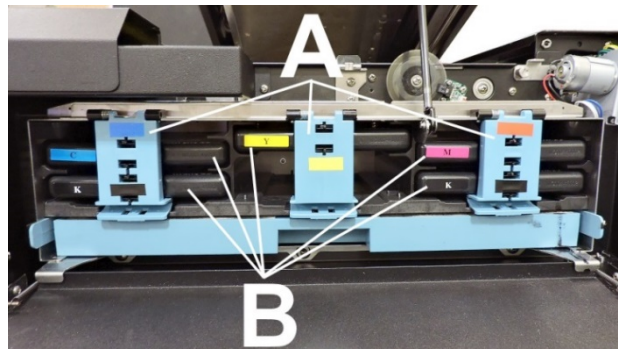

INSTALLATION TIP: Make sure Ink Tanks seat properly.

Insert Ink Tank into appropriate Ink Station, then pull Ink Tank back about an inch and push forward firmly to insure that Ink Nozzles penetrate seals on Ink Tanks.

5. **Close the Ink Tank Door.** Ink colors fill in as Ink Tanks are installed. If ink colors do not fill in after a few seconds, open the Ink Tank Door and reinstall Ink Tank(s).

NOTE: If Ink Tank is installed, but Ink Tank indicator still does not refresh, see “Clean Ink Tank Contacts” below.

6. When Printer stops processing and no errors appear on the System Status screen, Printer is ready for use.

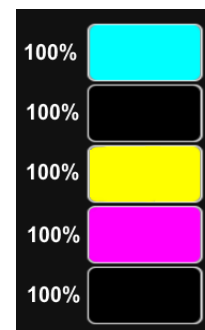

WARNING!

Ink in Ink Tanks may be harmful if swallowed. Keep new and used Ink Tanks out of reach of children. Discard empty Ink Tanks immediately.

SECTION 4 MAINTENANCE

Clean Ink Tank Contacts

When reinstalling or replacing Ink Tanks, the Ink Level indicators on the Touchscreen may not refresh. This may be due to a dirty Ink Tank Level Prism and/or QA Chip contacts on that Ink Tank(s).

Clean contacts as follows:

1. **Remove Ink Tank(s).** Open Ink Tank Door. Release Ink Tank Latch(es) [A]. Remove Ink Tank(s) [B] that did not refresh.

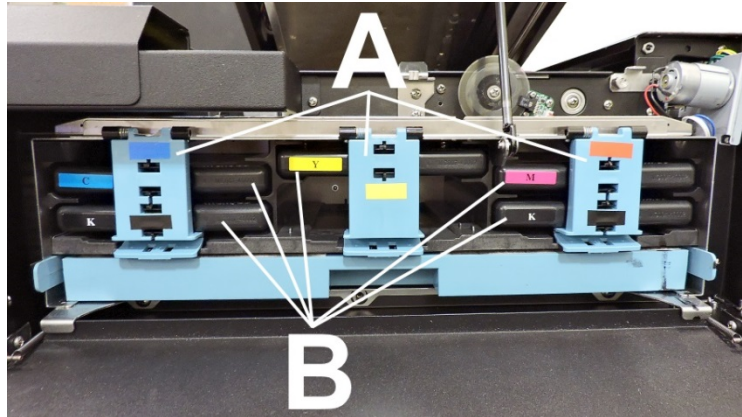

2. Clean Ink Level Prism [A] and QA Chip contacts [B] with a clean, dry, lint-free cloth.

NOTE: Dampen cloth with distilled water to wipe Prism, but DO NOT get QA Chip contacts wet.

3. Reinstall Ink Tank(s) (*labels up*), close Ink Tank Latch(es). Close Ink Tank Door.

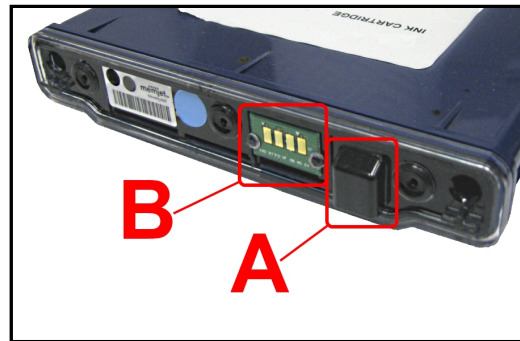

Storage

New Ink Tanks should be stored in original packaging and kept away from heat.

Opened Ink Tanks should remain in Printer.

Nominal Ink expiration date: 24 months following date of manufacture (*ink fill date*).

Disposal

Safely dispose of Ink and Ink Tanks in accordance with local/national regulations.

Clean up spills with soap and water. Abrasive soap is effective in cleaning ink off your hands.

Clean/Replace Printhead

Cleaning

The Printhead is cleaned automatically each time the Printer is turned on or when the “**Quick Clean Printhead**” routine is performed. This can be found under the “**Maintenance**” drop-down menu on **Touchscreen**. If running automated Cleaning Levels doesn’t help improve print quality, the Printhead can be cleaned manually.

1. **Open Top Cover.** From the Touchscreen, tap “**Service**” in the **Menu** drop-down, then tap “**System Deprime**”. The Printer pumps any ink in system back into Tanks. Then the Printhead Latch pops open.

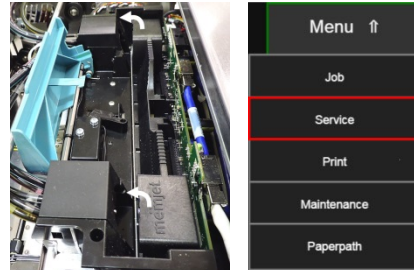

CAUTION

DO NOT PRY OR MANUALLY LIFT PRINTHEAD LATCH OR LATCH MAY BREAK. ONLY OPEN LATCH USING THE RELEASE PRINTHEAD BUTTON ON THE TOUCHSCREEN OR IN THE PRINTER TOOLBOX.

2. Make sure Printhead Latch is fully opened to retract ink lines. Remove used Printhead by tilting it toward ink lines, then carefully lifting it out of the Printhead Compartment.

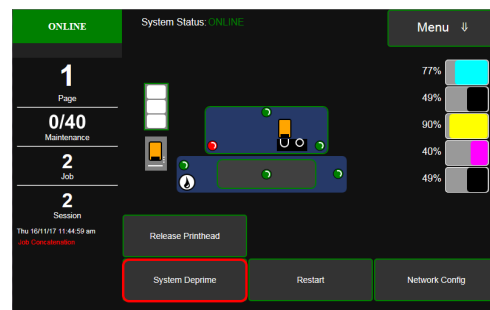

3. Moisten Printhead nozzles by slowly running deionized/distilled water (*reference ASTM D5127-90 Type E-II Electronic Grade Water*) over the nozzles, end to end (*gray strip located below orange strip*).

Take care not to damage copper contacts, metal plate, or gold Printhead surface.

4. Reinstall Printhead, close Printhead Latch and close Top Cover.

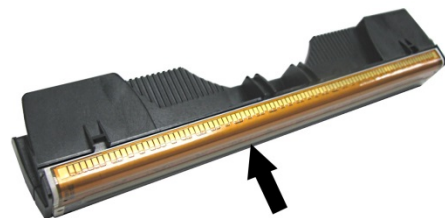

Generally, when ink supply is adequate and print quality remains poor or when automated cleaning processes or manually cleaning Printhead does not help image quality, replace Printhead.

CAUTION

- Use electrostatic discharge (ESD) protection when handling.
- Hold Printhead by handles **ONLY**.
- **DO NOT** touch ink couplings, nozzle surface or electrical contacts.
- **DO NOT** unpack Printhead until Printer is ready for installation. Once unwrapped, delay in installing Printhead can compromise print quality due to dehydration.
- **DO NOT** place an unwrapped Printhead on any surface before installing. Protect Printhead from scratches, dust, fibers, dirt and other contaminants at all times.

SECTION 4 MAINTENANCE

Replace Printhead

1. **Open Top Cover.** From the Touchscreen, tap “Service” in the Menu drop-down, then tap “System Deprime”. The Printer pumps any ink in system back into Tanks. Then the Printhead Latch pops open.

CAUTION

DO NOT PRY OR MANUALLY LIFT PRINTHEAD LATCH OR LATCH MAY BREAK. ONLY OPEN LATCH USING THE RELEASE PRINTHEAD COMMAND ON THE TOUCHSCREEN OR IN THE COMPUTER TOOLBOX.

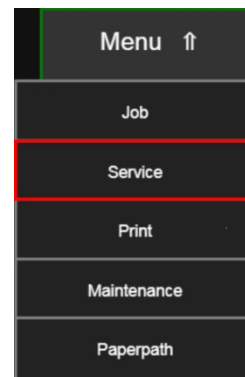

2. Make sure the Printhead Latch is fully opened to retract ink lines. Remove used Printhead by tilting it toward ink lines, then carefully lifting it out of the Printhead Compartment.

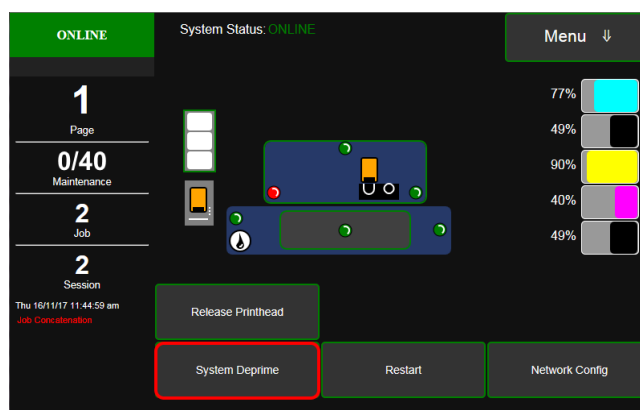

3. [A] Carefully remove Printhead from foil packaging. Tear foil at notch or cut the end with scissors.

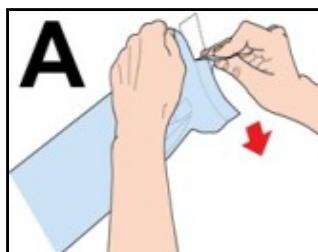

[B] Remove protective plastic cover. Hold Printhead by handle and unclip cover from Printhead.

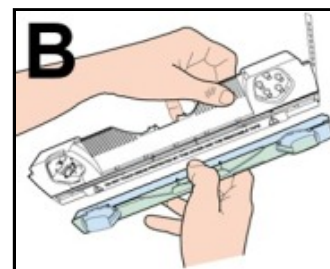

[C] Remove protective strip from Printhead electrical contacts. Once removed, DO NOT allow strip to touch electrical contacts.

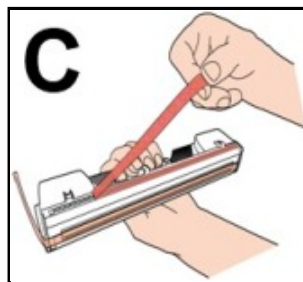

[D] Remove protective strip from Printhead Nozzles. Hold Printhead by handle. Pull strip tab and slowly peel strip from Printhead.

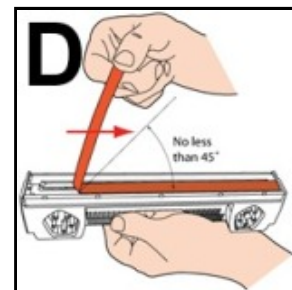

DO NOT pull strip at less than a 45° angle from Printhead surface.

DO NOT allow removed strip to touch Printhead Nozzles.

NOTE: Keep foil packaging and plastic cover to store or dispose of old Printhead.

- Carefully insert printhead into compartment at an angle [4], with Printhead surface facing down and Ink Nozzles facing Ink Hoses. Once seated, gently tilt printhead back until it snaps into an upright position [5].

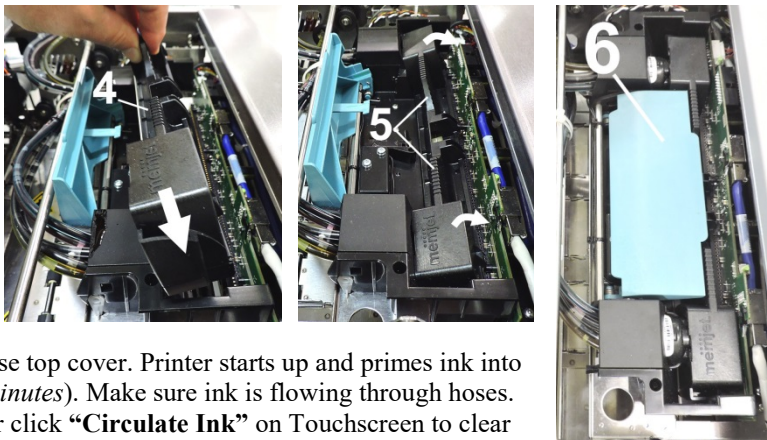

DO NOT FORCE the Printhead into position.

- Close Printhead Latch [6].** Close top cover. Printer starts up and primes ink into Printhead (*this may take a few minutes*). Make sure ink is flowing through hoses. If air bubbles appear, tap lines or click **“Circulate Ink”** on Touchscreen to clear them.

- Watch Control Panel Touchscreen.** Check that Printhead icon [7] in Printer image is primed (*solid color*).

- When **ONLINE [8]** appears, the Printer is ready for use.

NOTE: If the Printhead icon continues to display an outline or a question mark (?) try the following procedures:

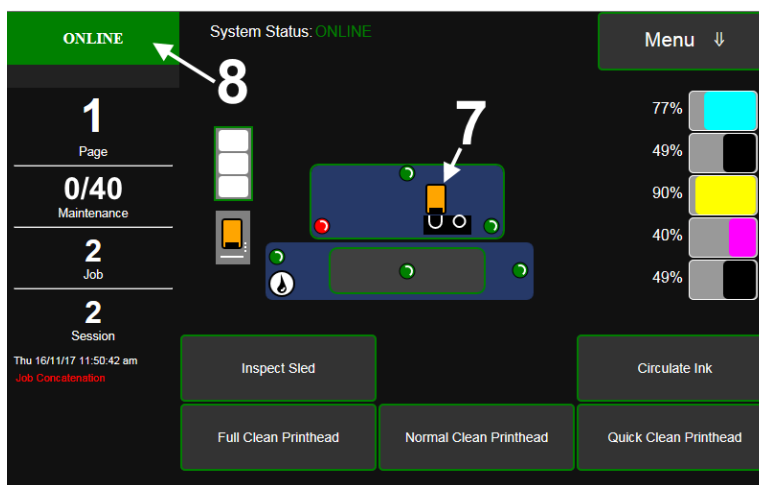

[1] Printhead icon shows an outline (*Printhead unprimed*): Click **“Circulate Ink”** under **“Maintenance”** drop-down in Printer Toolbox. If issue persists, try the **“Install Printhead”** procedure again. If this does not clear up the issue, call for technical support.

[2] Printhead icon displays a question mark (*Printhead not recognized*): Try the **“Install Printhead”** procedure again. If the issue continues, call for technical support.

NOTE: Printer may take up to 12 minutes to set itself up during initial startup. This is normal.

IMPORTANT!

CHECK INK TANKS. PRINTER MAY NOT FULLY REPRIME IF INK TANKS ARE LESS THAN 1/3 FULL.

SECTION 4 MAINTENANCE

Printhead Storage

Store and transport cartridge in original packaging, positioned as indicated by “**this side up**” arrow symbol on packaging.



Cartridge and ink supply must be within operating temperature range before attempting to prime cartridge with ink and starting to print. When stored at temperatures below operating range, it may take up to 3 hours for a cartridge in its packaging to reach operating temperature.

NOTE: Additional packaging will increase time needed to reach operating temperature.

Storage Life: 12 months from date of manufacture (*printed on shipping box*).

Storage Temperature Range:	Long Term: 14° F to 86° F (-10° C to 30° C) Short Term: -11° F to 140° F (-25° C to 60° C) NOTE: Cumulative storage duration above 86° F (30° C) must not exceed 72 hours.
Humidity Range:	5% to 95% Relative Humidity, non-condensing
Atmospheric Pressure Range:	70 kPa to 106 kPa
Electrostatic Discharge:	8 kV air discharges or 4 kV contact discharges* *When tested in accordance with IEC 61000-4-2

NOTE: See Appendix E for Printhead Best Practices

Inspect the Service Station

The Service Station (*located directly under the Printhead Assembly*) cleans Printhead of excess ink and debris, keeps Printhead hydrated and protected when not in use, captures and removes ink used to keep nozzles clear. It moves out of the way of the Printhead during printing. It is designed to provide a long service life.

To access the Service Station for inspection and cleaning:

1. Using the **Touchscreen**, select “**Menu**,” then tap “**Maintenance**” from the drop-down menu. Tap “**Inspect Sled**”. The Service Station [A] moves out from under the Printhead Assembly.
2. Open the Top Cover.

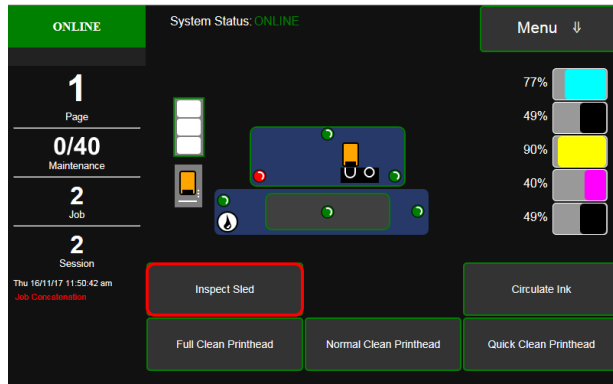

3. Visually inspect the Service Station for cleaning or service.

Use a dry, lint-free cloth to soak up any excess ink from the Capping Station [B].

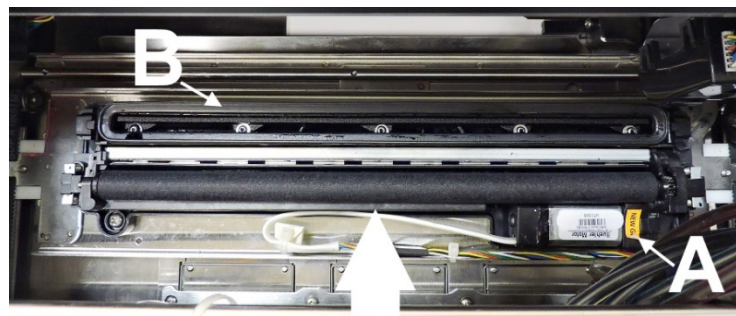

4. Tap “**End Inspection**” on the Touchscreen to move the Service Station back under the Printhead Assembly.
5. Close the Top Cover.

NOTE: Closing the Top Cover will also end the Inspection. If you don't need to visually verify the Service Station moving back into position, step 4 can be skipped.

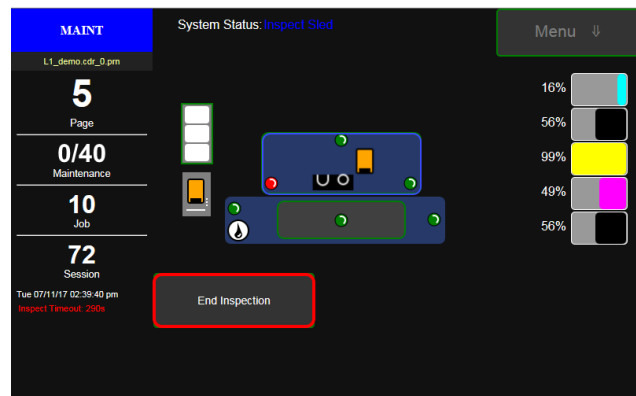

SECTION 4 MAINTENANCE

Replace Ink Waste Tray

Ink Waste Tray soaks up any excess ink that may drip from Print Engine during operation. After a period of time it may become saturated and need replacement.

1. Open Ink Tank Door.
2. Pull on tabs to slide Ink Waste Tray [A] out of Printer.
3. Replace with a clean or new Ink Waste Tray.

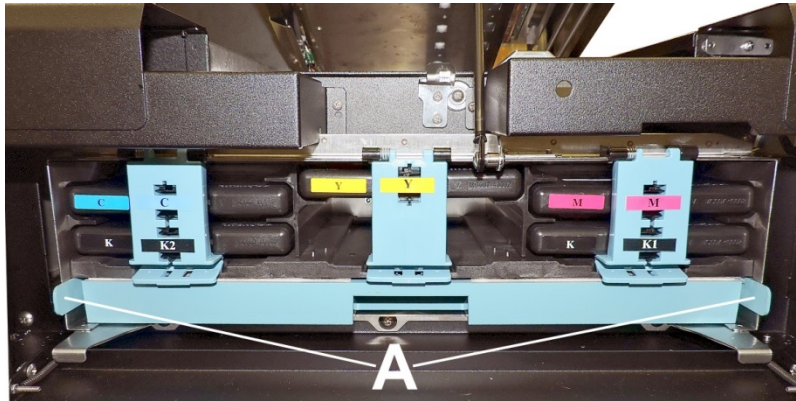

Remove Jammed Media

Clearing a jam depends on where jam occurred.

Print Area:

- Open Ink Tank Door.
- Pull Top Assembly Latch [A] toward you to unlatch Top Assembly.
- Raise Top Assembly [B].
- Clear jam, then carefully lower Top Assembly.

CAUTION
DO NOT ALLOW THE TOP ASSEMBLY
TO DROP OR SLAM CLOSED.

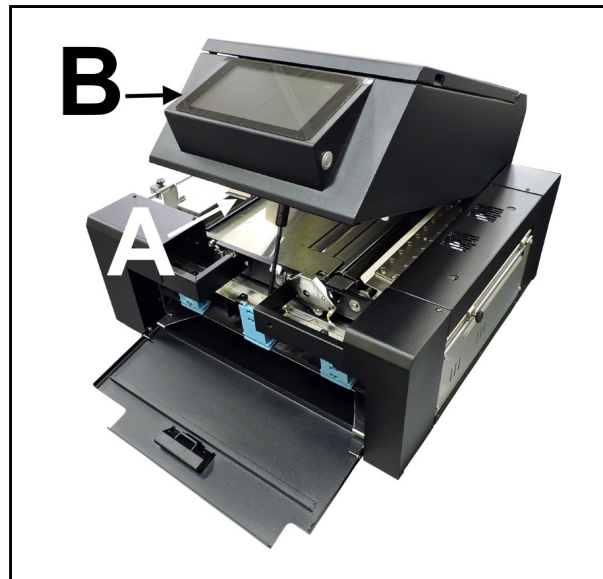

Misfeeds

To correct misfeeds:

Roll Feed – Unwinder/Winder may be moving too fast or slow for job being printed.

Readjust Speed Controls on Unwinder and Winder.

Fanfold – Straighten stack.

Cleaning

WARNING!

PRINTER IS A PRECISION MACHINE. CLEAN REGULARLY TO INSURE MANY YEARS OF SERVICE.

BEFORE PERFORMING ANY MAINTENANCE, DISCONNECT MACHINE FROM ITS POWER SOURCE!

DO NOT REMOVE SIDE COVERS! HIGH VOLTAGES PRESENT.

Clean Printer regularly to remove accumulated paper dust and ink. Depending on types of media run, paper dust may accumulate inside Printer and on Transport.

1. Turn Printer OFF and unplug it from power receptacle. Then open or remove Covers.
2. **Interior:** Use a vacuum with a soft brush attachment or a can of compressed air to help loosen dust particles.

NOTE: Be careful around ink tray and capping station in Print Engine area as accumulated ink may splash onto other parts of Printer. Take care not to damage PC Boards or electrical wiring.

3. **Exterior:** Wipe clean with a lint-free cloth using any standard nonabrasive household cleaner that does not contain plastic-harming solvents.

CAUTION

NEVER SPRAY OR POUR CLEANERS DIRECTLY ON OR INTO PRINTER!

EXCESS LIQUID COULD HARM ELECTRONIC PARTS.

DAMPEN A LINT-FREE CLOTH WITH THE CLEANER AND APPLY IT TO PARTS TO BE CLEANED.

Feed Rollers and Forwarding Rollers

Feed, Forwarding and Transport Rollers can become glazed with paper lint and ink from media.

Clean regularly with a mild abrasive household cleaner on a damp lint-free cloth.

NOTE: Avoid using solvents on Rubber Rollers.

SECTION 4 MAINTENANCE

Print Engine

Areas in Print Engine can become glazed with a buildup of dust, paper lint and accumulated ink and have to be cleaned regularly. Open Top Cover. Open Clamshell Assembly by releasing latch. Use a vacuum to pick up any loose debris.

NOTE: Be careful around Ink Tray and Capping Station in Print Engine area as accumulated ink may splash onto other parts of Printer. Take care not to damage PC Boards or electrical wiring.

CAUTION

**USE ONLY DEIONIZED/DISTILLED WATER TO CLEAN PRINT ENGINE COMPONENTS.
AVOID CONTAMINATING PRINTHEAD WITH CLEANERS, LUBRICANTS OR OTHER CHEMICALS.**

[A] Media Sensors: Paper lint and dust may build up on Media Sensors. Use a can of compressed air or a damp (*not wet*) foam or lint-free cotton swab to gently swab Sensors. Take care not to drip water into Circuit Boards. Use a clean, dry swab to dab surfaces dry.

[B] Rubber Rollers. Clean as needed using distilled water with a damp, lint-free cloth.

Be careful not to splash or drip ink on other parts of Printer.

[C] Printing Surfaces, Ink Drip Tray. Wipe using distilled water and a damp, lint-free cloth. Pat dry with a lint-free cloth.

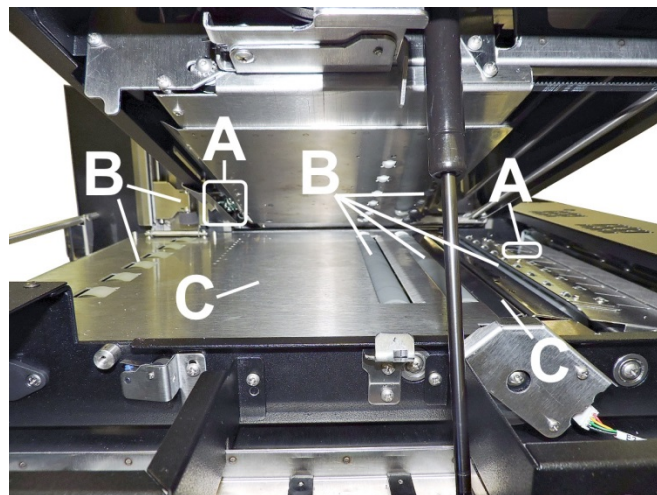

Media Bridge and Ink Drip Tray: Carefully remove Ink Drip Tray Cover and Ink Drip Tray.

DO NOT tip the Tray or ink may spill. Wipe off excess ink then clean using distilled water and a damp, lint-free cloth.

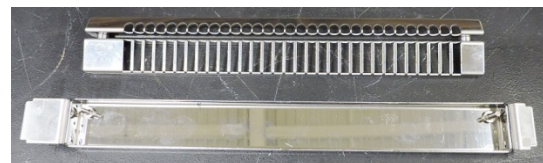

Clean Ink Revolver Couplings

1. First, Deprieme the system and remove the Printhead.
2. Moisten a foam swab in distilled water.
3. Insert the swab into one of the ink channels and rotate swab to clean chamber.
4. Use a new swab for each of remaining ink channels until all 10 openings are clean. (*5 on each side.*)

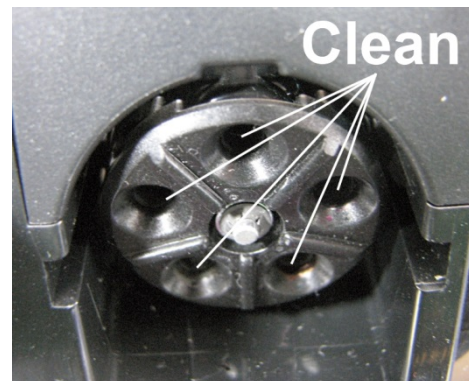

Shipping or Transporting Printer

If you have to ship or transport Printer for any reason, the unit will have to be prepared.

Once the Printer is prepared, carefully package the Printer, Printhead, Service Station and Ink Tanks in the original packaging.

Remove Printhead

1. From the Touchscreen, tap “Service” in the **Menu** drop-down, then tap “System Deprime”. The Printer pumps any ink in system back into Tanks. Then the Printhead Latch pops open. Then Printhead Latch pops open. Open top cover.

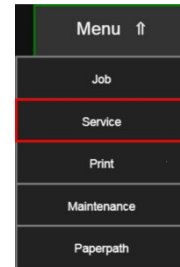

CAUTION

DO NOT PRY OR MANUALLY LIFT PRINthead LATCH OR LATCH MAY BREAK. ONLY OPEN LATCH USING RELEASE PRINthead BUTTON ON THE TOUCHSCREEN OR IN THE PRINTER TOOLBOX.

2. Make sure Printhead Latch is fully opened to retract ink lines. Remove used Printhead by tilting it toward ink lines, then carefully lifting it out of the Printhead Compartment.
3. Pack Printhead area with absorbent towels to catch any ink drips or spills. Carefully pack Cartridge using original packaging.

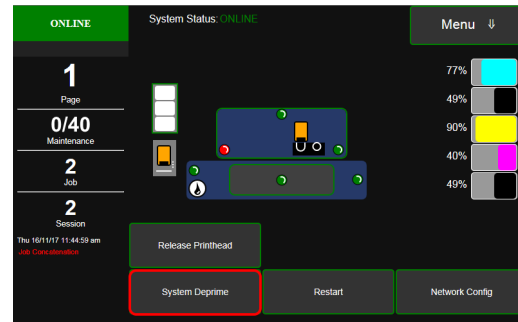

Empty and Clean Ink Drip Tray

1. **Open Top Assembly.**
2. Carefully lift the two tabs out of the slots in the Print Engine Frame and remove Ink Drip Tray Assembly [A].

DO NOT tip the Tray or ink may spill. Empty the Tray if necessary and wipe off excess ink. Clean using distilled water and a damp, lint-free cloth.

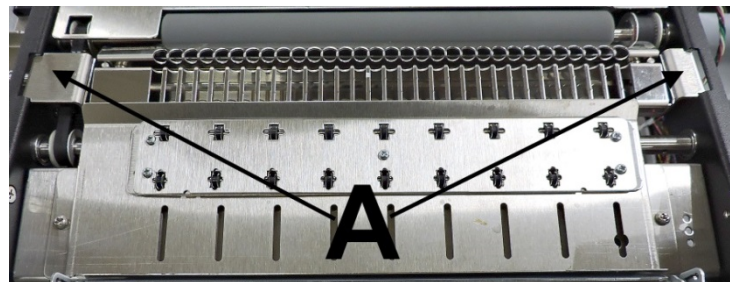

3. Reinstall the Ink Drip Tray Assembly.

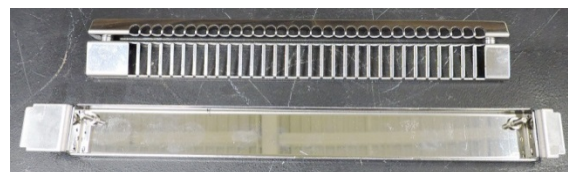

TURN PRINTER POWER OFF

CAUTION

WHENEVER POWERING DOWN UNIT, ALWAYS:

1. **PRESS POWER BUTTON ON CONTROL PANEL.**
2. **WAIT FOR PRINTER TO STOP PROCESSING.**
3. **THEN PRESS MAIN POWER SWITCH ON REAR PANEL.**

SECTION 4 MAINTENANCE

Remove Ink Tanks

1. **After de-priming the system.**
Open Front Cover (*hinged at bottom*). Open the Ink Tank Latches [A] and pull Ink Tank(s) [B] out of Printer.

2. Carefully package Ink Tanks in original packaging.

IMPORTANT: Make sure ink seals on Ink Tanks face up to prevent leakage.

3. Pack Ink Tank bays with absorbent towels to catch any ink drips or spills.

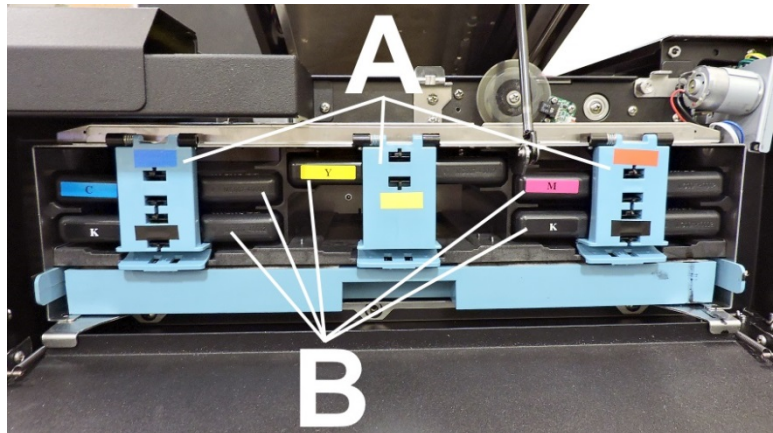

SECTION 5 – *Troubleshooting Guide*

Troubleshooting Guides are provided to assist in solving any problems that might occur with Printer. We tried to make them as complete as possible. The best advice we can offer is to make sure that system is set up properly, plugged in, and has an adequate supply of ink before attempting to troubleshoot any problem.

Memjet® Printhead

CONDITION	PROBLEM	SOLUTION
Missing parts of letters or text.	Air and bubbles blocking Nozzles.	Clean Printhead using recirculation, priming or cycles of depriming and priming found in Driver or Toolbox . Rehydrate Printhead using distilled water and a wet, clean, lint-free cloth. Air bubbles often disappear with Printer use.
Print shows regularly missing or misdirected nozzles or ink color mixing.	Debris on Printhead.	Perform startup routine. Clean Printhead using Cleaning Levels in Driver or Toolbox . Wipe Printhead manually with distilled water and a wet, clean, lint-free cloth. Replace Printhead.
Ink mixing – Mixed or muddy colors.	Causes: Ink flooding, air in Printhead or a dirty Printhead.	Clean Printhead using Cleaning Levels in Driver or Toolbox . Wipe Printhead manually with distilled water and a wet, clean, lint-free cloth.
No print or crisp blocks of missing drops.	Electrical failure or poor electrical connection.	Reseat Printhead. Replace Printhead.
System will not re-prime ink after replacing Printhead	Printhead nozzles dry. Ink Tanks may be 1/3 full or less.	Wipe Printhead manually with distilled water and a wet, clean, lint-free cloth. Replace Ink Tanks.

WARNING!

**DO NOT REMOVE SIDE COVERS OF PRINTER!
HIGH VOLTAGES PRESENT BEHIND COVERS!**

**SECTION 5
TROUBLESHOOTING**

Printer

CONDITION	PROBLEM	SOLUTION
Ink Tank installed, no Ink Level indication in Toolbox	Ink Tank contacts dirty, preventing Printer/Ink Tank communication.	Remove Ink Tank(s). Clean prism and QA Chip contacts, see Maintenance, Cleaning Ink Tank Contacts .
Extra lines; losing data	Database problem.	Check data in database program.
Improper output	Wrong interface settings. Static electricity. Dirty Media Sensor.	Check software or database on PC. Close software, then turn Printer OFF and ON. Clean Media Sensor.
Media jams	Media is curled or bent. Media is too thin.	Uncurl media. Minimum media thickness is 0.1mm (0.004").
No communication	Improper cabling / connector. Unit not receiving power.	Use proper USB cable. Check plug connections, ON/OFF button and fuse on back panel.
Print too light or missing character dots	Clogged or dirty Printhead. Running out of ink.	Check Printhead. Check Ink Tanks.
Blurry text/image 	Image is not sharp.	Clean Printhead using Cleaning Levels in Driver or Toolbox . Clean Printhead manually using distilled water and a wet, clean, lint-free cloth.
Job is sent to print but does not print.	Printer not turned ON. Printer not connected to computer. Media Sensor is covered in Print Engine.	Check that Printer is ON. Connect printer cable to computer and resend job. Open Print Engine and remove media.

Errors and Warnings

Printer Alert Window Messages

Messages sent from Driver and displayed on PC screen in a small popup window.

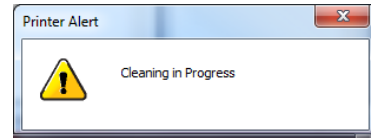

MESSAGE	SOLUTION
Cleaning in Progress	Wait until message disappears. Printer will start printing your job once cleaning process is complete.
Incompatible Printhead	Remove and reinsert your Printhead. Replace Printhead. Printheads must be purchased from authorized supplier for this printer model.
Incorrect ... Ink Tank	Replace Ink Tank. Ink Tanks must be purchased from authorized supplier for this printer model.
... Ink Low Example: Black Ink Low	Reorder Ink.
... Out of Ink Example: Cyan Out of Ink	Replace empty Ink Tank.
Load Paper	Out of Paper. Load media into Printer and press PAUSE/RESUME button to resume printing.
Mechanical Jam	Check for and remove obstruction, then press PAUSE/RESUME button to resume printing. Check/Clean Sensors. If problem persists, contact technical support.
Missing Printhead	Remove Printhead. Check/clean electrical contacts. Reinsert Printhead. Replace Printhead. If problem persists, contact technical support.
Multiple Inks Low	Reorder Ink.
Multiple Ink Tanks Out	Replace empty Ink Tanks.
Multiple Ink Tanks are missing	Insert missing Ink Tanks. Clean electrical contacts and reseal Ink Tanks.
Multiple Unauthorized Ink Tanks	Remove and reinsert Ink Tank. Replace Ink Tank. Ink Tanks must be purchased from authorized supplier for this printer model.
Paper Jam	Remove jammed media. Check for proper feed setup then press PAUSE/RESUME button to resume printing. Check/Clean Sensors. If problem persists, contact technical support.
Printhead Latch Open	Ensure that Printhead is inserted properly, then close Printhead Latch so that it locks.
Print Zone Assembly (Top Assembly) Open	Check to be sure Top Assembly is completely closed and latched. Make sure Print Engine Latches are secure.
The ... Ink Tank is missing	Insert missing Ink Tank. Clean electrical contacts and reseal Ink Tank.
Unauthorized ... Ink Tank Installed	Replace Ink Tank. Ink Tanks must be purchased from authorized supplier for this printer model.
Unauthorized Printhead	Replace Printhead. Printheads must be purchased from authorized supplier for this printer model.

SECTION 5 TROUBLESHOOTING

Toolbox System Status Messages

Use the **Touchscreen** or **Toolbox** screen to quickly determine and locate a problem in the Printer. **Status Indicator** shows **ERROR** in red box. **Printer Graphic Icon** highlights Printer and system affected.

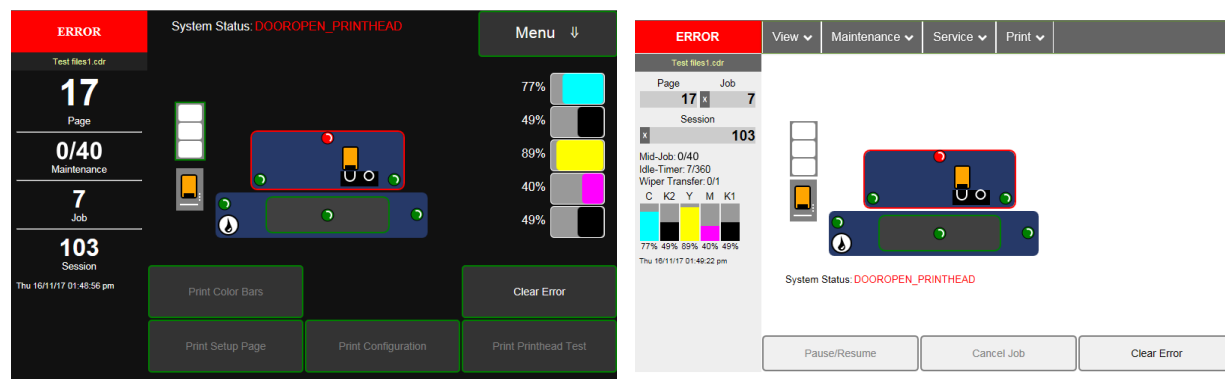

The **System Status** information displays the basic problem (*in red*). **Ink Levels** displays ink status. **Control Buttons** (*at screen bottom*) let you perform often used tasks without leaving the screen.

Listed below are some of the messages that may appear in **System Status**.

SYSTEM STATUS	SOURCE	SOLUTION
System Status: PAPERPATH_FEED_TIMEOUT	Out of Paper Media is not reaching Print Engine. Hesitation in media feed.	Load media into Printer and press Pause/Resume button to resume printing. If media is present; check/adjust Guides.
System Status: PAPERPATH_FEED_TIMEOUT or System Status: PAPERPATH_PAPERJAM	Paper/Media jam detected. Printer has detected that one (<i>or both</i>) Media Sensors are blocked (<i>interrupted</i>).	Carefully remove jammed media from Printer and close Print Engine. System Status message in red should go away. Toolbox Paperpath Sensor indicators should change from red to green. After jam is cleared, you can: Press Pause/Resume to resume printing. Press Cancel Job to cancel job, then manually clear job from computer's print queue.
System Status: DOOROPEN_FRONT	Indicates that the Top Assembly is open. Sensor cable unplugged.	Verify that Top Assembly is closed and securely latched. Make sure that Top Assembly switch (<i>located to the left of the Top Assembly latch catch</i>) is activated by the tab on the Top Assembly. Use Scan Sensors in Toolbox to check that Top Assembly switch is functioning.
System Status: DATA_PATH_UNDERRUN	Media is not moving from Entry Sensor to Exit Sensor within a specified time. Possible issue with format or orientation of job being sent. Dirty Encoder Wheel.	Check/clean Transport Rollers. Check/clean Sensors. Try changing orientation setting in software/driver or setting a different media size. Check/clean Encoder Wheel. If problem persists contact technical support.

Toolbox System Status Messages (*Continued*)

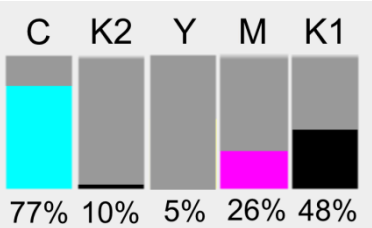
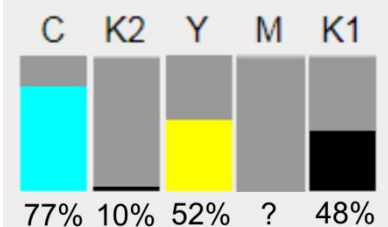
SYSTEM STATUS	SOURCE	SOLUTION
<p>System Status: INK_LOW</p>	<p>X = Color. One or more Ink Tanks are low on ink.</p>	<p>Ink Tank replacement will be necessary soon. Reorder Ink.</p>
<p>System Status: INK_OUT_YELLOW</p>  <p>C K2 Y M K1 77% 10% 5% 26% 48%</p>	<p>X = Color. One or more Ink Tanks are out of ink.</p>	<p>Open the Ink Tank Door. Replace empty Ink Tank(s). Verify that Ink Tanks are seated firmly and latches are fully closed. Close Ink Tank Door and ink levels should fill in.</p>
<p>System Status: MAINTENANCE_BUSY</p>	<p>Machine is performing a maintenance procedure.</p>	<p>No action required.</p>
<p>System Status: CARTRIDGE_MISSING_MULT</p>  <p>C K2 Y M K1 77% 10% 52% ? 48%</p>	<p>Ink Tank is missing or not recognized (<i>obtained from an unauthorized reseller</i>). If correct ink, check contacts.</p>	<p>Insert missing Ink Tank or pop Ink Tank in and out to improve connection. Press Pause/Resume button to refresh ink levels and continue printing.</p>
<p>System Status: MECH_FAIL_PERMANENT</p> <p>ERROR on System Status screen.</p> <p>Check the Printer Graphic to determine what component has a problem or failed: Service Station, Ink Valve, or Printhead (usually indicated with a steady "?")</p>	<p>Mechanical error One of Printer's mechanical components was not properly registered at expected position. Mechanical failure or Sensor failure.</p>	<p>Visually inspect component indicated as a "Reason" for failure. Using Scan Sensors screen on the Touchscreen or Toolbox, perform toggle test on Sensor responsible for registration of failed mechanical component position. Lifter Arm Sensor is dirty or damaged, Lifter Motor Cable is unplugged, operator's side Lifting Arm is damaged, or Lifting Arm mechanism is stuck. Dual Pinch Valve problem: Check Sensor board connector and flag/sensors alignment. Check Valve motor connector. Check the P2005 cable on MPCA. At this point, this error may represent an Ink Pump error, since there is no return signal from pump and therefore, a separate message describing an Ink Pump error.</p>

**SECTION 5
TROUBLESHOOTING**

Toolbox System Status Messages (Continued)

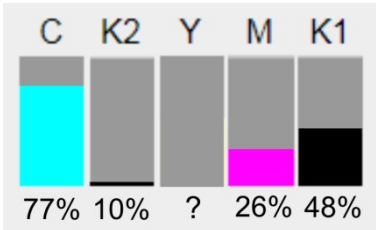
SYSTEM STATUS	SOURCE	SOLUTION
<p>System Status: ONLINE ERROR on System Status screen. Printer Graphic shows Printer Service Station as “?”.</p>	<p>Service Station is ejected, Service Station position sensors are damaged or malfunctioning.</p>	<p>Check Service Station position. Using Scan Sensors page in Touchscreen or Toolbox, perform toggle test on two Sensors responsible for registration of Service Station position.</p>
<p>System Status: PRINTHEAD_MISSINGQA</p>  <p>C K2 Y M K1 77% 10% ? 26% 48%</p>	<p>Printhead missing and one or more of Ink Tanks are missing, When this error occurs, Multiple EWS monitoring is disabled.</p>	<p>Check Printer Graphic and Ink Levels displaying “?”. Install Printhead. Install Ink Tanks.</p>
<p>System Status: PRINthead MISSING ERROR on System Status screen. Printer Graphic shows Printer Printhead as “?”.</p>	<p>No Printhead installed or Printhead not making proper connections. J2001 cable unplugged. Printhead Latch is open.</p>	<p>If Printer was just powered on, wait a minute; error may clear by itself. Install Printhead. Remove and reinstall Printhead. Replace Printhead. Refer to appropriate sections in this manual for removing and installing Printhead.</p>
<p>System Status: PRINthead_UNPRIMED</p>	<p>Printhead priming process has failed.</p>	<p>If Printer was just powered on, wait a minute; error may clear by itself. Remove Printhead, wet print nozzles using deionized or distilled water and reinstall Printhead. Refer to appropriate sections in this manual for removing and installing Printhead. If you continue to have trouble priming Printhead; check for kinked or pinched color tubes.</p>
<p>System Status: MECH_CANCELPAGE</p>	<p>Job was cancelled by user pressing Cancel Job button.</p>	<p>Wait until print job has cleared from Printer. Then manually clear job from computer's print queue. Then send new print job. If problem persists, contact service support.</p>

Toolbox System Status Messages (Continued)

SYSTEM STATUS	SOURCE	SOLUTION
System Status: WIPER OVERTEMP	Wiper Motor is overheated due to performing a Wiper Transfer (<i>removing excess ink off Service Station Wiper</i>) too often or for multiple or extended periods. Printer will continue maintenance after Wiper Motor cools down. Message will disappear once the temperature returns to operating range.	Wait for Wiper Motor to cool down, Printer will automatically resume operation. NOTE: If running a number of short jobs or jobs on smaller media, reset Mid-Job Servicing interval to a higher number of pages.
System Status: WIPER ERROR	Wiper Roller is not turning. This can be due to: 1. White flex cable is dirty, broken or not connected. 2. Wiper Module (motor) failure. 3. DPCA failed at J17 terminal.	1. Check white flex cable and connections. 2. Replace Wiper Module. 3. Check and/or replace DPCA board.

Technical Support Contact Information:

Email: support@afinialabel.com

PH: 952-556-1608

APPENDIX

Appendices

Appendix A – Printer Specifications

PRINT RESOLUTION	Best: 1600 x 1600 DPI Normal: 1600 x 800 DPI
PRINT SPEED	High Quality Mode: 6" (15 cm)/second Normal Quality Mode: 12" (30 cm)/second
MEDIA PRINTSIZE	8.5" (215.9 mm) W x Continuous Length
MEDIA TYPES	Roll or Fanfold (<i>Label, Tag</i>)
MEDIA SIZE	Minimum: 2" W x 2" L (50.8 mm x 50.8 mm) Maximum: 9" (228.6 mm) W x Continuous Length
MEDIA THICKNESS	Minimum: 3 points (0.1 mm) Maximum: 12 points (0.3 mm)
MIN. LABEL GAP (Space between Labels)	No Bleed: 3 mm Full Bleed: 6 mm
MEDIA SENSING	Label gap, notch, tick mark, (Continuous, blackmark, diecut)
SOFTWARE	Windows™ Printer Drivers for Windows™ 7, 8, 8.1, 10. RIP available
INK	Water-based ink. 5 individual 250 ml ink tanks (CKMYK)
PRINTHEAD	Memjet® Replaceable Printhead
INTERFACE	USB 2.0 and Ethernet
ELECTRICAL	115-240 VAC, 50/60 Hz
DIMENSIONS	20.25" W x 22.25" L x 13.5" H (51.4 cm x 56.5 cm x 34.3 cm)
WEIGHT	75 lbs. (34 kg)
OPERATING TEMPERATURE	15°C to 30°C (59°F to 86°F). Maximum change ±0.5°C (0.9°F)
OPERATING HUMIDITY	35% to 80% Relative Humidity, non-condensing

All specifications subject to change without notice

Appendix B – Supplies and Optional Hardware

The following supply items and optional hardware are available from your Afinia Label Printer Distributor:

SUPPLIES	
Item	Afinia Part #
L901 Black Ink Tank	26730
L901 Cyan Ink Tank	26723
L901 Magenta Ink Tank	26716
L901 Yellow Ink Tank	26709
L901 Printhead	26730
OPTIONAL HARDWARE	
XL Unwinder	26681
XL Rewinder	29110

APPENDIX

Appendix C – Borderless Printing: Borderless Print vs. Oversize

Afinia L901 Print Driver (under Printing Preferences) offers two ways for printing to the edge of the media, sometimes called “borderless” or “full-bleed” printing. Each option adjusts the relationship between the target image, selected media size and the actual media on which is it printed, but in different ways. Each option has advantages and disadvantages, especially for certain types of images.

- **Borderless Print checkbox:** In **General Tab**, under **Media** section.
- **Oversize checkbox:** In **Custom Sizes** dialog box, under **Size** section in **General Tab** of **Print Preferences**.

Details about each option: when to use each, prerequisite setup and other tips for getting the best result.

BORDERLESS PRINT CHECKBOX

Borderless Print Checkbox is located in **Printers Printing Preferences**, in **Media** section under **General Tab**

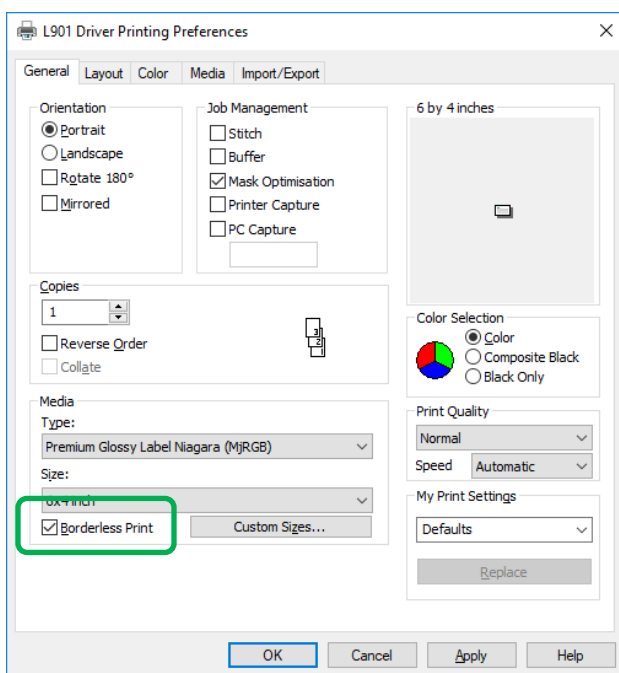

Borderless Print Checkbox on General Tab in Printing Preferences

Impact of Using Borderless Print

Selecting **Borderless Print** scales target image beyond the size of selected media, by adding a **Borderless** default resolution value set in the Printer Driver. The image is stretched to print larger than actual size.

For example, if the **Borderless** default setting is *21 (dots)*, then resultant the **Borderless Print** selection will have a resolution of *821 dpi*, (when printing with normal resolution of *800*). Although this might stretch the image beyond the edges of the media (and is quick and easy to select), the printed image may not have the same aspect ratio as the artwork and may be too distorted to use.

Prerequisites for Borderless Print

Since scaling without maintaining the aspect ratio can distort the image, do not use **Borderless Print** for targets that have barcodes or text because this setting could render them unreadable. If target image is a photograph or other graphical image, scaling may not be noticeable or objectionable. Make test runs and check effect of choosing **Borderless Print**.

For example, **Borderless Print** for a 4" x 8" label would actually be:

$$4'' (800 \text{ dpi}) + 21 \text{ dots} = 3221 \text{ dots} \times 8'' (800 \text{ dpi}) + 21 \text{ dots} = 6421 \text{ dots}$$

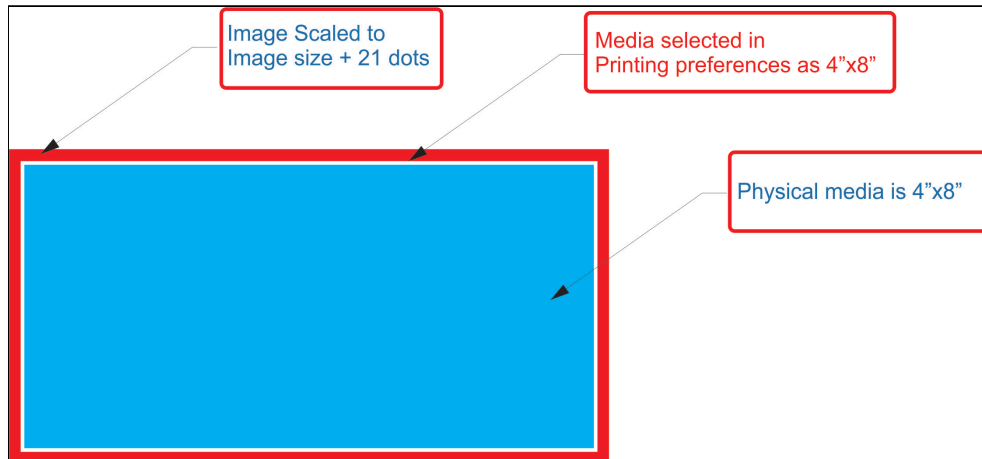

Borderless Print Example: Measurements and Relationships

For barcodes and text, use **Oversize** instead of **Borderless Print**.

Required preparation for **Oversize** is explained below.

OVERSIZE SETTINGS

Oversize checkbox is in **Custom Sizes** dialog box, located in **Printing Preferences** under **General Tab**.

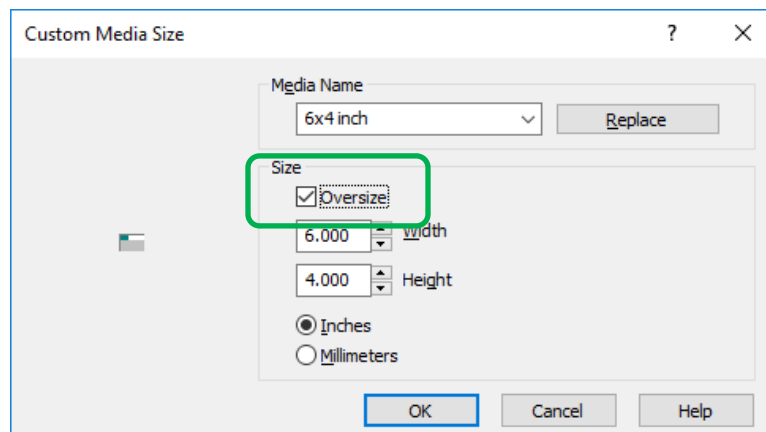

Oversize Checkbox on Custom Media Size Dialog Box

- Select **Oversize checkbox**.
- Enter measurements of physical media in Width and Height fields, selecting units (*inches or millimeters*).

APPENDIX

Page Setup for Oversize

When using **Oversize** option, **Resizing** (located in *Layout Tab of Driver*) needs to be set to “**Original Size**”.

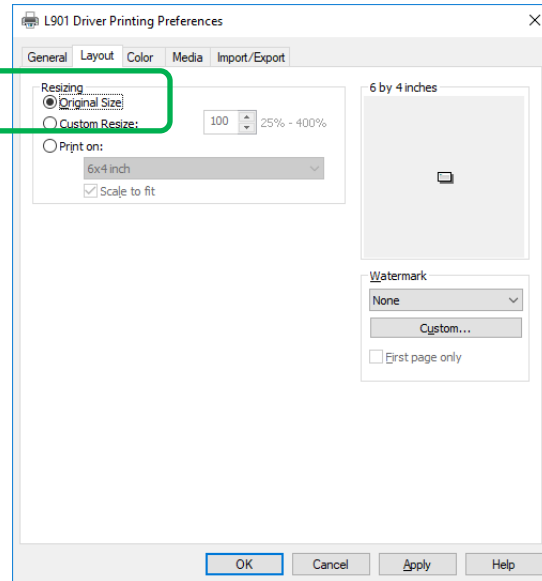

Page Setup for Oversize Option

Impact of Using Oversize

Selecting **Oversize** extends **Custom Sizes** dimensions beyond that of actual media being printed on. Since this size extension is equal in both X- and Y- axes, there is no distortion of target image. Instead, choosing **Oversize** opens up more of target image for printing, so that it can print beyond size of physical media. However, target image also needs to be created as oversized, not size of physical media; otherwise, there is likely to be a white border between image and media.

Prerequisites for Oversize

To make **Oversize** an applicable option:

- Target image needs to be greater in size than size of actual media. Image needs to be same size as custom media size selected in **Custom Sizes** window, corresponding to additional amount set as default in Driver.

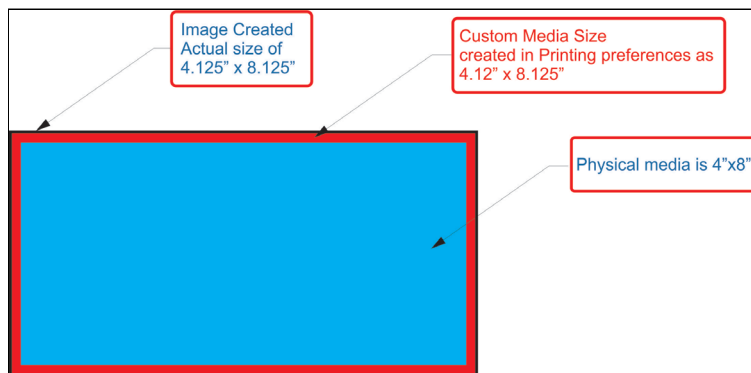

Oversize Example:

Relationships

Measurements and

ADDITIONAL CONSIDERATIONS AND TIPS

Some additional considerations apply to both **Borderless Print** and **Oversize** in certain circumstances.

Minimum Label Gap and Maximum Width

For both **Borderless Print** and **Oversize**, additional consideration and testing are required when approaching limitations for minimum label gap and maximum label width.

- **Minimum label gap for Full Bleed is 6mm.** If media used has only a 3mm gap between labels, borderless printing (*either **Borderless Print** or **Oversize***) may not work without skipping a label between printed labels. An image that goes beyond physical media size effectively reduces label gap, possibly below 3mm minimum. This may also be beyond **top of form (TOF)** and **bottom of form (BOF)**. If gap is less than minimum label gap, labels are skipped since **TOF** and **BOF** are undetectable for next label.
- **Black mark media, full bleed.** A .25” gap in between cut labels, using a .125” printed black mark. The matrix needs to be left on the material.
- **Maximum print width is 8.69”**, including physical media width + **Borderless Print/Oversize** additional width. If borderless printing is required, physical media needs to be narrow enough to include additional width for **Borderless Print** or **Oversize** expansion.

Page Sizing and Handling with Adobe Acrobat

Many target images are in PDF format. When printing from Adobe Acrobat, be sure to select only **Actual Size** under **Page Sizing & Handling**. Other options will affect settings already made for **Borderless Print** and **Oversize**, producing undesirable results.

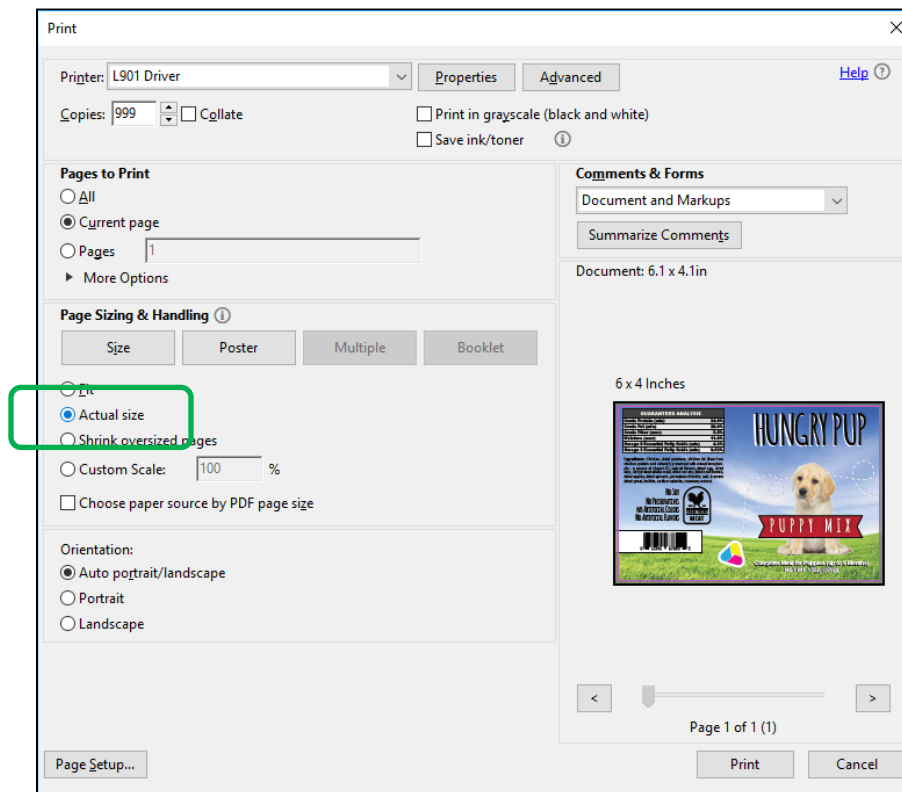

Printing Borderless Print/Oversize from Adobe Acrobat: Select “Actual Size”

APPENDIX

Appendix D – External Connections – GPIO details

Pinout Details:

Pin 1 – 3.3v
Pin 2 – open
Pin 3 – Print job ready – output.
Pin 4 – External Device Ready – Input. Active Low
Pin 5 – Printer error – Output. Active High
Pin 6 – Ground
Pin 7 – Reverse paper path direction – Output
Pin 8 – End of Roll – Input. Active Low
Pin 9 – Open

Pin 4 can be used as a pause input. The pause input is an active low input (IAL). When it is not asserted the pin should be high (3v3) and when asserted, it is low (0v). Connect a 1k resistor to 3v3 (pins 4 and 1). A switch can be connected and when pressed (active), pin 4 is set to 0v and will pause the printer. Releasing the switch will set the signal to 3.3v and the printer goes back online.

Pin 5, printer error, will change from 0V to 3.3V when offline.

Timing Diagram:

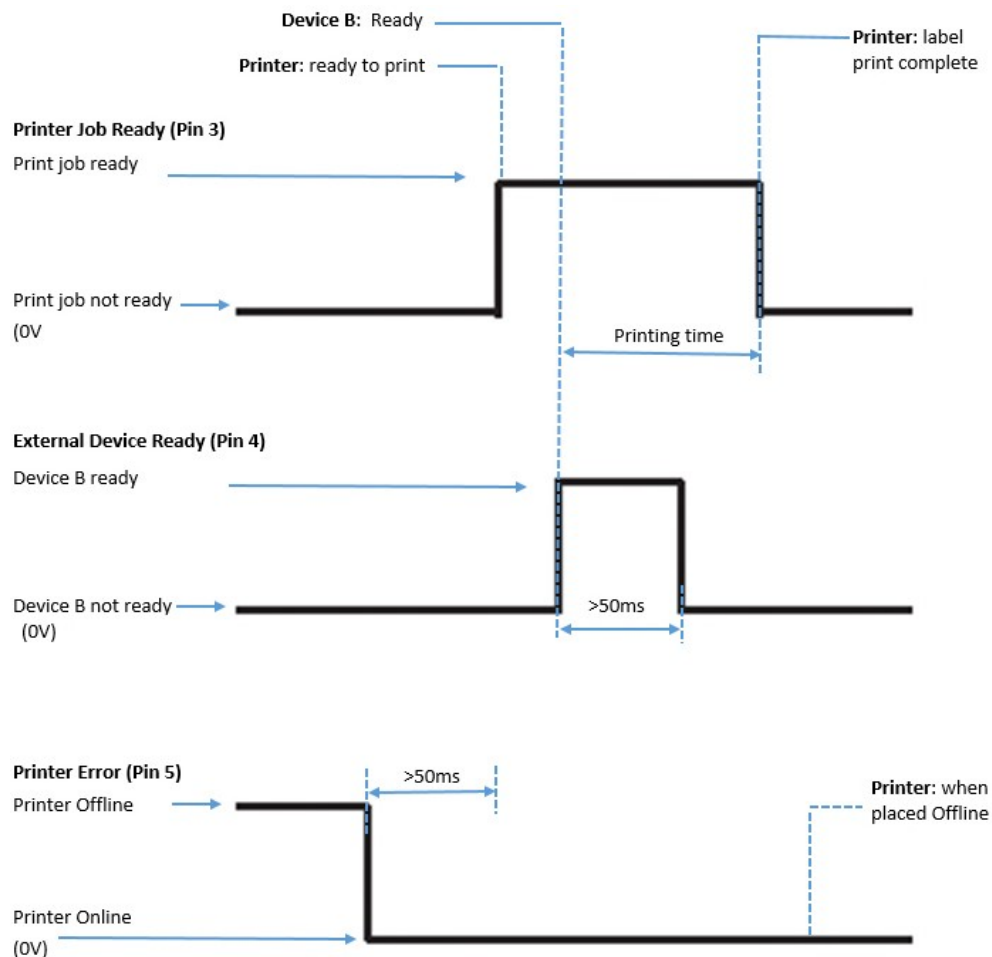

Appendix E – Memjet Printhead Best Practices

Storage & Installation

- Always store right side up, as indicated by the box label
- Install PH within one year of manufacturing date
- Save the orange plastic cap from new packaging for later use
- Replace the microfiber roller with each new PH

Inactivity

- **1-6 days inactive:**
- Keep printer powered on at night and weekends
- **7+ days inactive:**
- Remove and store PH in orange plastic cap with distilled/deionized water

NOTE: With regular operation, PH nozzles remain hydrated as ink flows through the system. For this reason, heavy users get the most life out of their printheads. If you are light user, try to print every day.

In addition, regularly using as much of the print width as possible will increase the output potential of each PH. For narrow label situations, this is achieved using multiple-up labels and a slitter.

Environment

- Operating: 59°–95°F (15°–35°C); Relative humidity: 35–80%
- Storage: 23°–113°F (-5°–50°C); Relative humidity: up to 85%, non-condensing at 65°
- Maintain a clean and dust-free environment
- Use media that is clean and free of dust and adhesive residue

Maintenance

- **Perform regular maintenance** — Keep printer and media path clear of paper dust and adhesive residue buildup.
- **Limit air exposure** — If PH nozzles will be exposed for longer than 30 seconds, remove PH from printer and store in orange plastic cap with distilled/deionized water.
- **Manual clean** — Use distilled/deionized water and lint-free cloth. **NEVER** use alcohol or paper towels to wipe the PH. **NEVER** touch the nozzles.
- **Use KWS** — Keep default KWS settings and adjust—if needed—based on environment.

APPENDIX

A

Adjustable

Media Guide	2
Media Sensor	2, 4

B

Backup

Logs	37
Print Jobs	37

Borderless Print vs. Oversize Printing	74
--	----

C

Cartridges

Ink Tank	5, 16, 53, 64
Printhead	3, 17, 55, 63

Choose Location	6
-----------------------	---

Clean

Ink Drip Tray	62
Ink Revolvers	62
Ink Tank Contacts	54
Media Sensors	62
Print Engine	62
Printer	61
Printhead	55
Rollers	61, 62
Service Station	59

Color Tab, Printer Driver	23
---------------------------------	----

Connect

Computer	8
Network	2, 8
Printer	8
USB	2, 8, 10

Control Panel

Power Button	1
Touchscreen	1, 2, 27

Couplings, Ink Revolver	3
-------------------------------	---

Cover, Top	1, 2
------------------	------

Cutter Assembly	1
-----------------------	---

D

Date and Time, Toolbox	46
------------------------------	----

Debug Logs, Toolbox	49
---------------------------	----

Diagnostic Port	2
-----------------------	---

Diagnostics, Toolbox	45
----------------------------	----

Display, Touchscreen	1, 2
----------------------------	------

Disposal, Ink Tanks	54
---------------------------	----

Door, Ink Tank	1, 2
----------------------	------

Drip Tray	4
-----------------	---

Drop-Down Menu	38
----------------------	----

Job (Status)	28
--------------------	----

Maintenance	52
-------------------	----

Media Scan	33, 50
------------------	--------

Paperpath	32
-----------------	----

Print	52
-------------	----

Service	52
---------------	----

System Test	35
-------------------	----

Touchscreen	27
-------------------	----

View	39
------------	----

Wiper	35
-------------	----

E

Encoder	4
---------------	---

Error Messages	67
----------------------	----

Ethernet Port	2
---------------------	---

Exhaust Fan	1, 4
-------------------	------

Exit Sensor	4
-------------------	---

Exit Wheels	4
-------------------	---

External Device, Connect	20
--------------------------------	----

F

Fans, Exhaust	1, 4
---------------------	------

Forwarding Rollers	2, 4
--------------------------	------

Fuse	2
------------	---

G

General Tab	22
-------------------	----

Guides

Adjustable Media	1, 2
------------------------	------

Fixed Media	2
-------------------	---

Media Exit	1
------------------	---

I

Import/Export Tab, Printer Driver	26
---	----

Ink Drip Tray	4, 62
---------------------	-------

Ink DripTray Assembly	7
-----------------------------	---

Ink Revolvers	3
---------------------	---

Ink Revolvers, Clean	62
----------------------------	----

Ink Tanks	1, 5
------------------------	------

Clean Contacts	54
----------------------	----

Disconnect Switch	5
-------------------------	---

Disposal	54
----------------	----

Door	1, 2
------------	------

Install	16
---------------	----

Latches	1, 5
---------------	------

Remove/Replace	53, 64
----------------------	--------

Storage	54
---------------	----

Ink Usage, Toolbox	44
--------------------------	----

Ink Waste Tray	1, 5, 60
----------------------	----------

Inspection Motor	3
------------------------	---

Install

Ink Drip Tray Assembly	7
------------------------------	---

Ink Tanks	16
-----------------	----

Printer Driver	9
----------------------	---

Printer Driver Over USB	9
-------------------------------	---

Printer Driver, Network	11
-------------------------------	----

Printhead, First Time17

Interface Port

 Connecting20

 Unwinder2

J

Job

 Backing Up37

 Uploading37

Job (System Status), Touchscreen28

Job Library, Printer29

Job Logs, Toolbox49

L

Latches

 Ink Tanks1, 5

 Printhead3

 Top Assembly1, 4, 5

Layout Tab23

Library, Printer Job29

Lifter Motor3

Location, Choose6

Logs

 Backing up37

 Debug Files49

 Job Files49

M

Main Power Switch2

Maintenance53

Maintenance, Drop-Down Menu52

Maintenance, Touchscreen32

Media Guides

 Adjustable1, 2

 Exit1

 Fixed2

Media Scan

 Toolbox50

 Touchscreen31, 33

Media Sensor

 Adjustable Entry2, 4

 Clean62

 Exit4

Media Tab, Printer Driver24

Minimum Requirements, System9

Misfeeds60

N

Network Connect2, 8

Network Settings

 Toolbox46

 Touchscreen31

O

Operating Printer21

Optional Hardware73

P

Package Contents6

Paperpath, Touchscreen32

Platen, Print4

Power Button1

Power Connect2

Print Engine

 Clean62

 Ink Revolvers3, 62

 Latch1, 5

 Latch, Top Assembly4

 Service Station3

 Top Assembly1, 2

Print Jobs

 Backing Up37

 Uploading37

Print, Drop-Down Menu52

Print, Touchscreen31

Printer

 Clean61

 Connect8

 Cutter Assembly1

 Drip Tray4

 Encoder4

 Ethernet Port2

 Exit Wheels4

 Fuse, Main2

 Ink Drip Tray Assembly7

 Ink Tanks1, 5

 Main Power Switch2

 Maintenance53

 Operating21

 Optional Hardware73

 Print Platen4

 Receptacle, Power2

 Service Port2

 Set-up6

 Shipping/Transporting63

 Specifications72

 Supplies73

 Support Strut4

 Touchscreen1, 2, 27

 Transport Rollers4

 Troubleshooting66

 Unpack6

 Unwinder Interface Port2

 USB Port2

 Using Printer Job Library29

Printer Driver

 Borderless Print vs. Oversize74

 Color Tab23

 General Tab22

 Import/Export Tab26

 Install9

 Layout Tab23

INDEX

Media Tab	24	Service, Drop-Down Menu.....	52
Network Install	11	Service, Touchscreen.....	31
Properties	21	Set-up	
USB Install.....	9	Network Settings.....	46
Printer Toolbox		Printer	6
Date and Time.....	46	Shipping/Transporting Printer	63
Debug Logs.....	49	Specifications, Printer.....	72
Diagnostics	45	Starwheel Assembly, Exit.....	4
Drop-Down Menu.....	38	Storage	
Ink Usage	44	Ink Tanks	54
Maintenance Drop-Down Menu	52	Printhead	58
Media Scan	50	Supplies, Printer	73
Print Drop Down Menu	52	Support Strut.....	4
Scan Sensors	51	Switch	
Service Drop-Down Menu.....	52	Ink Tank Disconnect	5
Service Menu	45	Main Power.....	2, 8
System Settings.....	46	Top Assembly	4
System Status.....	40	System Requirements, Minimum	9
User Interface.....	41	System Settings, Toolbox	46
Using.....	38	System Status, Toolbox	40
View Drop-Down Menu	39	System Test, Touchscreen	35
Printhead	3	T	
Clean	55	Toolbox	
Install First Time.....	17	Drop-Down Menu.....	38
Latch	3	Top Assembly	1, 2
Lifter Motor	3	Latch	4
Remove/Replace	55, 63	Support Strut	4
Storage	58	Switch	4
Troubleshooting	65	Top Cover	1, 2
R		Touchscreen	
Receptacle, Power	2	Display.....	1, 2
Remove/Replace		Drop-Down Menu.....	27
Ink Tanks	53, 64	Job (System) Status.....	28
Ink Waste Tray.....	60	Maintenance.....	32
Jams, Printer.....	60	Media Scan	31, 33
Printhead	55, 63	Network Configuration	31
Rollers		Paperpath	32
Clean	61, 62	Print.....	31
Exit.....	4	Service	31
Forwarding.....	2, 4	System Test.....	35
Transport.....	4	Using.....	27
S		Using Reprint	29
Scan Sensors, Toolbox	51	Wiper	35
Sensor		Transport Rollers	4
Adjustable Media Entry	2, 4	Tray, Drip	4
Clean	62	Tray, InkWaste	1
Exit.....	4	Troubleshooting.....	65
Service Menu, Toolbox	45	Errors and Warnings	67
Service Port	2	Printer	66
Service Station	3	Printhead	65
Clean	59	U	
Inspect.....	59	Unpack.....	6
Inspection Motor.....	3	Unwinder	
Position	63	Interface Port.....	2

Uploading		Using Printer Toolbox	38
Print Jobs	37	Using Printer Touchscreen	27
USB		V	
Backup Logs	37	View, Drop-Down Menu	39
Backup Print Jobs	37	W	
Uploading Print Jobs.....	37	Warning Messages.....	67
USB Port.....	2, 8, 10	Waste Tray, Ink	5, 60
User Interface, Toolbox.....	41	Wiper, Touchscreen.....	35
Using			
Reprint-Printer's Job Library.....	29		

Click here for more information!



IPSi

**INTEGRATED
PRODUCTIVITY
SYSTEMS**



(844) 477-4911 | www.ipsiscan.com

Copyright © 2018 AFINIA LABEL.

01/25/2018

L901
