



WS2 Series Printer

Operator Manual

WS208 / WS212



WS2_Operator_Manual_ENG_06

© 2020 SATO Corporation. All rights reserved.

FCC ID

In a domestic environment this product may cause radio interference in which case the user may be required to take adequate measures.

FCC Warning

This equipment has been tested and found to comply with the limits for a Class A digital device, pursuant to Part 15 of the FCC Rules. These limits are designed to provide reasonable protection against harmful interference when the equipment is operated in a commercial environment. This equipment generates, uses, and can radiate radio frequency energy, and if not installed and used in accordance with the instructions in this manual, it may cause harmful interference to radio communications. Operation of this equipment in a residential area is likely to cause harmful interference in which case the user will be required to correct the interference at his own expense.

This device complies with Part 15 of the FCC Rules. Operation is subject to the following two conditions: (1) this device may not cause harmful interference, and (2) this device must accept any interference received, including interference that may cause undesired operation.

FCC Statement for Optional RF module

This device complies with RF radiation exposure limits set forth for an uncontrolled environment.

The antenna used for this transmitter must be installed to provide a separation distance of at least 20 cm from all people and must not be collocated or operating in conjunction with any other antenna or transmitter.

WARNING

Changes or modifications not expressly approved by the party responsible for compliance could void the user's authority to operate the equipment.

(for USA only)

Liability Disclaimer

SATO Corporation takes steps to assure that the company's published engineering specifications and manuals are correct; however, errors do occur. SATO reserves the right to correct any such errors and disclaims any resulting liability. In no event shall SATO or anyone else involved in the creation, production, or delivery of the accompanying product (including hardware and software) be liable for any damages whatsoever (including, without limitation, damages for loss of business profits, business interruption, loss of business information, or other pecuniary loss) arising out of the use of or the results of use of or inability to use such product, even if SATO has been advised of the possibility of such damages.

Caution

Any changes or modifications not expressly approved by the party responsible for compliance could void the user's authority to operate the equipment.

Contents

1	Introduction	1
1.1	Features.....	1
1.2	Unpacking.....	2
1.3	Understand your printer	3
1.3.1	Perspective view	3
1.3.2	Back view	4
1.3.3	Interior view.....	5
1.4	Printer lights.....	6
1.4.1	Status lights.....	6
1.4.2	System mode.....	8
2	Get started	9
2.1	Attach the power cord	9
2.2	Turn on/off your printer	10
2.2.1	Turn on your printer.....	10
2.2.2	Turn off your printer	10
2.3	Load media.....	11
2.3.1	Prepare media.....	11
2.3.2	Place a media roll.....	12
2.3.3	Test media feed	15
2.4	Media types.....	16
2.5	Media sensing	18
2.5.1	Transmissive sensor	18
2.5.2	Reflective sensor	19
3	Printer operation.....	20
3.1	Printing Media Calibration & Configuration	20
3.2	Self test.....	21
	Option Parts	28
3.3	Reset your printer	32
3.4	Communications	33
3.4.1	Interfaces and Requirements.....	33
4	Maintenance	34
4.1	Cleaning.....	34
4.1.1	Printhead.....	34
4.1.2	Media housing	35
4.1.3	Sensor.....	35
4.1.4	Platen roller.....	36

5	Troubleshooting	37
5.1	Printer issues	37
5.2	Media issues.....	38
5.3	Other issues.....	39
6	Set Up Interface Connection by SATO WS2 Printer Utility.....	40
6.1	Install SATO WS2 Printer Utility.....	40
6.2	Work with SATO WS2 Printer Utility.....	42
6.2.1	Menu bar.....	43
6.2.2	Toolbar	45
6.2.3	Navigation pane	49
6.3	Update firmware	79
6.3.1	Update via the USB Client or COM port.....	80
6.3.2	Update via the LAN or Multi-LAN port.....	85
6.4	Update firmware via the USB host.....	90
6.5	Update firmware in Atmel mode	90
7	Specifications	94
7.1	Printer.....	94
7.2	Media	95
7.3	Electrical and operating environment.....	95
7.4	Physical dimension	95
7.5	Fonts, Barcodes, and Graphics	96
7.6	Ethernet	99
7.7	Wireless LAN (Option).....	99
7.8	Bluetooth (Option).....	101
7.9	Ports	102
7.9.1	USB	102
7.9.2	Ethernet	103

1 Introduction

Thank you for purchasing an SATO WS2 Series industrial barcode printer. This manual provides information about how to set up and operate your printer, load media and solve common problems. Illustrations are provided to help you quickly become familiar with the printer.

1.1 Features

- **Clamshell design, easy loading**
The WS2 series features a user-friendly clamshell design that allows users to simply open the cover and loading media.
- **Compact size**
Small footprint design, the compact WS2 series fits into tight spaces and supports a wide range of applications.
- **Enhanced connectivity**
The WS2 series has built-in USB host, USB device, and Ethernet.

1.2 Unpacking

Make sure all of the following items are included in your package.

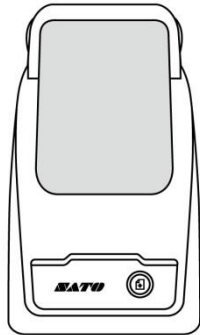

SATO WS2 Printer



User Documents
(Quick Guide, Warranty,
etc.)

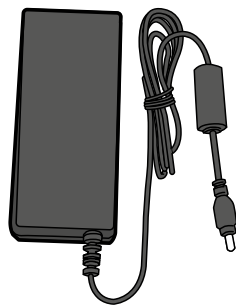

Power Supply



AC Power Cord

When you receive the printer, open the package immediately and inspect for shipping damage. If you discover any damage, contact the shipping company and file a claim. SATO is not responsible for any damage incurred during shipping. Save all package materials for the shipping company to inspect.



Note If any item is missing, please contact your local dealer.

1.3 Understand your printer

1.3.1 Perspective view

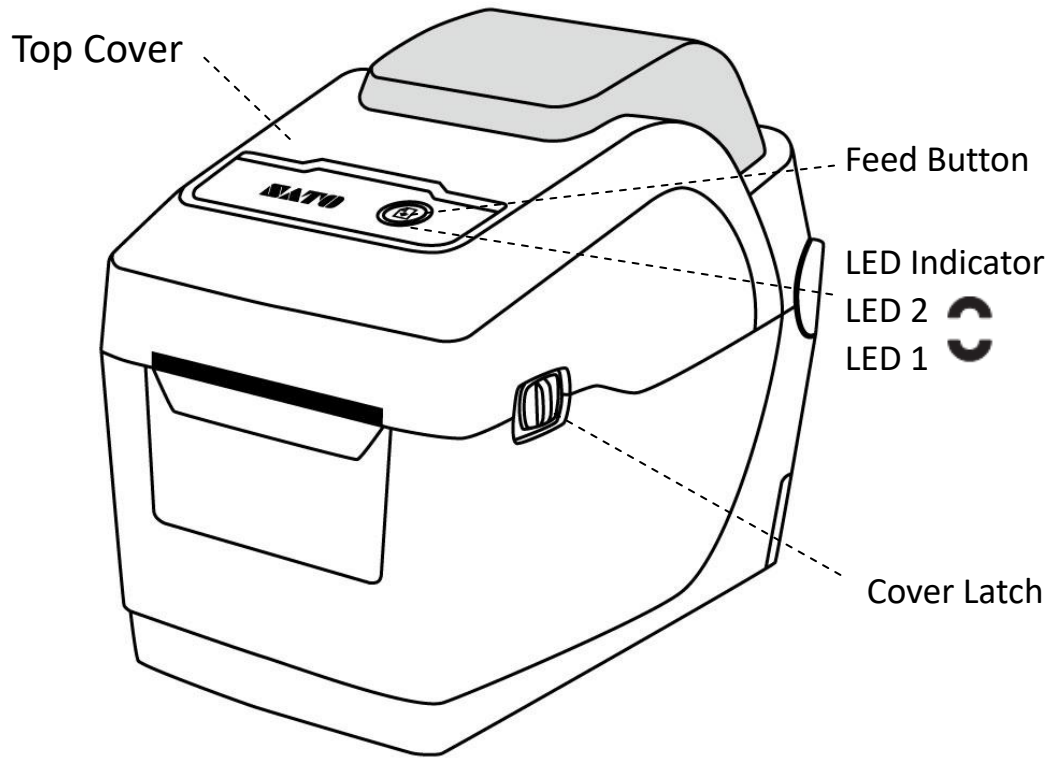

1.3.2 Back view

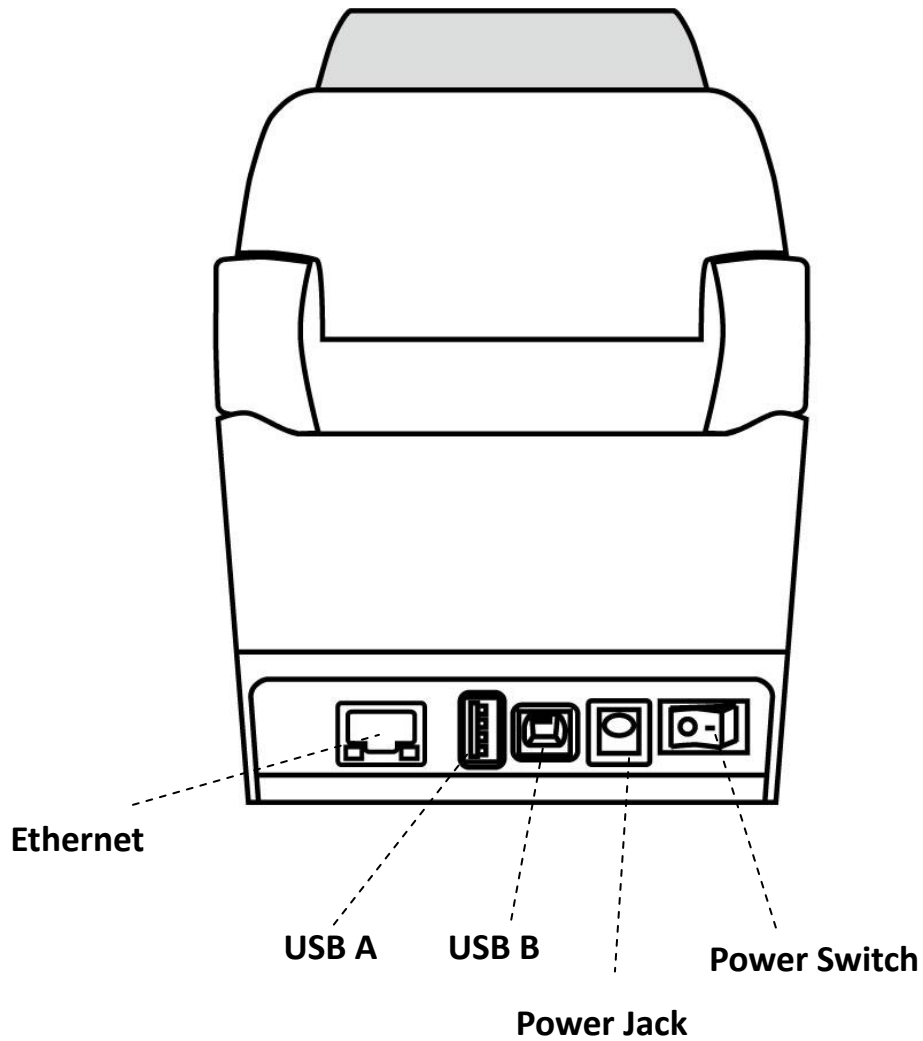

Caution To avoid injury, be careful not to trap your fingers in the Paper Slot while opening or closing the Top Cover.

1.3.3 Interior view

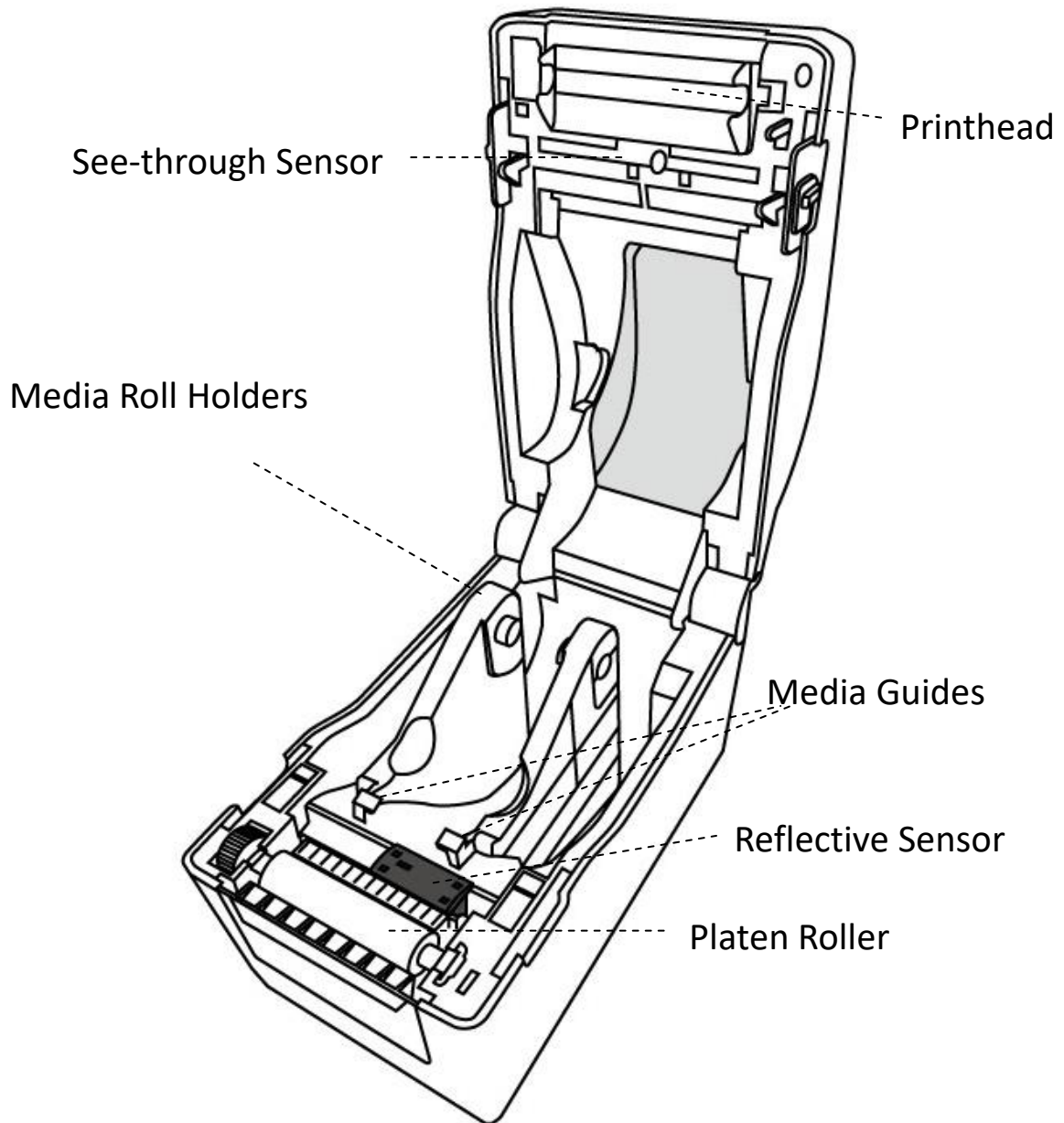

1.4 Printer lights

There are two LED lights that show the status of WS2 Series printer. The Upside light is defined in LED2. LED1 is below LED2 and Feed symbol.



1.4.1 Status lights

Status lights help you check printer's condition. The following tables show the blinking speed of status lights and the conditions they indicate.

Symbol	Blinking Speed	Blinking Interval
**	Fast	0.5 Second
*	Slow	2 Seconds
* LED2 + *LED1	Slow	LED2 & LED1 Blinking Interval at same time
* LED2 + LED1*	Slow	LED2 & LED1 Blinking Interval at different timing

LED 2	LED 1	Description
Green	Green	The printer is ready to print.
Green	** Green	The printer is transmitting data.
* Green	* Green	In pause.
* Green	Green *	The printer is writing data to the flash or USB memory. The USB memory is being initialized.
Green	Orange	Head high temperature.
Green	* Orange	The RTC battery is low. (If the printer has a built-in RTC)
Green	** Orange	The print module is opened when the printer is turned on.
Orange	Orange	Paper jam.
** Orange	** Orange	The media is out when the print data is sent to the printer. Paper end.

1 Introduction

** Orange	Orange **	Ribbon end or ribbon error (for thermal transfer models)
Red	Orange	The printhead is broken.
Red	**Orange	Cutter error (with optional cutter).
Red	Red	Cover (Thermal Head) open error during printing.
Red	* Red	An EEPROM for backup cannot be read or written properly.
		A command has been fetched from an odd address.
		Word data has been accessed from a place other than the boundary of the word data.
		Long word data has been accessed from a place other than the boundary of the long word data.
Red	** Red	Command error.
* Red	Red *	Flash ROM on the CPU board error or USB memory error.
		An erase error has occurred when formatting the USB memory.
		Unable to save files due to insufficient USB memory.

1.4.2 System mode

The system mode consists of status light color combinations. It contains a list of commands for you to select and run.

To enter the system mode and run the command, do the following:

1. Turn off the printer.
2. Press and hold the **FEED** button, and turn on the printer.
3. Both status lights glow solid Orange for a few seconds. Next, they turn to green shortly, and then turn to other colors.
4. When status lights show the color combination you need, release the **FEED** button immediately.
5. Press the **FEED** button to run the command.

The following table is the command list of the system mode.

LED 1	LED 2	Command
Green	Red	Transmissive Sensor Calibration (Section 3.1)
Green	Orange	Reflective Sensor Calibration (Section 3.1)
Red	Red	Resetting Your Printer (Section 3.3)
Red	Orange	Reserved
Red	Green	Reserved
Orange	Red	Reserved
Orange	Green	Self-Test (Section 3.2)

2 Get started

This chapter describes how to set up your printer.



Caution Do not use your printer in areas exposed to splashing water or any other liquid.



Caution Do not drop your printer, or place it in an area subject to humidity, vibration or shock.

2.1 Attach the power cord

1. Make sure the power switch is set to the **OFF** position.
2. Insert the power supply's connector into the printer power jack.
3. Insert the AC power cord into the power supply.
4. Plug the other end of the AC power cord into the wall socket.

Important Use only power supplies listed in the user instructions.

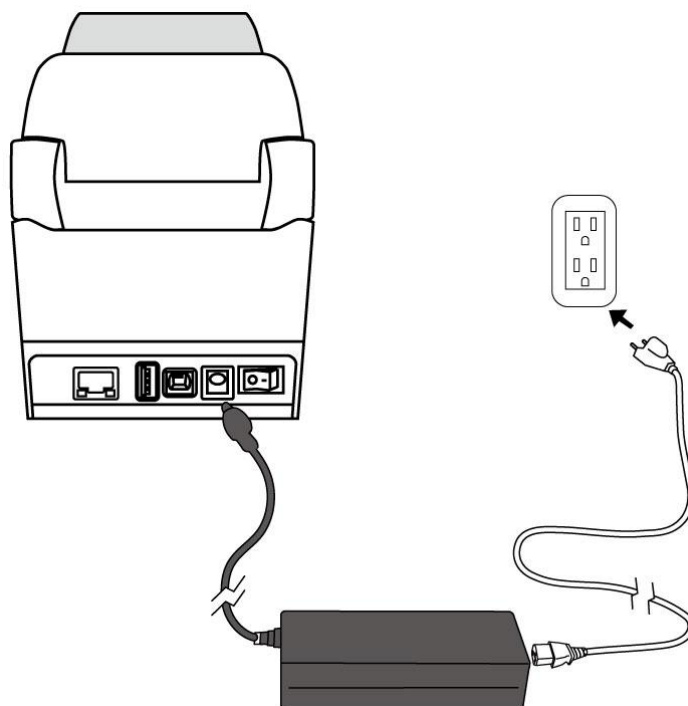

Warning Do not plug the AC power cord with wet hands, or operate the printer and the power supply in an area where they may get wet. Serious injury may result from these actions!

2.2 Turn on/off your printer

When your printer is connected to a host (a computer), it is good to turn on the printer before turning on the host, and turn off the host before turning off the printer.

2.2.1 Turn on your printer

1. To turn on your printer, turn on the **Power Switch** as below. The “I” is the **ON** position.

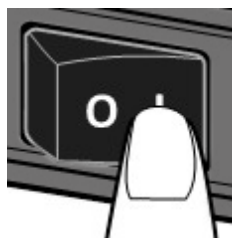

2. Both status lights glow solid Orange for a few seconds, then turns to solid green.



Note If you connect the printer to the internet or insert a USB drive before turning on the printer, it will take longer for the printer to enter the online mode after you turn it on.

2.2.2 Turn off your printer

1. Make sure LED is solid green before turning off the printer.
2. To turn off your printer, turn off the **Power Switch** as below. The “O” is the **OFF** position.

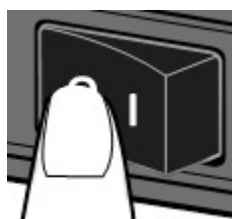

Caution Do not turn off your printer during data transmission.

2.3 Load media

There are various types and sizes for the media roll. Load the applicable media to satisfy your need.

2.3.1 Prepare media

The inside wound and outside wound media roll can be loaded into the printer the same way. In case the media roll is dirty during shipping, handling or storage, remove the outside length of the media. It helps avoid dragging adhesive and dirty media between the printhead and platen roller.

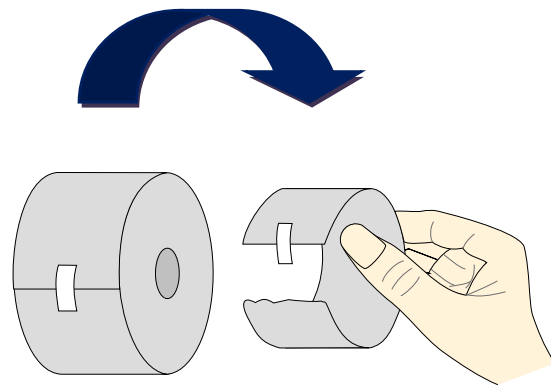
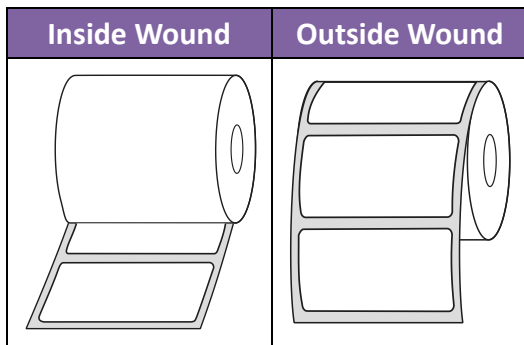

2.3.2 Place a media roll

1. Pull the head latch to open the top cover of the printer.

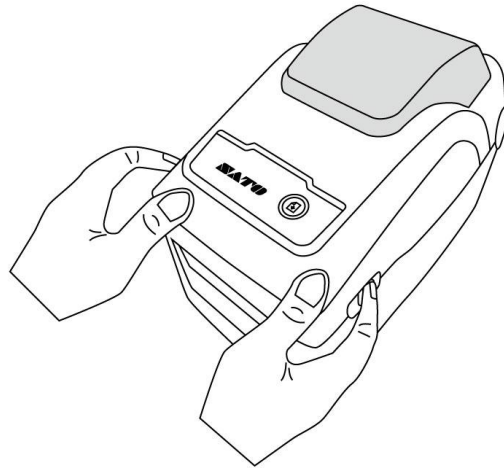

2. Pull the **Media Roll Holders** to slide them outward, and place the media roll between the holders. Make sure the print side is up, and the media roll is clamped tightly by the holders.

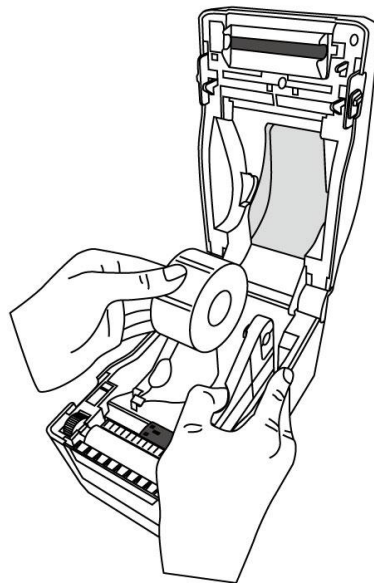

2 Get started

3. Pull the media until it reaches out of the printer. Thread the media under the media guides.

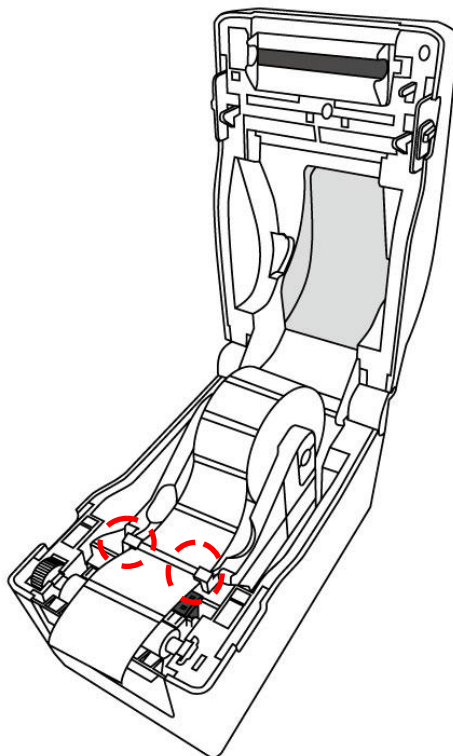

4. Close the top cover on both sides.

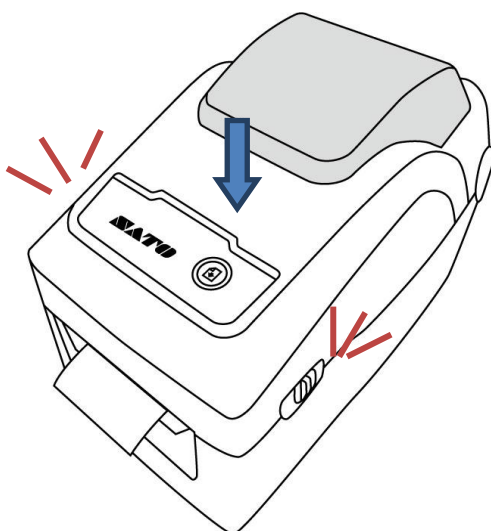

Flexibility

If you usually use the same width media or fanfold media, scroll the “Media Roll Holder Wheel” to adjust width to the same media guide.

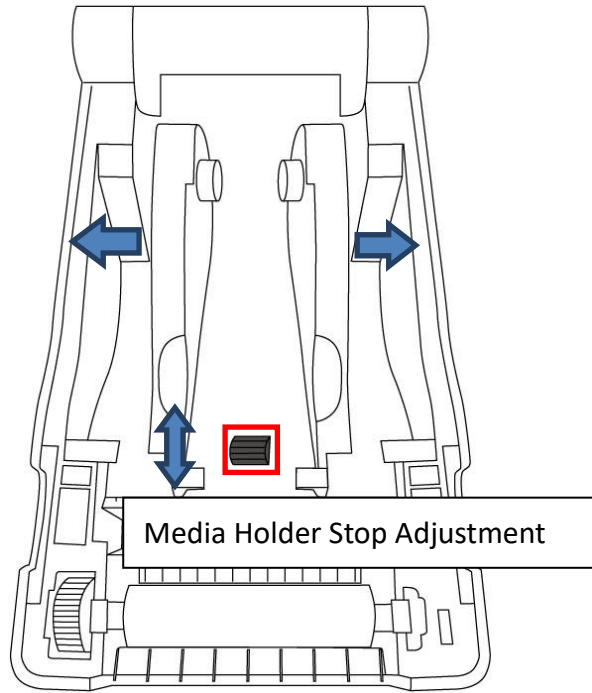

2.3.3 Test media feed

1. Turn on the printer, and press the **FEED** button to feed a label.

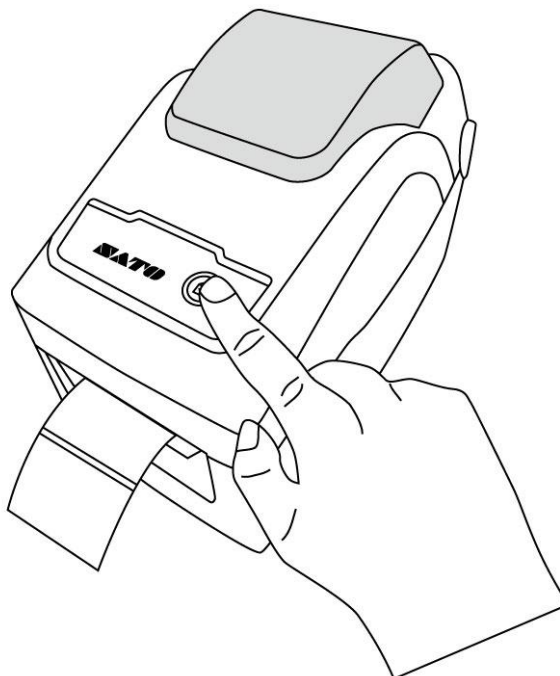

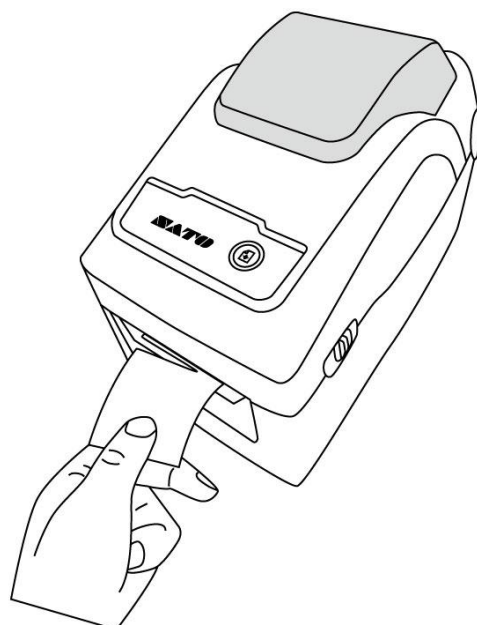

2. Flip the media and tear it along the edge of the front cover.

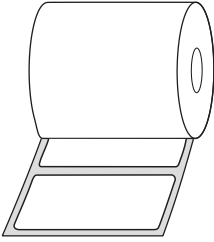
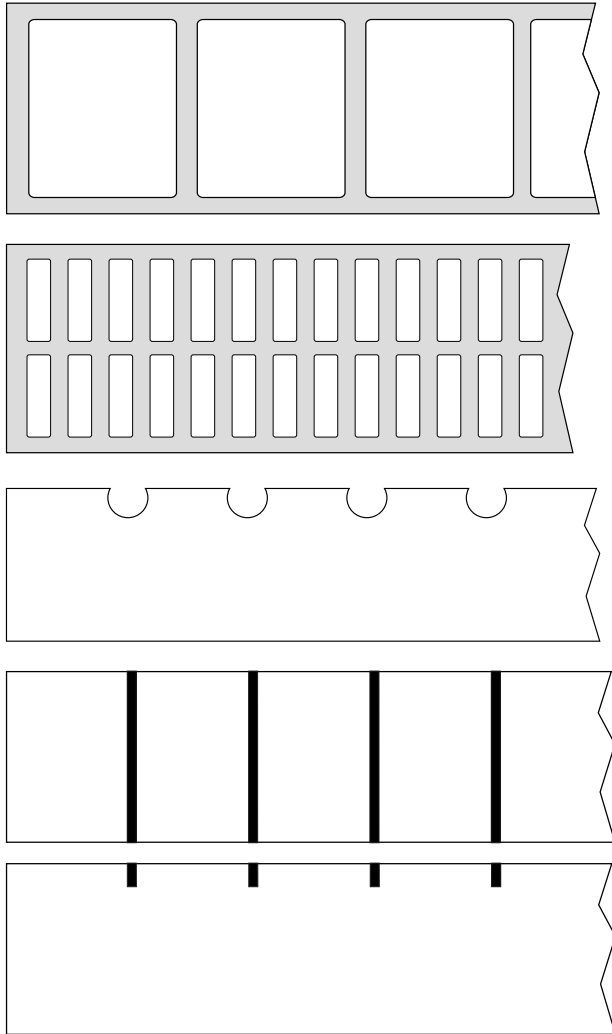

2.4 Media types

Your printer supports various media types, including non-continuous media, continuous media, and fanfold media. The following table provides details about them.

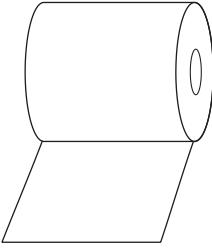
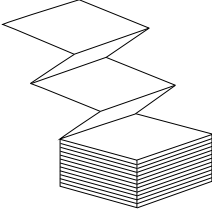
Media Type	Looks Like	Description
<p>Non-Continuous Media</p>		<p>Non-continuous media is the typical media for bar code printing. Labels and tags are made of various materials, such as paper, fabric or cardstock, and are separated by gaps, holes, notches or black marks. Many labels are self-adhesive with liners, while some are linerless.</p> 

Media Type	Looks Like	Description
Continuous Media		<p>Continuous media does not have gaps, holes, notches or black marks. It allows you to print data anywhere on the media. A cutter may be used for splitting labels.</p>
Fanfold Media		<p>Fanfold media is in continuous form, but it can be used as non-continuous media, because its labels are separated by folds. Some fanfold media also has black marks or liners.</p>
Tag Media		<p>Tag media is usually made from a heavy paper, with central hole to index. It does not have adhesive or a liner, and it is typically perforated between tags. The media may also have black marks or other separations</p>

2.5 Media sensing

WS2 printer offers reflective sensor. It used for detecting specific media types.

2.5.1 Transmissive sensor

The transmissive sensor is fixed and placed near the center line with 6.27 mm offset of the printhead. It is used for detecting gaps across the entire width of the label.

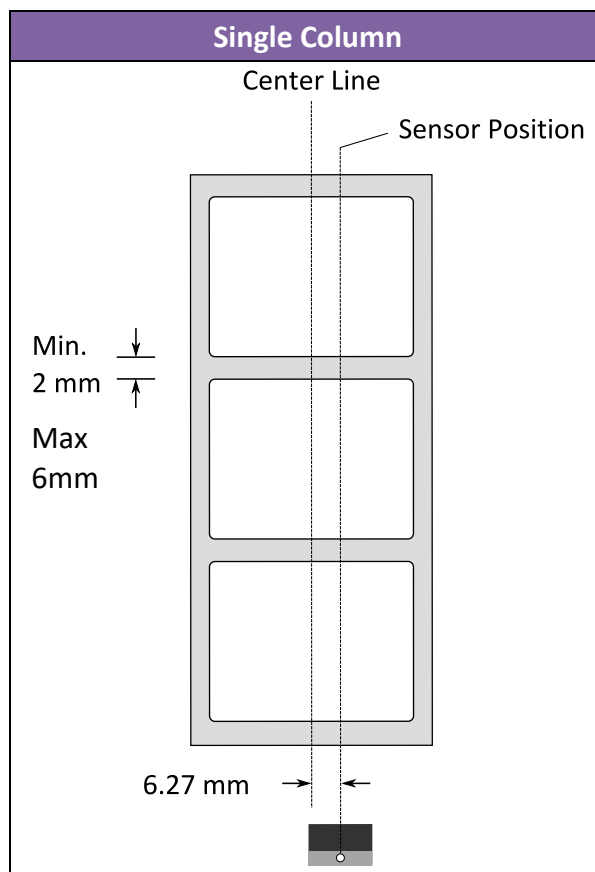

2.5.2 Reflective sensor

The reflective sensor is movable within the entire width of the media. It detects gaps, notches and black marks not located at the center of the media.

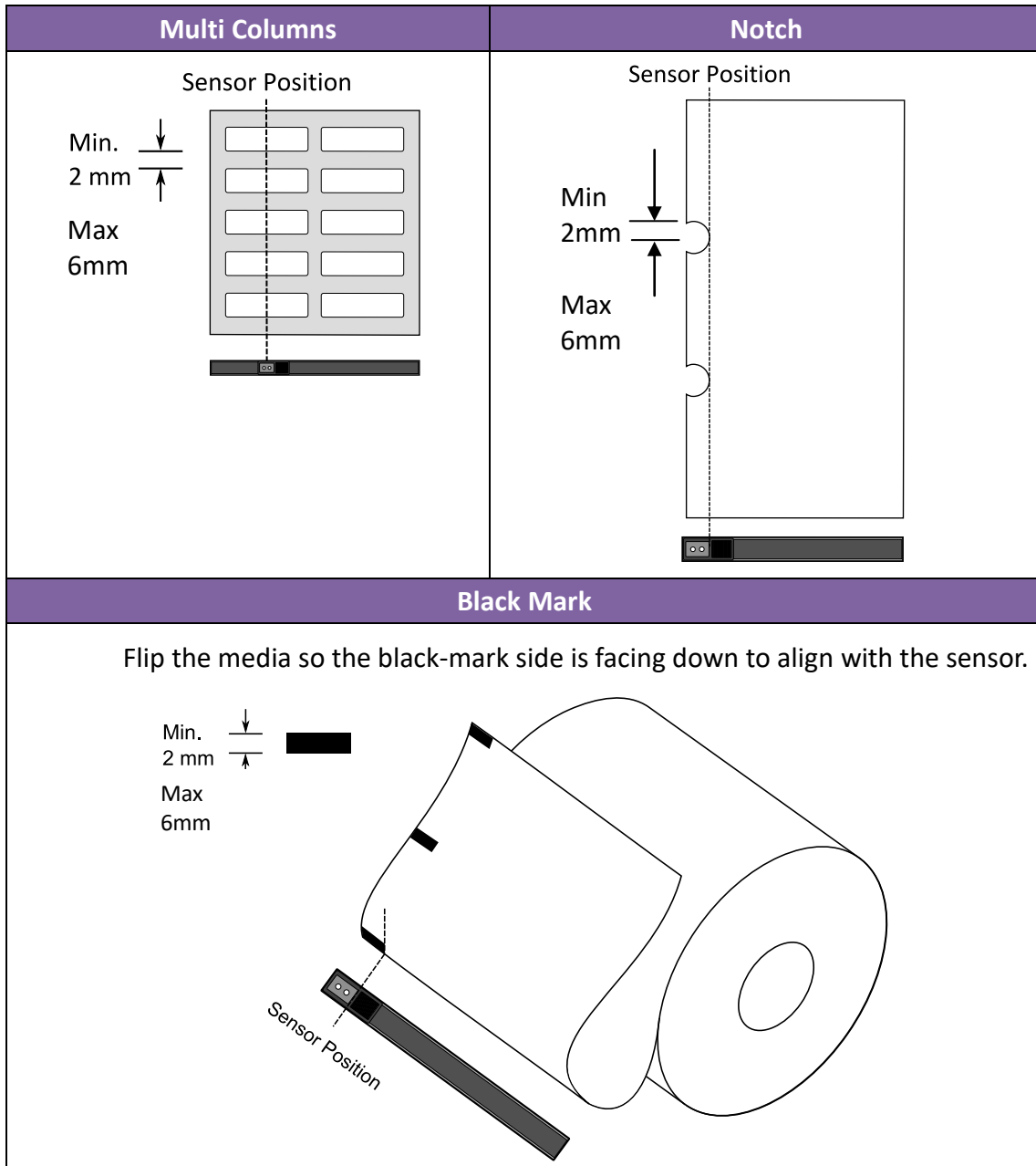

3 Printer operation

This chapter provides information about printer operation.

3.1 Printing Media Calibration & Configuration

You need to calibrate the media sensor to print properly. WS printers provide transmissive and reflective sensor calibration. Take the following steps to use them.

Doing calibration directly

1. Make sure the media is properly loaded, the print module is closed
2. Press and hold "FEED" button 3 seconds until LED2 turns to orange and LED1 turns to green. Media calibration start. Release "FEED" key

Go to System mode doing calibration

1. Make sure the media is properly loaded, the print module is closed
2. Set the power switch to the **OFF** position.
3. Press and hold the **FEED** button, and turn on the printer.
4. Both status lights glow solid Orange for a few seconds. Next, they turn to green shortly, and then turn to other colors. Do one of the following to select the sensor:
 - If you want to calibrate the transmissive sensor, when LED 1 turns to green and LED 2 turns to red, release the **FEED** button immediately.
 - If you want to calibrate the reflective sensor, when LED 1 turns to green and LED 2 turns to orange, release the **FEED** button immediately.
5. Press the **FEED** button. The media calibration is complete after the printer feeds 3-4 labels and stops.

3.2 Self test

The printer can run a self test to print a configuration label, which helps you understand current settings of the printer.







1. Turn off the printer.
2. Press and hold the **FEED** button, and turn on the printer.
3. Both status lights glow solid Orange for a few seconds. Next, they turn to green shortly, and then turn to other colors. When LED 2 turns to green and LED 1 turns to Orange, release the **FEED** button.
4. Press the **FEED** button to print a configuration label.

Your configuration label should look like this:

3 Printer operation

SZPL

```

  LABEL PRINTER WITH FIRMWARE
1  WS212-V01.03 20171123SZPL
2  STANDARD RAM : 32M BYTES
3  AVAILABLE RAM : 3684K BYTES
4  FLASH TYPE :
   ON BOARD 16M BYTES
5  AVAILABLE FLASH :
   8438K BYTES
6  NO. OF DL SOFT FONTS(FLASH):0
7  NO. OF DL SOFT FONTS(RAM) :0
8  NO. OF DL SOFT FONTS(HOST) :0
9  H. POSITION ADJUST.: 0011
10 SEE-THRU SENSOR
11 REF: 0000 SEE: 0000
12 RTC TIME: 1/1/0(0:38:24)
13 MAX LABEL HEIGHT: 50 INCHES
14 PRINT WIDTH: 638 DOTS
15 LAB LEN(TOP TO TOP): 10mm
16 SPEED: 3 IPS
17 ABS. DARKNESS: 16
18 TRIM. DARKNESS: 0
19 DIRECT THERMAL
20 PRINT LENGTH: 1M
21 CUT COUNT:0
22 CARET CONTROL CHAR : <^>5EH
23 DELIMITER CONTROL CHAR : <.>2CH
24 TILDE CONTROL CHAR : <~>7EH
25 CODE PAGE : USA1
26 MEDIA : CONTINUOUS
27 CALIBRATION MODE: INTELLI
28 REPRINT AFTER ERROR : ENABLED
29 BACKFEED DISABLED
30 CUTTER DISABLED
31 PEELER DISABLED
32 CUTTER/PEELER OFFSET:
   0 <+-0.01mm>
   LAN MODULE NOT INSTALL
33 IP ADDRESS: 0.0.0.0
34 SUBNET MASK: 0.0.0.0
35 GATEWAY: 0.0.0.0
36 MAC ADDRESS:
   AB-CD-EF-00-01-D2
37 DHCP: ENABLED
38 DHCP CLIENT ID:
   FFFFFFFFFFFFFFFF
   FFFFFFFFFFFFFFFF
39 DHCP HOST NAME:
40 SNMP: ENABLED
41 SOCKET COMM.: ENABLED
42 SOCKET PORT: 9100
43 IPV6 MODE: MANUAL
44 IPV6 TYPE: NONE
45 IPV6 ADDRESS:
   0000:0000:0000:0000
   0000:0000:0000:0000
46 LINK LOCAL :
   0000:0000:0000:0000
   0000:0000:0000:0000
47 PRODUCT SN: 0000000001
48 USB SN: 0000000001
49 CG ENABLED
50 ot(0.0)<0.1dot.0.01mm>
54 rm(0.0)<1+ 0-.0 01mm>
52 sm(0.0)<1+ 0-.0 01mm>
53 rv(0.0,0)<0.01v><F>
54 sv(0.0,0)<0.01v><F>
55 rso(0)<0.01mm>
56 sso(0)<0.01mm>
57 rago(0)<0.01v><F>
58 sagc(0)<0.01v><F>
59 sw: - - 0 0 0 -
      1 2 3 4 5 6
60 font a. 0123ABCabc
61 FONT B. 01230BCabc
62 FONT C. 0123ABCabc
63 FONT D. 0123ABCabc
64 FONT E. 0123ABCabc
65 FONT F. 0123ABCabc
66 FONT G.
67 FONT H. 0123ABC
68 Font CG 0123ABC
69 
70 
71 
72 
73 
74 
```

1. Version Information

The firmware version and its build date.

2. Standard RAM

Display SDRAM size.

3. Available RAM

RAM is able to be used.

4. Flash Type

The flash memory type and size.

5. Available Flash

Flash is able to be used.

6. No of DL soft fonts (FLASH)

The number of fonts is downloaded in Flash.

7. No of DL soft fonts (RAM)

The number of fonts is downloaded in RAM.

8. No of DL soft fonts (HOST)

The number of fonts is downloaded in USB HOST.

9. H. Position Adjust

Move the print position horizontally.

10. Sensor Type

Two kinds of media sensor type, reflective sensor and see-through sensor.

11. Label-less Calibration Value

Check if a label-less calibration has been performed on the printer. If not, the value is 0000.

12. RTC Time

The default format is month/day/year (hour:minute:second). If your printer has a built-in RTC, the RTC time shows here.

13. Max Label Height

The max label length you can print at a time. For 200 dpi models, it is 100 inches; for 300 dpi models, it is 50 inches.

14. Print Width

Display the print width in dots.

15. Lab Len (Top to Top)

For non-continues media, it is the length between the tops of two labels.

16. Speed

Printing speed unit is inch per second (ips).

17. ABS. Darkness

Display the current darkness. You can use the SZPL command `~SD` to define it.

18. Trim. Darkness

Display the adjustment of the current darkness. You can use the SZPL command `^MD` to define it.

19. Print Method

It is either thermal transfer (TT) or direct thermal (DT) printing. TT requires ribbons and DT doesn't.

20. Print Length

Display total print length.

21. Cut Count

It counts the times the cutter cuts.

22. Caret Control Char

The control character your printer is using.

23. Delimiter Control Char

The control character your printer is using.

24. Tilde Control Char

The control character your printer is using.

25. Code page

The character set table.

26. Media

The media type in use.

27. Calibration mode

Intelli Mode: Just install labels, latch print module, press FEED button once, and then the printer will feed 1-2 labels to detect next gap / black mark before printing. The printer will feed 1-2 labels automatically before printing, if FEED button is not pressed.

28. Reprint After Error

When it is enabled, your printer reprints the label after the error fixed if it is printed incorrectly due to the error.

29. Backfeed Enabled/Disabled

Enable or disable backfeed during the printing process. When it is enabled, the printer moves the paper forward in a predefined length 1 second after printing, and pulls the paper back in a predefined length once the printing begins again. When it is disabled, the printer won't move the paper at all.

30. Cutter Enabled/Disabled

Enable or disable the cutter during the printing process.

31. Peeler Enabled/Disabled

Enable or disable the dispenser during the printing process.

32. Cutter/Peeler Offset

Move the cutting line or the peeling position forward or backward. The value in the angle brackets is the offset unit.

33. IP Address

Display printer current IP address in. The default value is "192.168.1.1".

34. Subnet Mask

Display printer subnet mask. The default value is "255.255.255.0."

35. Gateway

Display printer gateway. The default value is "0.0.0.0."

36. MAC Address

The unique address assigned to the printer that connects to the internet.

37. DHCP

When DHCP is enabled, it assigns a dynamic IP address to the printer automatically.

38. DHCP Client ID

It is an arbitrary value sent to the DHCP server to reserve an IP address for the printer.

39. DHCP Host Name

It is the name of a DHCP client. The host name allows up to 32 alphanumeric characters.

40. SNMP

When it is enabled, the host gets or sets parameters registered as SNMP entities.

41. Socket Communication

When it is enabled, the host communicates with the printer via the socket.

42. Socket Port

Display printer port number.

43. IPv6 Mode

It determines how you get the IPv6 address of your printer. There are three modes: MANUAL, DHCPv6 or AUTO.

44. IPv6 Type

It is the IPv6 address type of your printer. There are four types: NONE, NORMAL, EUI and ANY.

45. IPv6 Address

Display printer current IPv6 address.

46. Link Local

The IPv6 address that used in a network segment. It is allocated automatically.

47. Product SN

Display printer serial number.

48. USB SN

Display printer USB host serial number.

49. CG Enable

Printer is able to use True Type font.

50. TPH and Cutter Offset

This is for developers to debug.

51. Reflective Sensor Gap Calibration

This is for developers to debug.

52. See-Through Sensor Gap Calibration

This is for developers to debug.

53. Reflective Sensor Profile

This is for developers to debug.

54. See-Through Sensor Profile

This is for developers to debug.

55. Ribbon Voltage Delta

This is for developers to debug.

56. Reflective Sensor Offset

This is for developers to debug.

57. See-Through Sensor Offset

3 Printer operation

This is for developers to debug.

58. See-Through Sensor Automatic Gain Control

This is for developers to debug.

59. SW

Display status of the dip switch.

60-68. Font Image

You can use them as the reference to check your label font.

69-74. TPH Test Pattern

You can use them to check broken pins on the printhead.

Option Parts

If your printer has a Wi-Fi module, your SZPL configuration label will contain the following entries:

FW Version

Display WLAN board firmware version.

Date

Display WLAN board firmware version date.

IP Address

Display the IP address of your printer. When DHCP is enabled, it shows the automatically assigned IP address; when DHCP is disabled, it shows the manually specified IP address.

Subnet mask

Display the current IPv4 subnet mask of your printer in Wi-Fi module.

Gateway

Display the gateway of your printer. When DHCP is enabled, it shows the automatically assigned gateway; when DHCP is disabled, it shows the manually specified gateway.

Mac address

The unique address assigned to your printer that connects to the internet.

DHCP

When DHCP is enabled, it assigns an IP address to your printer automatically.

DHCP Hostname

Display the name of a DHCP client in Wi-Fi module.

Socket Port

Display the socket number of the printer in Wi-Fi module.

SSID

Short for service set identifier. It is the name of a wireless local area network.

Mode

There are ad-hoc and infrastructure mode. Refer to Print Tool Network type description from Technical manual.

Country Code

3 Printer operation

Display the country or region in Wi-Fi module.

Channel

Display the Wi-Fi channel.

Network Authentication

There are six modes. Refer to Printer Tool Network authentication description from Technical manual.

WEP

Display the printer WEP encryption is on or off.

3 Printer operation

SDPL

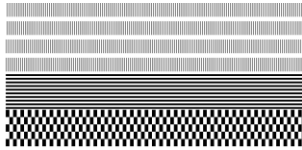

Smooth font(18)

Smooth font(14)

Smooth font(12 points)

Smooth font(1 points) - 12345

Smooth font(8 points) - 123456789 AB

Smooth font(6 points) - 123456789 ABCabcXyz

123456789

font7. 0CR-A ABCabc

FONT

FONT5. 012345678

FONT4. 012345678

FONT3. 0123456789 ABCABC

font2. 0123456789 ABCabcXyz

font1. 0123456789 ABCabcXyz

font8. 0123456789 ABCabcXyz

```
1 2 3 4 5 6
su: - - 0 0 0 -
sasc(0)<0.01u><F>
rasc(0)<0.01u><F>
sso(0)<0.01mm>
rso(0)<0.01mm>
sv(0.0.0)<0.01u><F>
rv(0.0.0)<0.01u><F>
sm(0.0)<1+ 0-.0.01mm>
rm(0.0)<1+ 0-.0.01mm>
ot(0.0)<0.1dot.0.01mm>
CG ENABLED
USB SN: 000000000001
PRODUCT SN: 000000000001
0000-0000:0000-0000
0000-0000:0000-0000
LINK LOCAL :
0000-0000:0000-0000
0000-0000:0000-0000
IPUG ADDRESS:
IPUG TYPE: NONE
IPUG MODE: MANUAL
SOCKET PORT: 9100
SOCKET COMM.: ENABLED
SNMP: ENABLED
DHCP HOST NAME:
FFFFFFFFFFFFFFFF
FFFFFFFFFFFFFFFF
DHCP CLIENT ID:
DHCP: ENABLED
AB-CD-EF-00-01-02
MAC ADDRESS:
GATEWAY: 0.0.0.0
SUBNET MASK: 0.0.0.0
IP ADDRESS: 0.0.0.0
LAN MODULE NOT INSTALL
0 <+-0.01mm>
CUTTER/PEELER OFFSET:
PEELER DISABLED
CUTTER DISABLED
BACKFEED DISABLED
CALIBRATION MODE: INTELLI
MEDIA : CONTINUOUS
STD CTRL CODES
CODE PAGE : PC-850
CUT COUNT: 0
PRINT LENGTH: 1M
DIRECT THERMAL
DARKNESS: 10
SPEED: 3 IPS
LAB LEN(TOP TO TOP): 10mm
PRINT WIDTH: 1184 DOTS
MAX LABEL HEIGHT: 50 INCHES
RTC TIME: 1/1/0(0:56:48)
REF: 0000 SEC: 0000
SEE-THRU SENSOR
H. POSITION ADJUST.: 0011
NO. OF DL SOFT FONTS(HOST) : 0
NO. OF DL SOFT FONTS(RAM) : 0
NO. OF DL SOFT FONTS(FLASH) : 0
8438K BYTES
AVAILABLE FLASH :
ON BOARD 16M BYTES
FLASH TYPE :
AVAILABLE RAM : 3684K BYTES
STANDARD RAM : 32M BYTES
US212-U01.03 20171123SDPL
LABEL PRINTER WITH FIRMWARE
```

3 Printer operation

SEPL

```
LABEL PRINTER WITH FIRMWARE
WS212-V01.03 20171123SEPL
STANDARD RAM : 32M BYTES
AVAILABLE RAM : 3684K BYTES
FLASH TYPE :
ON BOARD 16M BYTES
AVAILABLE FLASH :
8438K BYTES
NO.OF DL SOFT FONTS(FLASH):0
NO.OF DL SOFT FONTS(RAM) :0
NO.OF DL SOFT FONTS(HOST) :0
H. POSITION ADJUST.: 0011
SEE-THRU SENSOR
REF: 0000 SEE: 0000
RTC TIME: 1/1/0(0:18:46)
MAX LABEL HEIGHT: 50 INCHES
PRINT WIDTH: 638 DOTS
LAB LEN(TOP TO TOP): 10mm
SPEED: 3 IPS
DARKNESS: 8
DIRECT THERMAL
PRINT LENGTH: 1M
CUT COUNT:0
CODE PAGE : English (437)
MEDIA : CONTINUOUS
CALIBRATION MODE:INTELLI
BACKFEED DISABLED
CUTTER DISABLED
PEELER DISABLED
CUTTER/PEELER OFFSET:
0 <+-0.01mm>
LAN MODULE NOT INSTALL
IP ADDRESS: 0.0.0.0
SUBNET MASK: 0.0.0.0
GATEWAY: 0.0.0.0
MAC ADDRESS:
AB-CD-EF-00-01-D2
DHCP: ENABLED
DHCP CLIENT ID:
FFFFFFFFFFFFFFFF
FFFFFFFFFFFFFFFF
DHCP HOST NAME:
SNMP: ENABLED
SOCKET COMM.: ENABLED
SOCKET PORT: 9100
IPV6 MODE: MANUAL
IPV6 TYPE: NONE
IPV6 ADDRESS:
0000:0000:0000:0000
0000:0000:0000:0000
LINK LOCAL :
0000:0000:0000:0000
0000:0000:0000:0000
PRODUCT SN: 00000000001
USB SN: 000000000001
CG ENABLED
ot(0,0)<0.1dot,0.01mm>
rm(0,0)<1+ 0-,0.01mm>
sm(0,0)<1+ 0-,0.01mm>
rv(0,0,0)<0.01v><F>
sv(0,0,0)<0.01v><F>
rso(0)<0.01mm>
sso(0)<0.01mm>
ragc(0)<0.01v><F>
sagc(0)<0.01v><F>
sw: - - 0 0 0 -
    1 2 3 4 5 6
font 1. 0123456789 ABCabcxyz
font 2. 0123456789 ABCabcXyz
font 3. 0123456789 ABCabcXy
font 4. 0123456789 ABCXY
```

FONT 5

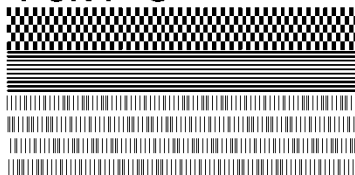

3.3 Reset your printer

By resetting your printer, you can return your printer to the state it was in when you receive it. This can help you solve some problems caused by settings changed during the printing.

Do the following to reset your printer:

1. Turn off the printer.
2. Press and hold the **FEED** button, and turn on the printer.
3. Both status lights glow solid Orange for a few seconds. Next, they turn to green shortly, and then turn to other colors. When both lights turn to red, release the **FEED** button immediately.
4. Press and hold the **FEED** button over 3 seconds and release it. Both status lights blink red three times, and turn to solid Orange for a few seconds. After the printer is reset, LED 1 goes out while LED 2 turns to solid green.



Important In step 4, if you do not hold the **FEED** button long enough, LED 1 will blink Orange three times while LED 2 goes out. It means the printer is not reset.

3.4 Communications

3.4.1 Interfaces and Requirements

This printer comes with USB type A and type B interface, an ethernet.

■ USB Interface Requirements

The Universal Serial Bus (USB) interface is compatible with your existing PC hardware. The USB’s “plug and play” design makes installation easy. Multiple printers can share a single USB port/hub. The different usage of type A and B are as below.

USB type A	USB Flash drive, USB keyboard or USB Scanner.
USB type B	PC to set printer.

■ Ethernet Module Status Indicators

The indicators with two different colors help users understand status of Ethernet:

LED Status	Description	
Both Off	No Ethernet link detected.	
Blinking	The printer waits for printer ready. It will take about few seconds to be ready.	
Green	Speed LED	On: 100 Mbps link Off: 10 Mbps link
Orange	Link/Activity LED	On: link up Off: link down Blinking: activity

4 Maintenance

This chapter describes routine cleaning procedure.

4.1 Cleaning

To maintain print quality and prolong the printer's life, you need to perform some routine maintenance. Daily maintenance should be done for high volume printing, and weekly for low volume printing.



Caution Always turn off the printer before cleaning.

4.1.1 Printhead

It is essential to keep printhead clean if you want the best print quality. We strongly recommend that you clean the printhead when you load a new media roll. If the printer is operated in critical environment, or the print quality declines, you need to clean the printhead more frequently.

Keep in mind these things before you clean:

- Keep the water away in case of corrosion on heating elements.
- If you just finish printing, wait until the printhead cools down.
- Do not touch the printhead with bare hands or hard objects.

Cleaning steps:

1. Moisten a soft cloth or a cotton swab with ethyl alcohol.
2. Gently wipe the printhead in one direction. That is, wipe it only from left to right or vice versa. Do not wipe back-and-forth, in case dust or dirt attaches to the printhead again.

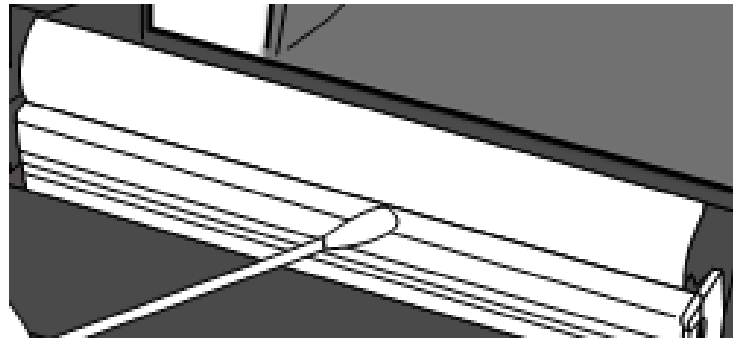

Note Printhead warranty becomes void if printhead serial number is removed, altered, defected, or made illegible, under every circumstance.

4.1.2 Media housing

Use a soft cloth to clean the dust, dirt or debris built up on the **Media Roll Holders, Media Guides** and media path.

1. Moisten a soft cloth with ethyl alcohol.
2. Wipe the **Media Roll Holders** to clean dust.
3. Wipe the **Media Guides** to clean dust and dirt.
4. Wipe the media path to clean paper debris.

4.1.3 Sensor

Media sensors may not be able to detect the media correctly if it becomes dirty.

1. Moisten a soft cloth or a cotton swab with absolute ethyl alcohol.
2. Gently brush sensors to remove the dust away.
3. Use a dry cloth to clean the residue.

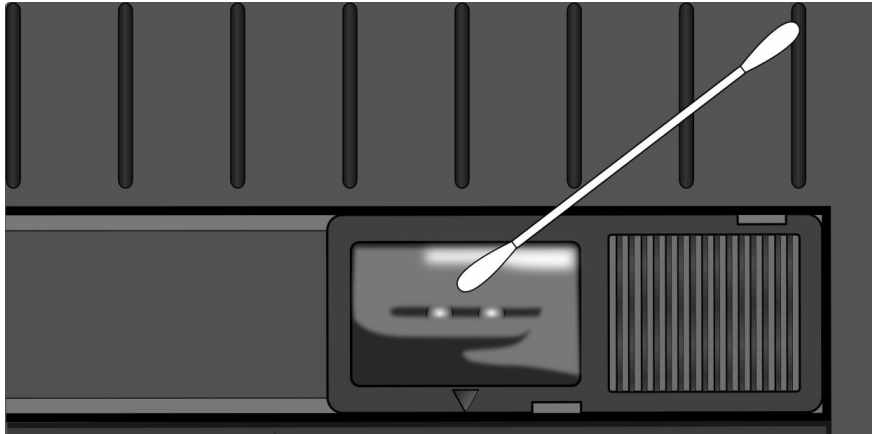

4.1.4 Platen roller

The platen roller is also important for print quality. Dirty platen roller may damage the printhead. Clean the platen roller right away if the adhesive, dirt or dust accumulates on it.

1. Moisten a soft cloth with absolute ethyl alcohol.
2. Gently wipe the platen roller to remove the dust and adhesive.

5 Troubleshooting

This chapter provides the information about printer problems and solutions.

5.1 Printer issues

The printer is not turned on

- Did you attach the AC power cord?
- Make sure the power supply's connector is inserted into the printer power jack.
- Check the power connection from the wall socket to the printer. Test the power cord and the socket with other electrical devices.
- Disconnect the printer from the wall socket, and connect it again.

The printer turns itself off

- Turn on the printer again.
- Make sure the power supply's connector and the power cord are plugged properly.
- Make sure the power supply and the power cord are not damaged.
- Use the applicable power supply.
- If the printer keeps turning itself off, check the socket and make sure it has enough power for the printer.

The printer does not feed the media out

- The media is not loaded correctly. See Section 2.3, "Loading Media" to reload the media.
- If there is a paper jam, clear it.

5.2 Media issues

The media is out

- Load a new media roll.

The paper is jammed

- Open the printer and clear the jammed paper.
- Make sure the paper is held properly by the **Media Guides**.

The printing position is not correct

- Did you use the correct media type for printing?
- The media is not loaded correctly. See Section 2.3, “Loading Media” to reload the media.
- The media sensor needs to be calibrated. See Section 3.1, “Media Sensor Calibration” to calibrate the sensor.
- The media sensor is dirty. Clean the media sensor.

Nothing is printed

- The media is not loaded correctly. See Section 2.3, “Loading Media” to reload the media.
- The print data might not be sent successfully. Make sure the interface is set correctly in the printer driver, and send the print data again.

The print quality is poor

- The printhead is dirty. Clean the printhead.
- The platen roller is dirty. Clean the platen roller.
- Adjust the print darkness, or lower the print speed.
- The media is incompatible for Direct Thermal. Use the compatible media instead.
- The media is incompatible for the printer.

5.3 Other issues

There are broken lines in the printed label

- The printhead is dirty. Clean the printhead.

An error occurred when writing data to the USB memory

- Did you insert the USB drive?
- Make sure the USB drive is plugged tightly into the port.
- The USB drive might be broken. Replace it with another one.

The printer is unable to save files due to insufficient USB memory

- Delete the files on your USB drive to free some space, or replace your USB drive with an empty one.

The cutter is experiencing issues

- If there is a paper jam, clear it.
- The cutter has become loose. Fix the cutter in position and tighten it.
- The cutter blade is not sharp anymore. Replace your cutter with a new one.

The printhead temperature is extremely high

- The printhead temperature is controlled by the printer. If it is extremely high, the printer will stop printing automatically, until the printhead is cool down. After that, the printer will resume printing automatically, if there is any unfinished print job.

The printhead is broken

- Contact your local dealer for assistance.

6 Set Up Interface Connection by SATO WS2 Printer Utility

SATO WS2 Printer Utility provides a user-friendly interface to configure your printer. You can define properties, update firmware and send commands in SATO WS2 Printer Utility.

6.1 Install SATO WS2 Printer Utility

1. Insert the DVD into your DVD drive.
2. Locate the installation file on the DVD and click it.
3. In the **SATO WS2 Printer Utility** dialog box, click **Next**.

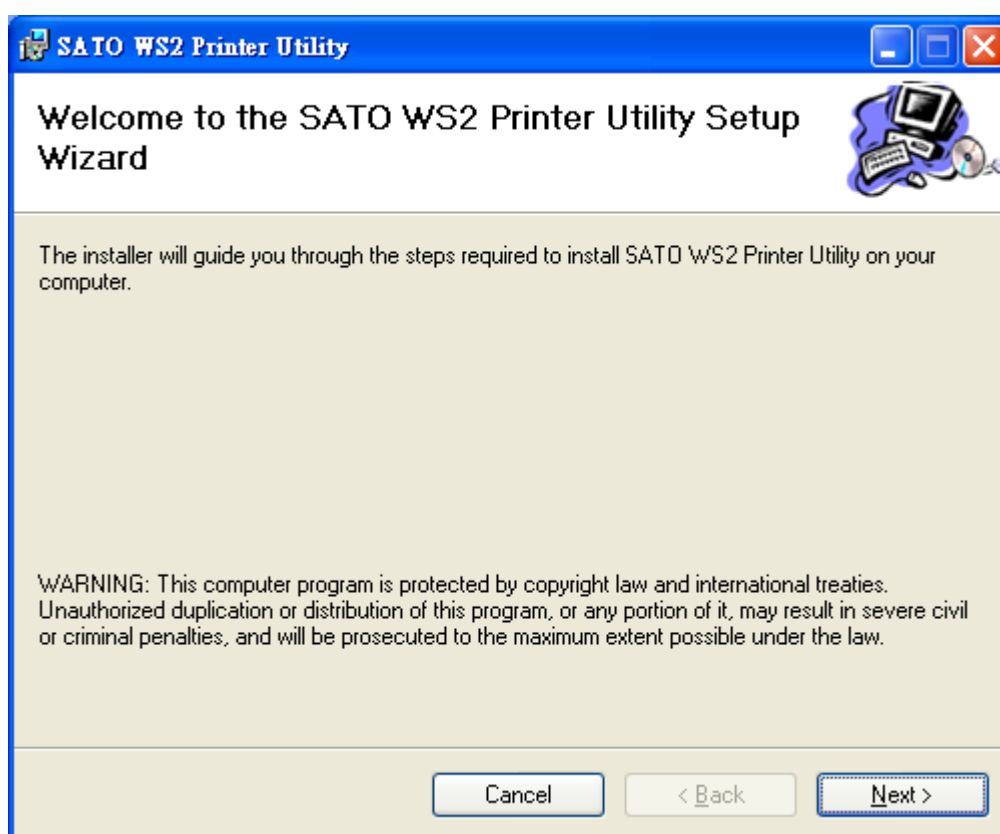

4. In this dialog box, follow the instructions to choose the installation path, and then click **Next**.

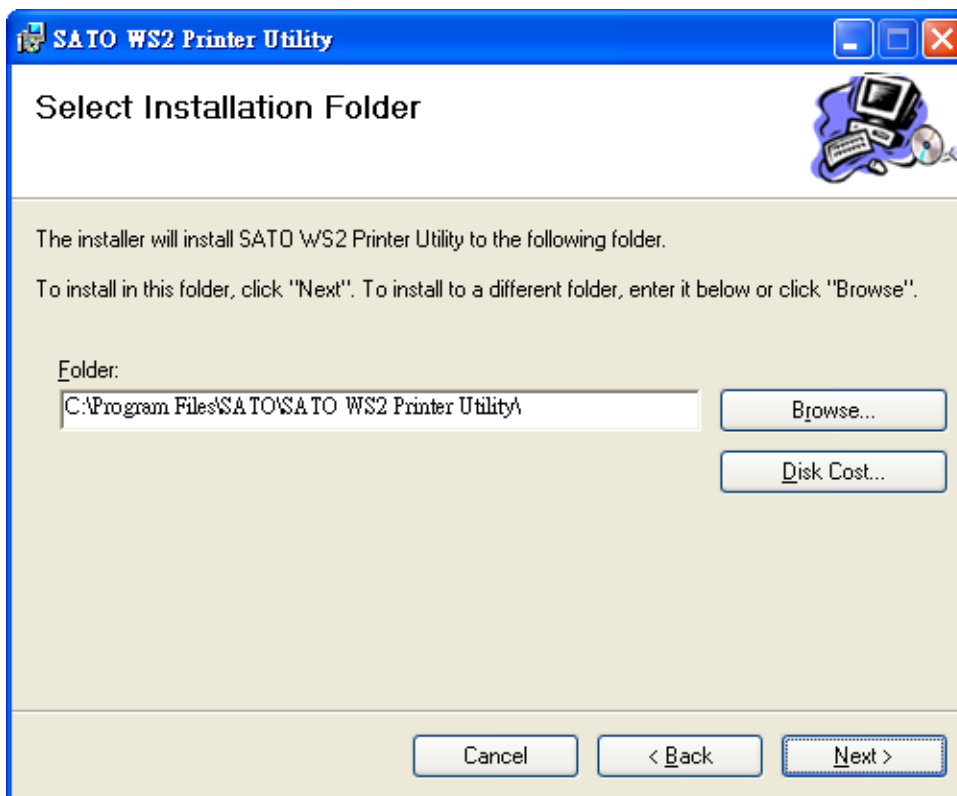

5. In this dialog box, click **Next**.

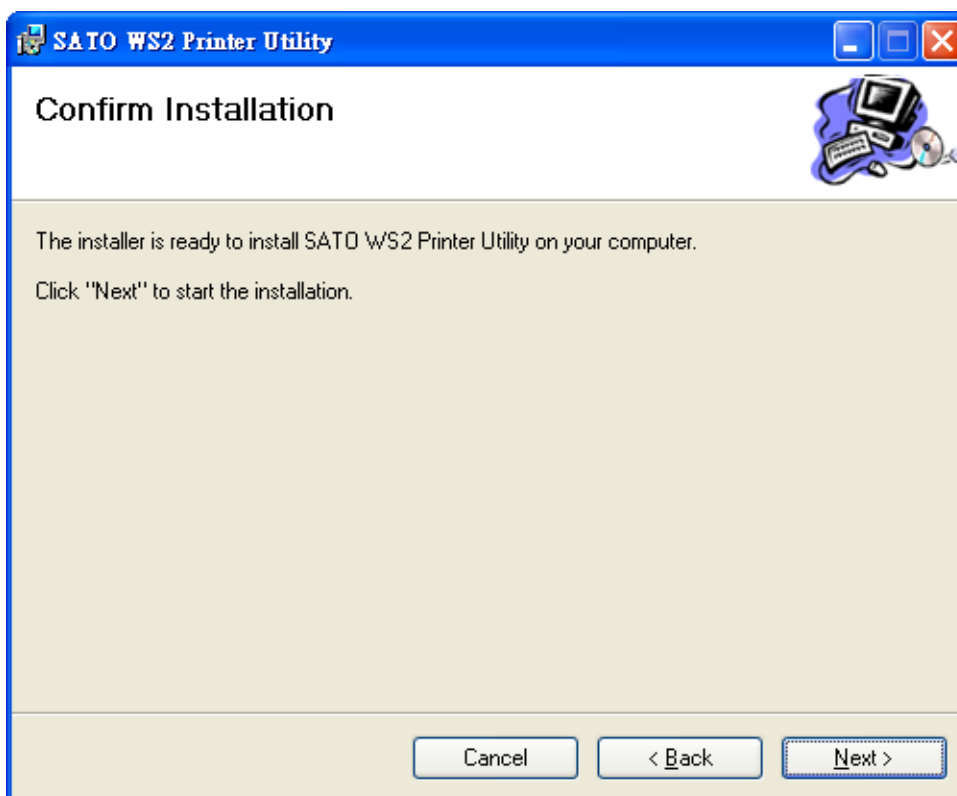

6. After the installation of SATO WS2 Printer Utility is complete, click **Close**.

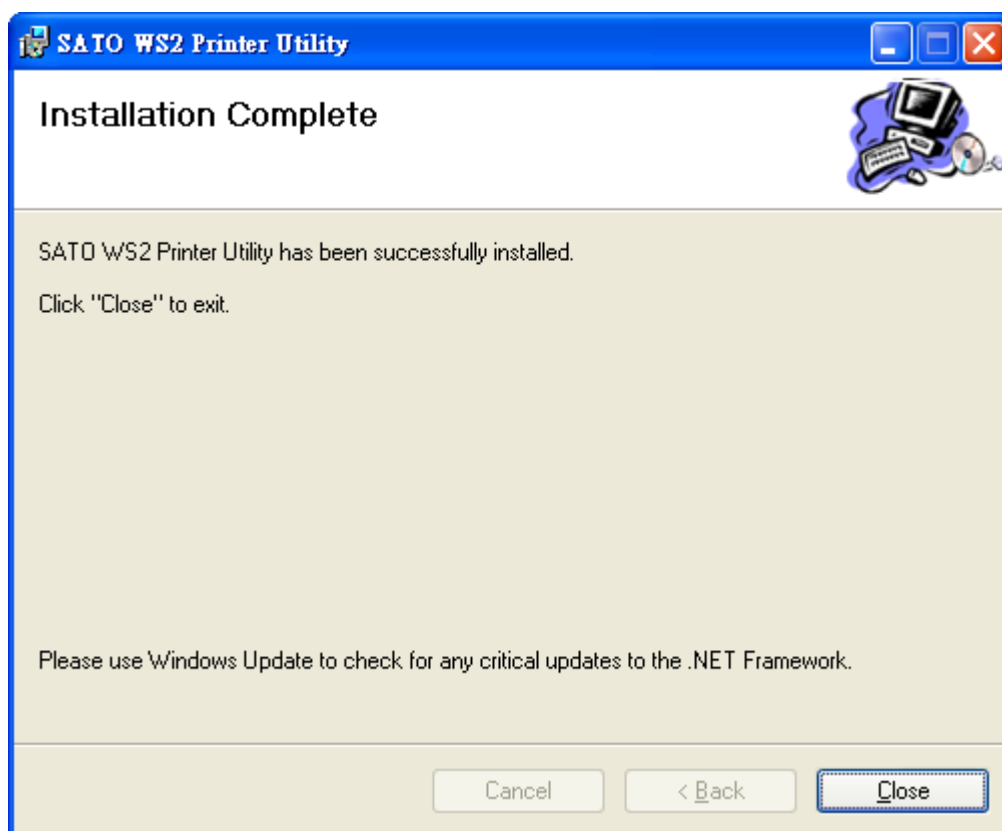

6.2 Work with SATO WS2 Printer Utility

Start SATO WS2 Printer Utility. Its interface looks like this:

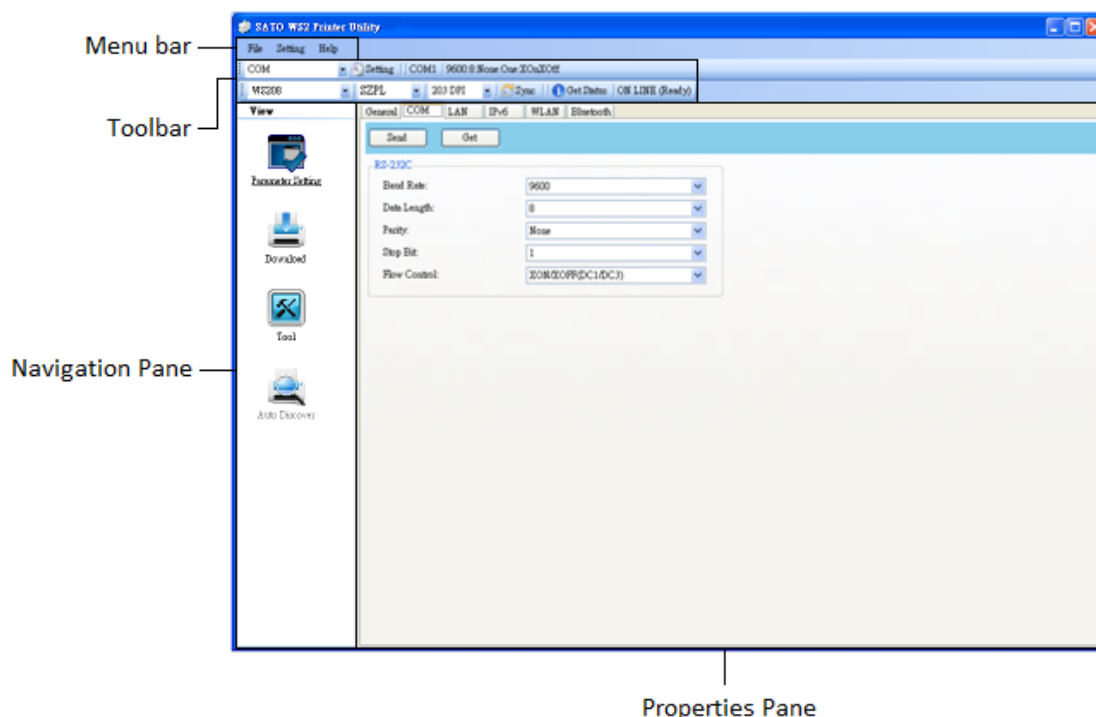

- **Menu bar** It includes SATO WS2 Printer Utility menus.
- **Toolbar** It provides ports, port settings, emulation languages, printer dpi and printer status.
- **Navigation Pane** You can switch between the listed items to view their tabs.
- **Properties Pane** You can view and manage printer properties or perform tasks.

6.2.1 Menu bar

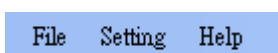

There are three menus in the menu bar: **File**, **Setting** and **Help**.

File

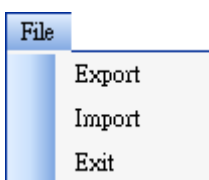

- **Export** Export your printer settings to an XML file, including all parameters, port settings and firmware information.
- **Import** Import printer settings from an XML file.
- **Exit** Exit SATO WS2 Printer Utility.

Setting

- **Auto Detect USB** When you connect your printer to a computer with a USB cable, SATO WS2 Printer Utility automatically detects it and shows the USB information in the **Port Name** and **Port Information**. By default, it is enabled.

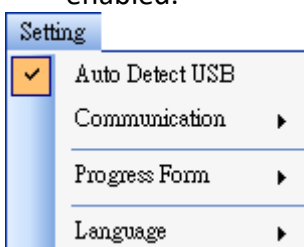

■ **Communication**

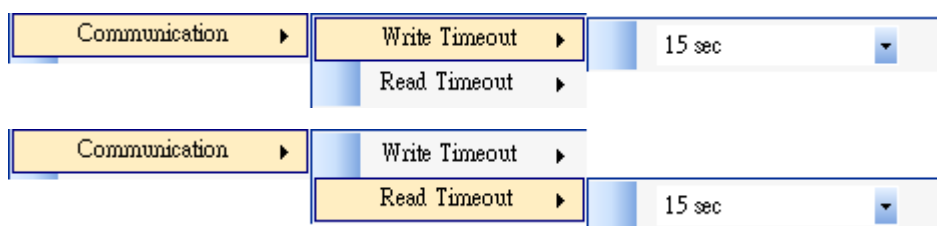

It includes **Write Timeout** and **Read Timeout**. They determine how long your computer (or other devices) waits printer's response when it attempts to write or read data to your printer. The default value is 15 seconds, meaning that the computer waits 15 seconds, and displays an error message if it doesn't receive any response.

■ **Progress Form**



When **Add Date/Time information** is enabled, the current date and time are added into the message in the **Download Firmware** dialog box.

■ **Language**

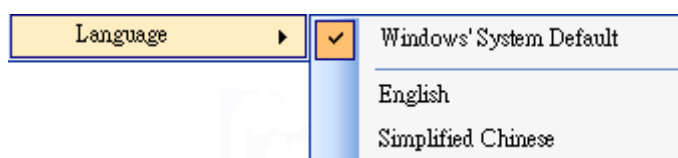

It is the language of SATO WS2 Printer Utility interface. You can select **Windows's System Default**, **English** or **Simplified Chinese**. By default, it uses your system default.

Help

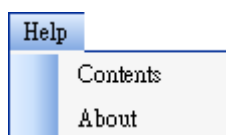

- **Contents** The help content of SATO WS2 Printer Utility. You can press F1 to display it.
- **About** The version and copyright information about SATO WS2 Printer Utility.

6.2.2 Toolbar

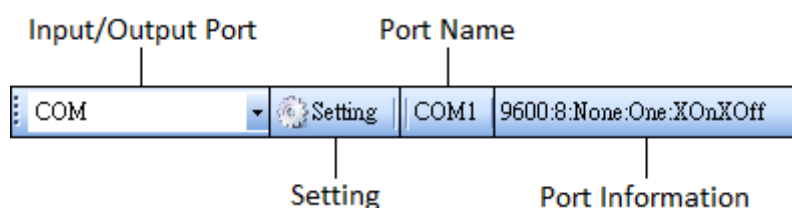

The toolbar has two rows. The first row includes three items.

- **Input/Output Port** The port you use for the data transmission between the computer and your printer.
- **Setting** You can click it to configure the port settings.
- **Port Name** It shows the port name.
- **Port Information** It shows the port information.

SATO WS2 Printer Utility provides three ports for data transmission.

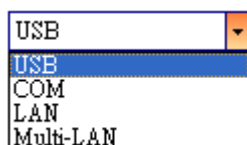

- **USB**

It shows the USB information in the **Port Name** and **Port Information** as soon as the computer detects your printer. By default, the computer automatically detects the **USB** port. You can select the printer you want if your computer is connected to multiple printers via USB. Click **Search** to search the hot-plugging USB printer.

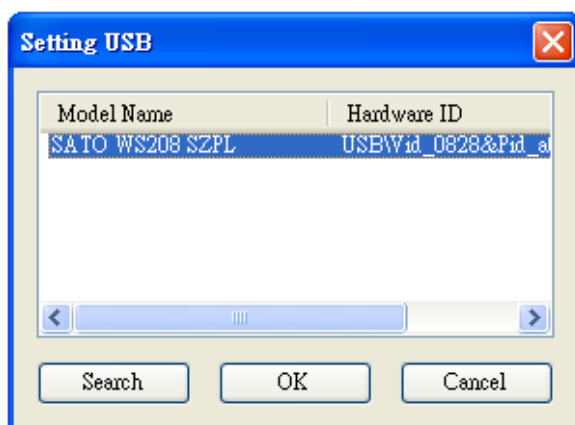

■ COM

It is the serial port and related to the **COM** tab in **Parameter Setting**. The settings of the **COM** port need to be the same as those in the **COM** tab, except for **Port Name**, which lets you select the **COM** port you want if your computer is connected to multiple printers via COM. If you want to reset all of COM settings, click **Default**.

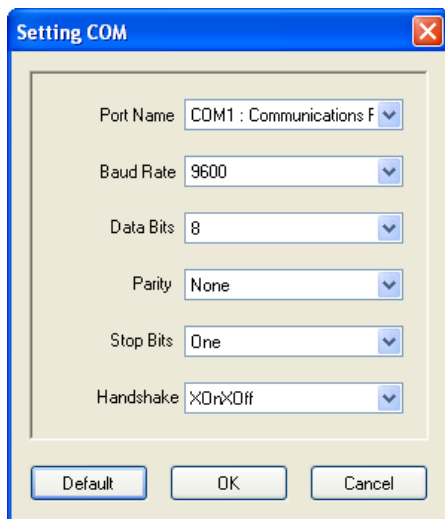

■ LAN

It is the Ethernet port and related to the **LAN** tab in **Parameter Setting**. It supports IPv4 and IPv6 addresses. For more information about setting up a network connection, see *Set up LAN connection*, *Set up IPv6 connection* and *Set up WLAN connection*.

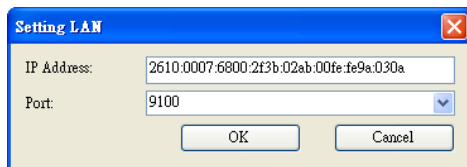
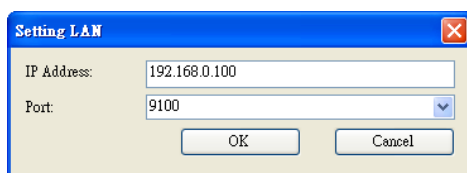

■ **Multi-LAN**

It allows you to perform tasks on network printers. For example, you can add other printers' IP addresses in Multi-LAN setting, and update firmware for all printers at once. If any error has occurred during the connection, Printer Tool skips that IP address and tries the next one. Before you use the **Multi-LAN** port, you need to set up a network connection. For further details, see *Set up LAN connection*, *Set up IPv6 connection* and *Set up WLAN connection*.

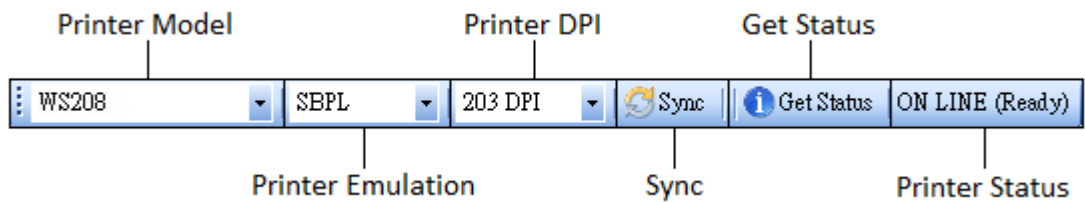
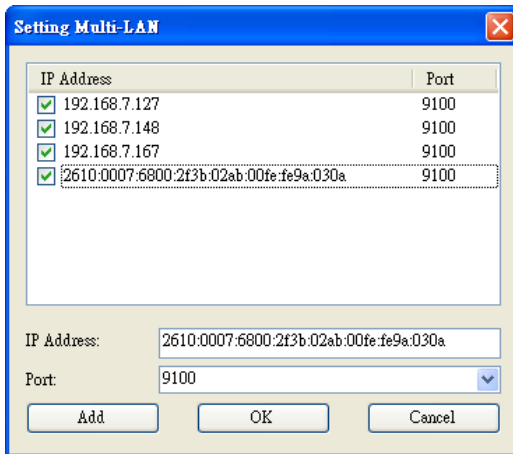

The second row of the toolbar includes six items.

- **Printer Model** Printer models.
- **Printer Emulation** The emulation language of your printer. The emulation you choose affects the tabs displayed in the **Properties** pane.
- **Printer DPI** The print resolution of your printer. It provides 203 dpi and 300 dpi.
- **Sync** Get the current settings of **Printer Model**, **Printer Emulation** and **Printer DPI** from your printer.
- **Get Status** Detect if your printer is ready for use.
- **Printer Status** It shows the result of **Get Status**.

Printer status

Status	Description
ON LINE (Ready)	The top cover (head) was closed in the online mode.
HEAD OPEN	The top cover (head) was opened in the online mode.
ON LINE (Operating)	The printer is operating.
ACCESSED BY OTHER	Exclusively accessed by other host.
PAUSE	In pause.
ON LINE (Waiting for Stripping)	Waiting for stripping.
COMMAND ERROR	A command error was found while analyzing the command.
COMMS ERROR	A parity error, overrun error or framing error occurred during the RS-232C transmission.
PAPER JAM	A paper jam occurred during paper feed.
CUTTER ERROR	The cutter is experiencing issues.
NO PAPER	The label has run out.
HEAD OPEN ERROR	Attempt to feed or issue the label with the top cover (head) open.
HEAD ERROR	A broken pin has been found on the thermal head.
EXCESS HEAD TEMP	The thermal head temperature has become excessively high.
NO PAPER (Last label has been issued)	The last label has been issued properly and the label has run out.
LOW BATTERY	RTC battery is low (future option).
MEMORY WRITE ERROR	An error has occurred while writing data into the flash ROM or USB memory.
FORMAT ERROR	An erase error has occurred in formatting the flash ROM or USB memory.
MEMORY FULL	Saving failed because of the insufficient capacity of the flash ROM or USB memory.
SAVING	In font or PC command save mode. (to flash ROM or to USB memory)
	The flash ROM or USB memory is being initialized.
SAVING ERROR	An EEPROM for backup cannot be read or written properly.
UPDATING FIRMWARE NOW	The printer is updating firmware.
BLUETOOTH ERROR	Bluetooth initialization error.

Status	Description
	Bluetooth setting parameter error.
WIRELESSLAN ERROR	WirelessLAN initialization error.
	WirelessLAN setting parameter error.
UPDATING FIRMWARE ERROR	An error occurred during the firmware update.
UNKNOWN	The status is unknown.

6.2.3 Navigation pane

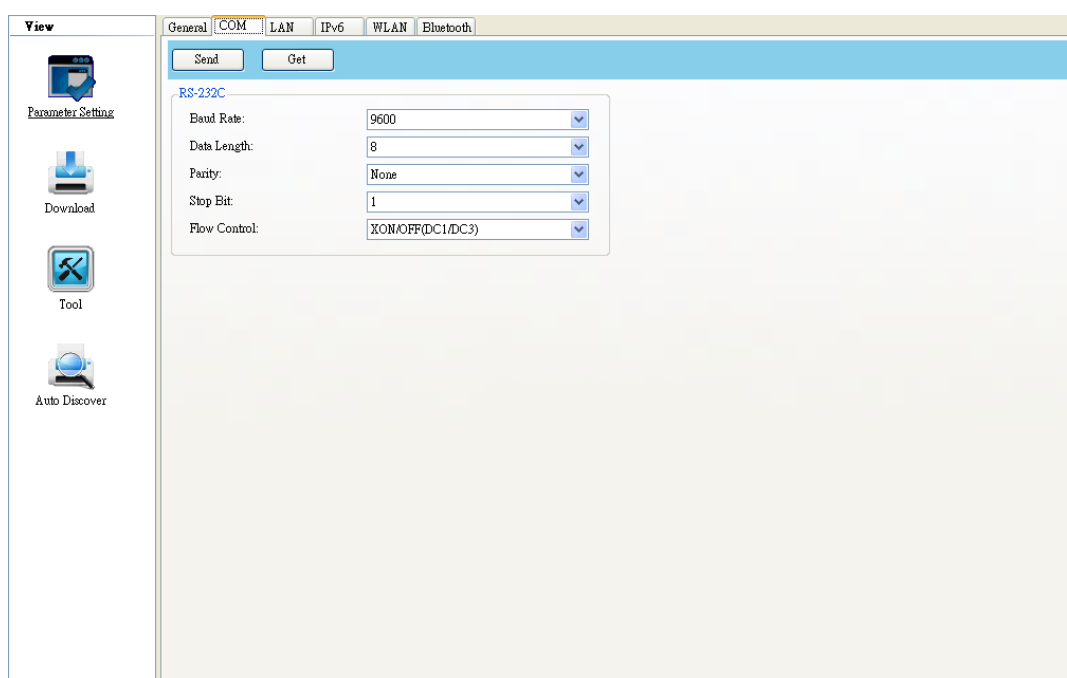

The **Navigation** pane includes four items: **Parameter Setting**, **Download**, **Tool** and **Auto Discover**. Each item has its own tabs, and each tab has a **Send**, **Get**, **Add** or **Delete** button (Some of them only have **Send**). **Send** is to send your settings to your printer; **Get** is to get the current settings of your printer; **Add** is to add file to the list object; **Delete** is to delete file from the list object. You can also right-click in the **Properties** pane and select **Send**, **Get**, **Add** or **Delete** in the shortcut menu. Each time you click **Send**, your printer restarts to apply the change.



Important You can send data via all ports, but can only get data via the **USB**, **COM** and **LAN** ports.

Parameter Setting

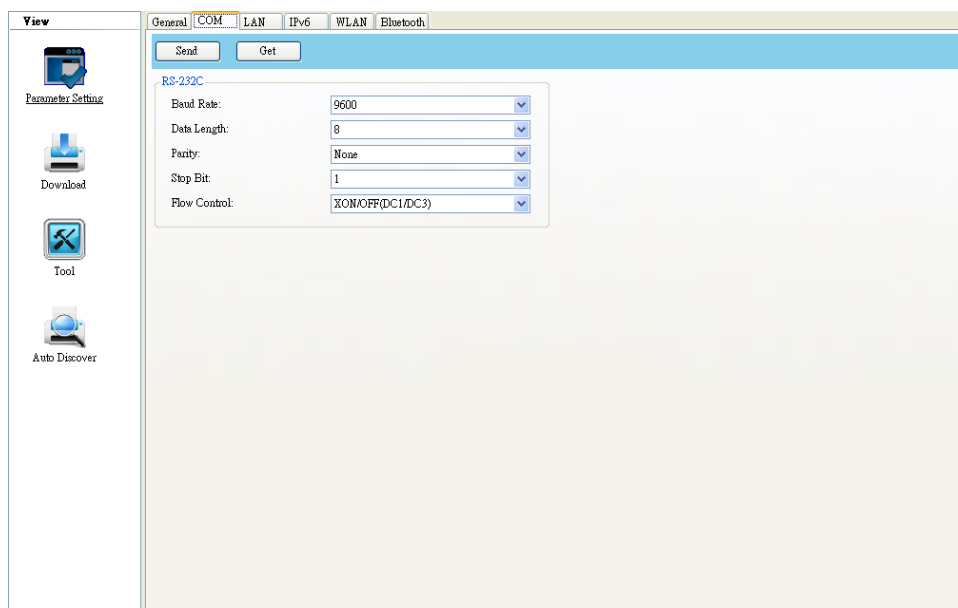

Parameter Setting is used to configure printer settings. It includes six tabs: **General, COM, LAN, IPv6, WLAN and Bluetooth.**

General

The **General** tab provides general printer settings. It is related to the emulation language you choose. Each language provides its own properties.

- SDPL, SEPL, SZPL and AUTO

SDPL, SEPL, SZPL and AUTO provides settings grouped in the **Supply, Control, Action, Label and Position Adjustment** area.

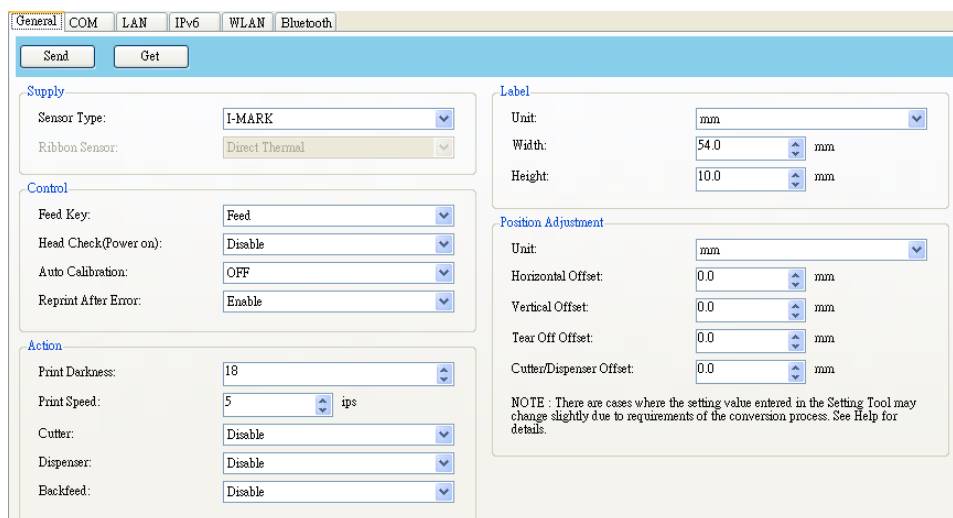

Property Name	Description
Sensor Type	It is the media sensor you are using. It includes I-MARK , GAP and None . When you perform media calibration, the sensor is set to the one you select.
Ribbon Sensor	Thermal Transfer Your printer uses the ribbon sensor to detect the ribbon, it is mean Thermal Transfer (TT) . Direct Thermal Disable the ribbon sensor, it is mean Direct Thermal (DT) .
Feed Key	It defines the action of the FEED button. Feed Your printer feeds a blank label each time the button is pressed. Reprint Your printer reprints the last label each time the button is pressed.
Head Check(Power on)	Enable Your printer checks broken pins on the printhead automatically once your printer is turned on. Disable Disable the auto head check.
Auto Calibration	ON (Power on) Your printer automatically calibrates media using a media sensor once it restarts or is turned on. ON (Head close) Your printer automatically calibrates media using a media sensor every time you close the print module when the printer is turned on. ON (Power on and Head close) Your printer automatically calibrates media using a media sensor after power on and every time you close the print module when the printer is turned on. OFF You need to manually calibrate media using a media sensor as you change the media, or your printer won't work properly.
Reprint After Error	Enable Your printer when caused by the error condition. The label is reprinted as soon as the error condition is corrected. Disable Disable the reprint after error.
Print Darkness	Adjust the darkness relative to the current darkness setting. The range is 0 ~ +30, and the value is adjustable in increments of ± 1 .
Print Speed	Determine the media speed during printing. The range is

Property Name	Description
	+2 ~ +6, and the value is adjustable in increments of ± 1 ips.
Cutter	Enable If the printer has a cutter module. The label will be cut after printing. Disable Disable the cutting action after printing.
Dispenser	Enable If the printer has a dispenser module. The label will be peel after printing. Once the label has been removed from dispenser, the printer will begin to print next label again. Disable Disable the paper detect before printing, then the printer will print without waiting.
Backfeed	Enable The printer will pull the paper backward into the printer so that the first printing position is on the predefined length behind thermal print head. Disable Disable the paper backfeed action when start printing.
Unit(Label)	mm Change the unit of label to millimeter. inch Change the unit of label to inch.
Width	Set the print width.
Height	Set the length of the label when using continuous media.
Unit(Position Adjustment)	mm Change the unit of Position Adjustment to millimeter. Inch Change the unit of Position Adjustment to inch. dots Change the unit of Position Adjustment to dots.
Horizontal Offset	Move the print position horizontally. The positive number is left, and the negative number is right.
Vertical Offset	Move the print position vertically. The positive number is forward, and the negative number is backward.
Tear Off Offset	Adjust the rest position of the media after a label is printed, which changes the position at which the label is torn or cut.
Cutter/Dispenser Offset	Adjust the cutter/dispenser offset position at which the label is peel or cut.

mm/inch/dot conversion process in Position Adjustment is as follows;**1. Input to the form in Setting Tool**

Unit	Value Setting condition
mm	The value is adjustable in increments of ± 0.1 mm and rounded to the 1st decimal place.
inch	The value is adjustable in increments of ± 0.01 inch and rounded to the 2nd decimal place.
dot	The value is adjustable in increments of ± 1 dot and rounded to an integer place.

2. Units Conversion process

1) When sending the value to the printer

The setting value is transmitted as **dot** information to the printer.

Case	Conversion process	Calculation (Setting value = A)		Rounding method
Case 1	mm \Rightarrow dot	203dpi	$A / 25.4 \times 203$	Rounded down to an integer place
		300dpi	$A / 25.4 \times 300$	
Case 2	inch \Rightarrow dot	203dpi	$A \times 203$	
		300dpi	$A \times 300$	

2) When getting the value from the printer

The setting value is transmitted as **dot** information from the printer.

Case	Conversion process	Calculation (Getting value = B)		Rounding method
Case 3	dot \Rightarrow mm	203dpi	$B \times 25.4 / 203$	Rounded down to the 1st decimal place. e.g. 2.183 \rightarrow 2.1
		300dpi	$B \times 25.4 / 300$	
Case 4	dot \Rightarrow inch	203dpi	$B / 203$	Rounded down to the 2nd decimal place. e.g. 2.117 \rightarrow 2.11
		300dpi	$B / 300$	

"mm/inch \Leftrightarrow dot" conversion always has a calculation difference in converting units. These are cases where the setting value entered in the Setting Tool may change slightly due to requirements of the conversion process.

e.g. In case of **3.2** mm setting :

$$3.2 / 25.4 \times 203 = 25.5 \Rightarrow \mathbf{25} \text{ dot (Sending value to the printer)}$$

$$\mathbf{25} \times 25.4 / 203 = 3.12 \Rightarrow \mathbf{3.1} \text{ mm (Getting value from the printer)}$$

COM

The **COM** tab provides the settings of the RS-232C port. When you use COM as your port, make sure the settings in the **COM** tab are the same as the port settings, or your printer won't work properly.

The screenshot shows the 'COM' tab selected in the utility. Below the 'Send' and 'Get' buttons, the 'RS-232C' settings are displayed in a table-like format:

Baud Rate:	9600
Data Length:	8
Parity:	None
Stop Bit:	1
Flow Control:	XON/XOFF(DC1/DC3)

Property Name	Description
Baud Rate	The rate of signals transmitted per second. The larger the number, the faster the data transmission.
Data Length	The length of the data transmitted. It can be set to 7 or 8 bits.
Parity	It can be set to Odd , Even or None . A parity bit is added to a string of data bits to check if the data is correct. Odd The total number of "ones" in the data plus the parity bit is an odd number. Even The total number of "ones" in the data plus parity bit is an even number. None No parity check is used.
Stop Bit	The stop bit is at the end of a string of data bits. It is used in asynchronous transmission to let the receiver know that the string of data bits being transmitted is end.
Flow Control	Flow control is used to control the data flow between the computer and your printer. XON/XOFF (DC1/DC3) It is software flow control that uses control characters to handle data transmission. When your printer is unable to process the data the computer send, it sends an XOFF signal to tell the

	<p>computer to stop sending data; once your printer is able to accept data, it sends an XON signal to notify the computer to resume sending data.</p> <p>RTS It is hardware flow control that uses dedicated wires to handle data transmission. When the computer is ready to send data to your printer, it sends a Request to Send (RTS) signal to your printer. If your printer is able to accept the data, it sends a Clear to Send (CTS) signal to the computer. That is, the computer starts sending data when it sees CTS on; it stops sending when it sees CTS off.</p> <p>None No control is used for the handshake.</p>
--	--

LAN

The **LAN** tab provides network settings, including **TCP/IP**, **Current TCP/IP**, **Protocol**, **Server**, **WINS** and **SNMP Trap**.

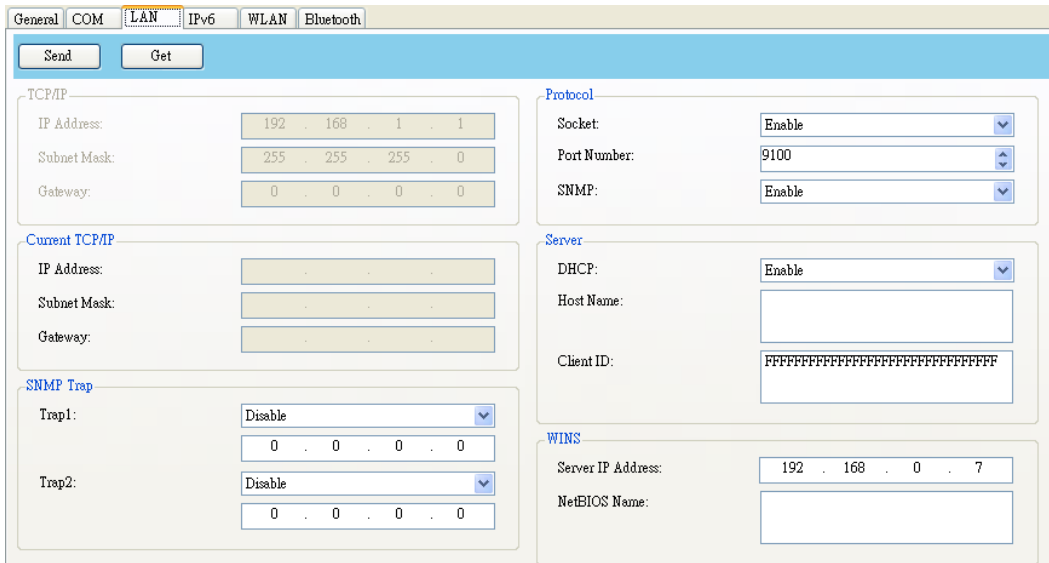

Property Name	Description
IP Address (TCP/IP)	The static IP address of your printer.
Subnet Mask (TCP/IP)	The manually specified subnet mask of your printer.
Gateway (TCP/IP)	The manually specified gateway of your printer.
IP Address (Current TCP/IP)	The current IP address of your printer.
Subnet Mask (Current TCP/IP)	The current subnet mask of your printer.

Property Name	Description
Gateway (Current TCP/IP)	The current gateway of your printer.
Socket	Enable The host communicates with your printer via the socket. Disable Disable the socket.
Port Number	The LAN port number of your printer.
SNMP	Enable The host gets or sets parameters registered as SNMP entities. Disable Disable SNMP.
DHCP	Enable The DHCP server assigns an IP address, the subnet mask and the gateway to your printer automatically. By default, it is enabled. Disable You need to specify an IP address, the subnet mask and the gateway to your printer manually.
Host Name	It is the name of a DHCP client. The host name allows up to 32 alphanumeric characters. You can leave it blank or type a name you want. By default, there is no host name.
Client ID	It is an arbitrary value sent to the DHCP server to reserve an IP address for your printer. Client ID allows up to 32 hexadecimal characters. If you leave it blank, your printer automatically assigns "FFFFFFFFFFFFFFFFFFFFFFFFFFFFFFFF" as the client ID.
Server IP Address	If you have WINS server in your local network, type IP address in. WS2 only accept one WINS server.
NetBIOS Name	NetBIOS Name only works on WINS server. Name the printer to replace IP address. It allows up to 15 characters and uppercase only.
Trap 1	Trap is a message type of SNMP. When Trap 1 is enabled and its IP address is set correctly, your printer alerts the computer of the specified IP address as your printer is experiencing problems.
Trap 2	Same as Trap 1.

Set up LAN connection

If you want to use the **LAN** or **Multi-LAN** port to transfer data, you need to set up the network connection in the **LAN** tab.

1. Connect your printer and computer to a network device (hub, switch or router) with Ethernet cables.
2. In the **Input/Output Port** list, click **USB** or **COM**.

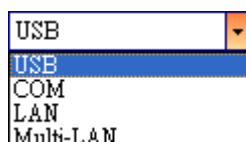

3. In the **Navigation** pane, click **Parameter Setting**, and click the **LAN** tab.

The screenshot shows the LAN configuration window with the following sections:

- TCP/IP:** IP Address (192.168.1.1), Subnet Mask (255.255.255.0), Gateway (0.0.0.0)
- Current TCP/IP:** Empty fields for IP Address, Subnet Mask, and Gateway.
- SNMP Trap:** Trap1 (Disable, 0.0.0.0), Trap2 (Disable, 0.0.0.0)
- Protocol:** Socket (Enable), Port Number (9100), SNMP (Enable)
- Server:** DHCP (Enable), Host Name (empty), Client ID (FFFFFFFFFFFFFFFFFFFFFFFFFFFFFFFF)
- WINS:** Server IP Address (192.168.0.7), NetBIOS Name (empty)

4. Do one of the following to configure your TCP/IP settings:
 - If you have a static IP address, fill the **IP Address**, **Subnet Mask** and **Gateway** box under **TCP/IP** according to your network settings and click **Send**.

The screenshot shows the TCP/IP configuration section with the following values:

- IP Address:** 155 . 181 . 255 . 28
- Subnet Mask:** 79 . 210 . 220 . 8
- Gateway:** 255 . 252 . 234 . 220

6 Set Up Interface Connection by SATO WS2 Printer Utility

- If you don't have a static IP address, make sure **DHCP** is enabled and click **Send**.

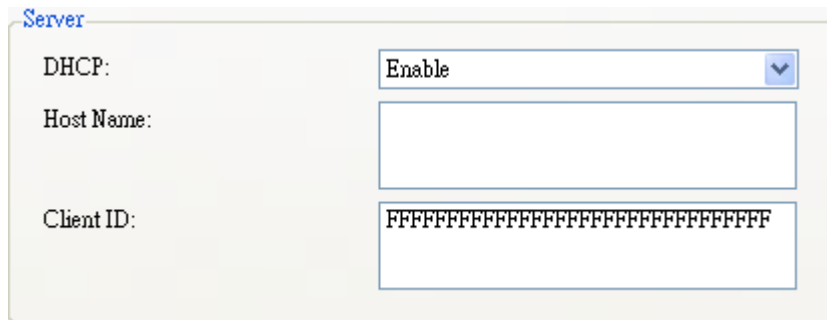

5. After your printer restarts, click **Get** to get the TCP/IP information of your printer. If you are using a static IP address, you'll get the same TCP/IP settings as it is in the previous step; if you are using DHCP, The DHCP server will automatically populate the **IP Address**, **Subnet Mask** and **Gateway** boxes under **Current TCP/IP**.

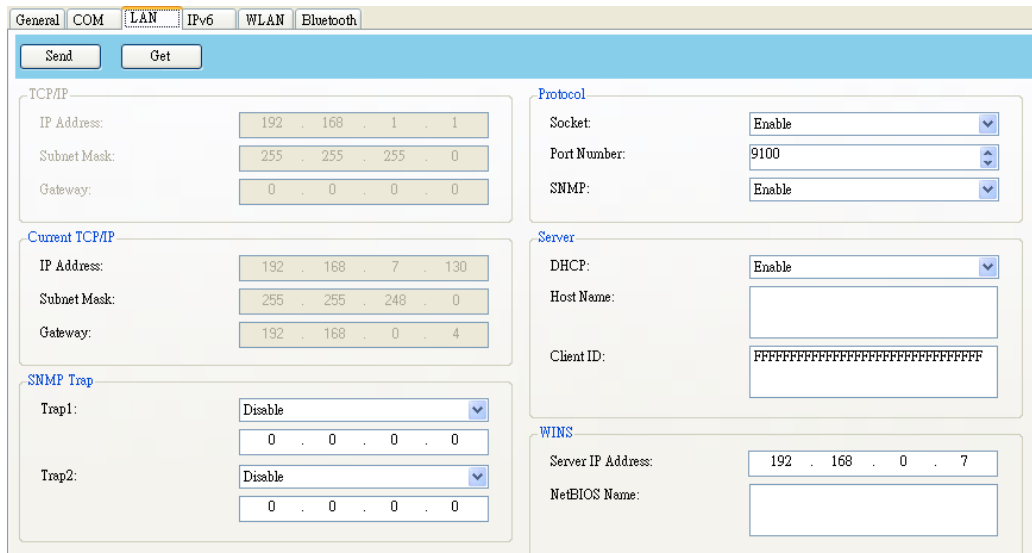

6. In the **Input/Output Port** list, click **LAN**, and click **Setting**.



7. In the **Setting LAN** dialog box, do one of the following to configure your IP address:

- If you are using a static IP address, in the **IP Address** box, enter the IP address under **TCP/IP** in the **LAN** tab, and then click **OK**.

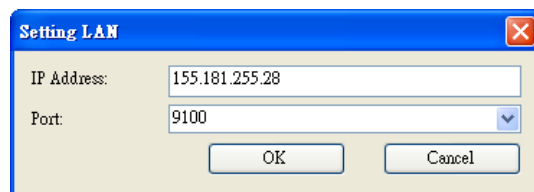

- If you are using a dynamic IP address provided by DHCP, in the **IP Address** box, enter the IP address under **Current TCP/IP** in the **LAN** tab, and then click **OK**.

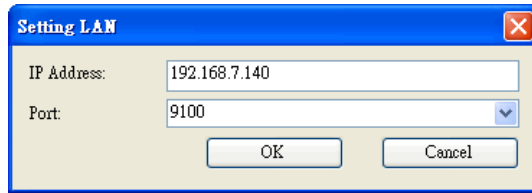

Note When DHCP is enabled and your printer is idle for a long time, the IP address of your printer may change. Click **Get** to get the new IP address if you find the current IP address is not working.

IPv6

The **IPv6** tab provides IPv6 settings, including **IPv6** and **Current IPv6**.

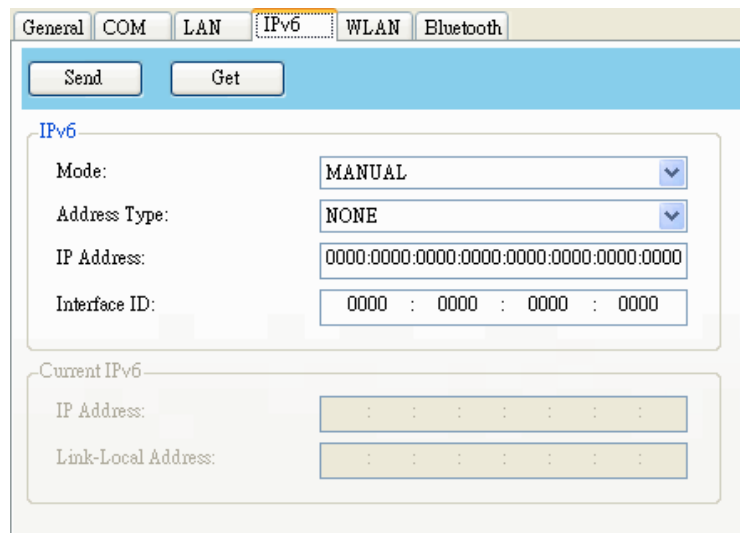

Property Name	Description
Mode	<p>It determines how you get the IPv6 address of your printer.</p> <p>MANUAL Specify an IPv6 address manually.</p> <p>DHCPv6 An IPv6 address is assigned by a Dynamic Host Configuration Protocol for IPv6 (DHCPv6) server.</p> <p>AUTO It uses a stateless address that doesn't require a DHCPv6 server to allocate an IP address. A host generates an IPv6 address from router advertisements and a MAC address. Stateless auto-configuration supports plug and play functionality, which allows the printer to generate an IPv6 address by itself once it connects to an IPv6 network.</p>

Property Name	Description
Address Type	<p>It is the IPv6 address type of your printer.</p> <p>NONE The system won't use the address you specified to generate an IPv6 address. It sets 0000::0000 as the IPv6 address.</p> <p>NORMAL It uses a 128-bit unicast address that you specified.</p> <p>EUI It is 64-bit Extended Unique Identifier (EUI-64) that generates the second half of a unicast IPv6 address (last 64 bits) from a MAC address. You can also specify the second half of the address by entering the interface ID.</p> <p>ANY It uses a 128-bit anycast address that you specify. The printer needs to remember that the current address is an anycast address, since its format is the same as a unicast address.</p>
IP Address (IPv6)	The static IPv6 address of your printer.
Interface ID	Short for interface identifier. It is used to identify the network interface of a host. You can specify the interface ID here.
IP Address (Current IPv6)	The current IPv6 address of your printer.
Link-Local Address	It is used for communications on a local network. The address always starts with FE80.

Set up IPv6 connection

Before you set up IPv6, make sure you have IPv6 connectivity.

- Do one of the following to configure your IPv6 settings:
 - If you have a static IPv6 address, in the **Mode** list, click **MANUAL**; in the **IP Address** box, enter your IPv6 address, and click **Send**.

The screenshot shows the IPv6 configuration interface. At the top, there are tabs for 'General', 'COM', 'LAN', 'IPv6', 'WLAN', and 'Bluetooth'. Below the tabs are 'Send' and 'Get' buttons. The 'IPv6' section contains the following fields:

- Mode:** A dropdown menu currently showing 'MANUAL'.
- Address Type:** A dropdown menu currently showing 'NORMAL'.
- IP Address:** A text input field containing the IPv6 address '2610:0008:6800:2f3b:02ab:00fe:fe9a:030a'.
- Interface ID:** A text input field containing '0000 : 0000 : 0000 : 0000'.

- If you don't have a static IPv6 address, in the **Mode** list, click **DHCPv6**; in

the **Address Type** list, click **Normal**, and click **Send**.

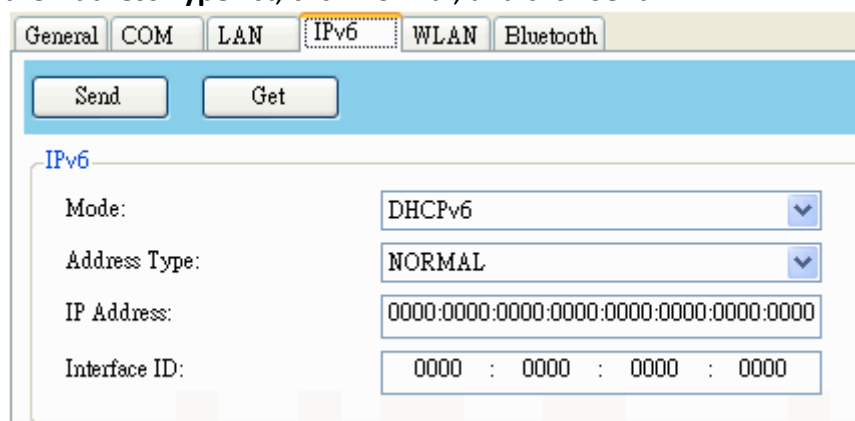

2. After your printer restarts, click **Get** to get its IPv6 information. If you are using a static IPv6 address, you'll get the same settings as it is in the previous step; if you are using DHCPv6, the DHCPv6 server will automatically populate the **IP Address** and **Link-Local Address** boxes under **Current IPv6**.

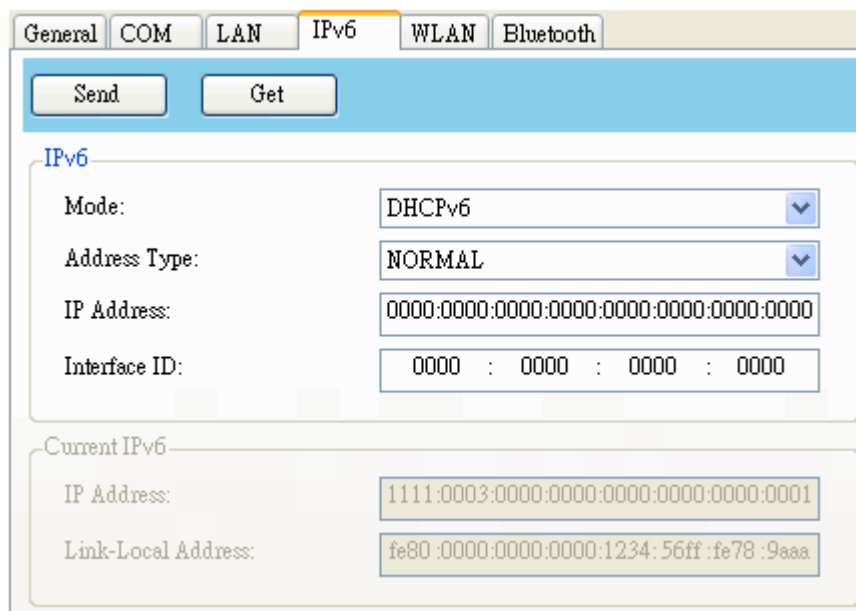

3. In the **Input/Output Port** list, click **LAN**, and click **Setting**.



4. In the **Setting LAN** dialog box, do one of the following to configure your IP address:

- If you are using a static IP address, in the **IP Address** box, enter the IP address under **IPv6** in the **IPv6** tab and click **OK**.

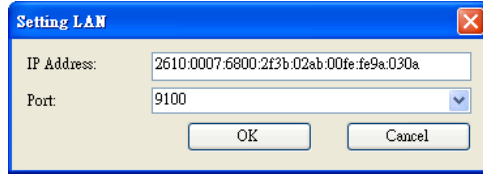

- If you are using a dynamic IP address provided by DHCPv6, in the **IP Address** box, enter the IP address under **Current IPv6** in the **IPv6** tab and click **OK**.

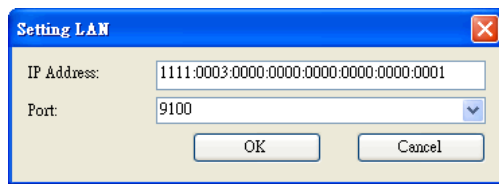

Note If your IPv6 address has consecutive zeros, you can use a double-colon to compress them. For example, if your address is 2607:f0d0:1002:0051:0000:0000:0000:0006, you can shorten it like this: 2607:f0d0:1002:0051::0006. Remember that the double-colon can appear only once in the address. The leading zeros in a section can also be removed, so the shortest version of your address can be written as 2607:f0d0:1002:51::6.

WLAN

The **WLAN** tab provides wireless network settings, including **IPv4**, **Current IPv4**, **Authentication**, **Information**, **WEP**, **WPA**, **Initialization**, **Protocol**, **Current Protocol**, **Server** and **EAP**.

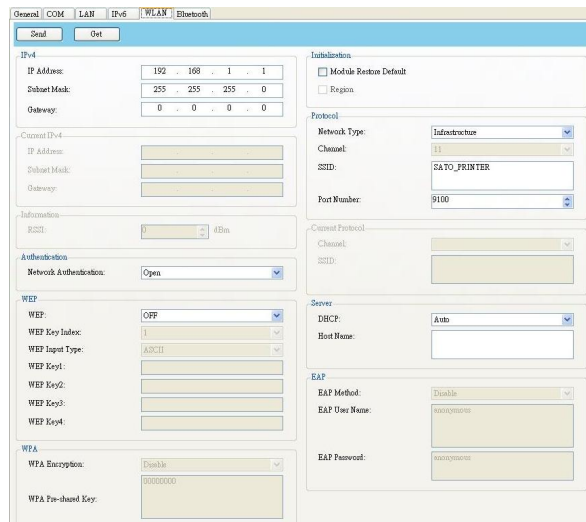

Property Name	Description
IP Address (IPv4)	The static IPv4 address of your printer.
Subnet Mask (IPv4)	The manually specified IPv4 subnet mask of your printer.
Gateway (IPv4)	The manually specified IPv4 gateway of your printer.
IP Address (Current IPv4)	The current IPv4 address of your printer.
Subnet Mask (Current IPv4)	The current IPv4 subnet mask of your printer.
Gateway (Current IPv4)	The current IPv4 gateway of your printer.
RSSI	Short for received signal strength indicator. It measures your Wi-Fi signal strength. The bigger the number, the stronger the signal.
Network Authentication	<p>Open It allows any device to authenticate to an access point (AP) and gain access to a network, but only the device with the correct WEP key can receive encrypted data while the AP uses WEP encryption.</p> <p>WPA-Personal WPA-Personal uses Pre-Shared Key (PSK) authentication, in which all users use the same password to access a network. WPA is designed to replace WEP. It uses RC4 encryption as WEP, but provides extra security through TKIP.</p> <p>WPA2-Personal WPA2-Personal includes all features of WPA-Personal, but it uses AES encryption to enhance security.</p> <p>802.1X 802.1X is an IEEE standard that provides EAP-based authentication methods for network access control. It enhances security by centralizing user identification, authentication and key management.</p> <p>WPA-Enterprise WPA-Enterprise offers centralized control over a network. It requires an 802.1X authentication server (RADIUS server) to validate users. Each user needs to enter individual username and password to access a network. It uses TKIP and RC4 algorithm to encrypt data.</p> <p>WPA2-Enterprise WPA2-Enterprise includes all features of WPA-Enterprise, but it uses AES encryption to enhance security.</p>
WEP	<p>ON Turn on WEP encryption.</p> <p>OFF Turn off WEP encryption.</p>

Property Name	Description
WEP Key Index	The default key of WEP. You can set four keys and choose one of them as the default.
WEP Input Type	<p>The type of your WEP key.</p> <p>ASCII If your key is generated in ASCII, select this. ASCII includes the English alphabet, numbers and punctuation symbols.</p> <p>HEX If your key is generated in hexadecimal (HEX), select this. HEX includes the numbers 0 to 9 and the letters A to F.</p>
WEP Key 1-4	You can store four 128-bit WEP keys.
WPA Encryption	<p>It shows encryption methods depending on your network authentication.</p> <p>AUTO It allows the access point to use either TKIP or AES encryption.</p> <p>TKIP It is available for WPA-Personal and WPA-Enterprise. TKIP stands for Temporal Key Integrity Protocol. It is part of 802.11i standard of Wireless LAN. It enhances the security of WEP. TKIP uses 128-bit encryption. It dynamically changes keys for each packet using a rekeying mechanism, providing a strong protection against attackers.</p> <p>AES It is available for WPA2-Personal and WPA2-Enterprise. AES stands for Advanced Encryption Standard. It uses a serial of mathematical operations that repeatedly rearrange data to encrypt it.</p> <p>Note 802.11n can only use AES encryption.</p>
WPA Pre-shared Key	It is a key shared between two parties that use a secure channel for communication. Anyone who knows the key can access the network. The length can be 1-63 alphanumeric characters excluding double quotation marks (“”). Pre-shared key authentication is for home or small offices.
Module Restore Default	It resets all values in the Wi-Fi module.
Network Type	<p>It determines how you connect your printer to a network.</p> <p>Infrastructure If you connect through an access point, select this.</p>

Property Name	Description
	Ad hoc If you connect through a device which has connected to a network, select this. In Ad hoc mode, you can only use Open authentication.
Region	The country or region.
Channel	The Wi-Fi channel. You need to use the same channel as other devices for communication. The available channel varies according to your region.
SSID	The service set identifier. It is the name of a wireless network.
Port Number	The wireless LAN port number of your printer.
Channel (Current)	The current Wi-Fi channel.
SSID (Current)	The current service set identifier.
DHCP	Auto It tries to get an IP address from a DHCP server first. If failed, it uses the specified one. Enable It keeps trying to get an IP address from a DHCP server until it succeeds. Disable It uses the specified IP address.
Host Name	It is the name of a DHCP client. The host name allows up to 32 alphanumeric characters. You can leave it blank or type a name you want. By default, there is no host name.
EAP Method	It is available for 802.1X , WPA-Enterprise and WPA2-Enterprise authentication. EAP-LEAP LEAP stands for Lightweight Extensible Authentication Protocol. It changes the WEP key for each session, preventing attackers retrieving data by cracking the key. EAP-TLS TLS stands for Transport Layer Security. EAP-TLS requires both a client and a server to exchange digital certificates to authenticate each other. It uses Public Key Infrastructure (PKI) to protect communication. A server and a client need to obtain certificates from a certification authority (CA), and use these certificates to validate each other's identity. EAP-TTLS TTLS stands for Tunneled Transport Layer Security. It has two stages. First, a server sends its certificate to a client after it received an

Property Name	Description
	<p>authentication request. This certificate is used to create an encrypted tunnel (TLS tunnel) between the server and the client. Second, both sides exchange attribute-value pairs (AVP) through this tunnel.</p> <p>PEAP Short for Protected Extensible Authentication Protocol. Similar to EAP-TTLS, it creates an encrypted tunnel between a server and a client in the first stage. After that, it starts the second EAP exchange through this tunnel.</p> <p>EAP-FAST FAST stands for Flexible Authentication via Secure Tunneling. Similar to PEAP, it has two stages. First, it uses a Protected Access Credentials (PACs) to create an encrypted tunnel. Second, it authenticates the client to the server within the tunnel.</p>
EAP Username	The username for EAP authentication. It accepts 1-63 alphanumeric characters.
EAP Password	The password for EAP authentication. It accepts 1-32 alphanumeric characters.

Set up WLAN connection

Before you set up a wireless LAN connection, make sure your computer has connected to a wireless network.

1. In the **Input/Output Port** list, click **USB** or **COM**.

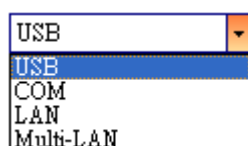

6 Set Up Interface Connection by SATO WS2 Printer Utility

2. In the **Navigation** pane, click **Parameter Setting**, and click the **WLAN** tab.

The screenshot shows the WLAN configuration interface with the following sections and fields:

- General:** Send, Get buttons.
- IPv4:** IP Address (192.168.1.1), Subnet Mask (255.255.255.0), Gateway (0.0.0.0).
- Current IPv4:** IP Address, Subnet Mask, Gateway (empty).
- Information:** RSSI (0 dBm).
- Authentication:** Network Authentication (Open).
- WEP:** WEP (OFF), WEP Key Index (1), WEP Input Type (ASCII), WEP Key1-4 (empty).
- WPA:** WPA Encryption (Disable), WPA Pre-shared Key (00000000).
- Initialization:** Module Restore Default, Region (checkboxes).
- Protocol:** Network Type (Infrastructure), Channel (11), SSID (SATO_PRINTER), Port Number (9100).
- Current Protocol:** Channel, SSID (empty).
- Server:** DHCP (Auto), Host Name (empty).
- EAP:** EAP Method (Disable), EAP User Name (anonymous), EAP Password (anonymous).

3. In the **SSID** box, enter the network name you've connected, and do one of the following to enter your password:

The close-up shows the SSID field with the text "dlink" entered.

- If you're using **Open** and **WEP** is on, choose your WEP password type in the **WEP Input Type** list. Next, enter your WEP password in one of the **WEP Key** box, and select the key you want to use from the **WEP Key Index** list.

WEP

WEP:	ON
WEP Key Index:	1
WEP Input Type:	ASCII
WEP Key1:	00000000
WEP Key2:	
WEP Key3:	
WEP Key4:	

- If you're using **WPA-Personal** or **WPA2 Personal**, enter your password in the **WPA Pre-shared Key** box.

WPA

WPA Encryption:	AUTO
WPA Pre-shared Key:	00000000

- If you're using **802.1X**, **WPA-Enterprise** or **WPA2 Enterprise**, choose your EAP authentication method in the **EAP Method** list, and enter your username and password in **EAP User Name** and **EAP Password** boxes respectively. If you're using TTLS mode, you can choose the TTLS encryption method from the **TTLS Method** list.

EAP

EAP Method:	EAP-TTLS
EAP User Name:	anonymous
EAP Password:	anonymous

4. Do one of the following to configure your IPv4 settings:
 - If you have a static IP address, fill the **IP Address**, **Subnet Mask** and **Gateway** box under **IPv4** according to your network settings, make sure **DHCP** is disabled, and click **Send**.

IPv4

IP Address:	155 . 181 . 255 . 28
Subnet Mask:	79 . 210 . 220 . 8
Gateway:	255 . 252 . 234 . 220

Server

DHCP:	Disable
Host Name:	

- If you don't have a static IP address, make sure **DHCP** is enabled and click **Send**.

Server

DHCP:	Enable
Host Name:	

5. After your printer restarts, click **Get** to get the IPv4 information of your printer. If you are using a static IP address, you'll get the same settings as it is in the previous step; if you are using DHCP, the DHCP server will automatically populate the **IP Address**, **Subnet Mask** and **Gateway** boxes under **Current IPv4**.

Current IPv4

IP Address:	192 . 168 . 0 . 120
Subnet Mask:	255 . 255 . 255 . 0
Gateway:	192 . 168 . 0 . 1

6. In the **Input/Output Port** list, click **LAN**, and click **Setting**.



7. In the **Setting LAN** dialog box, do one of the following to configure your IP address:

- If you are using a static IP address, in the **IP Address** box, enter the IP address under **IPv4** in the **WLAN** tab and click **OK**.

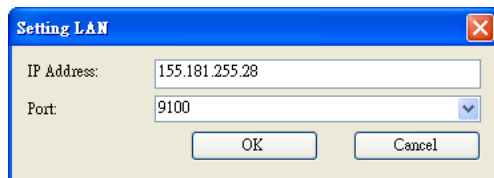

- If you are using a dynamic IP address provided by DHCP, in the **IP Address** box, enter the IP address under **Current IPv4** in the **WLAN** tab and click **OK**.

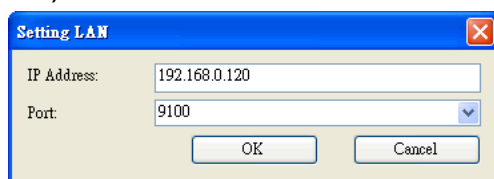

Bluetooth

The **Bluetooth** tab provides Bluetooth settings.

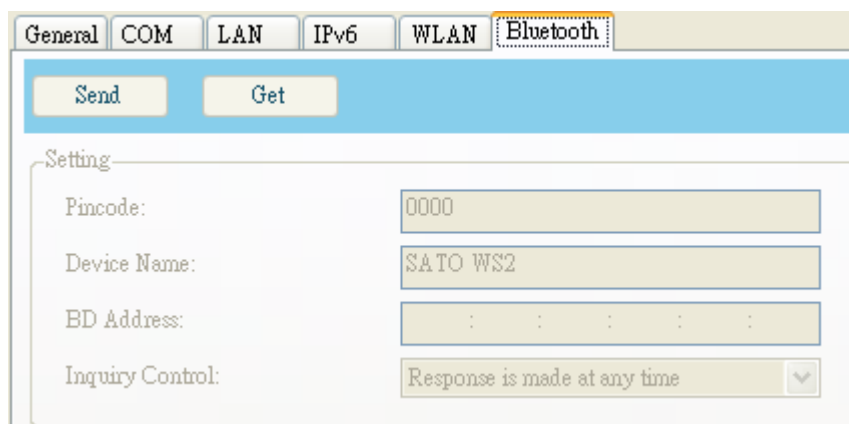

Property Name	Description
Pincode	The Bluetooth PIN code of your printer. The new PIN code takes effect when you reconnect your printer to your computer.
Device Name	The Bluetooth device name of your printer. The new device name takes effect after you reconnect your printer to your computer.
BD Address	The Bluetooth MAC address of your printer.
Inquiry Control	It determines how your printer is detected by other Bluetooth devices.

Property Name	Description
	<p>Response is made at any time Your printer is always detectable.</p> <p>No response Your printer is not detectable.</p> <p>Response only within 60sec after a power on Your printer is detectable in 60 seconds after it is turned on.</p>

Reset parameter setting

If you want to reset **Parameter Setting**, do this:

1. In **Parameter Setting**, right-click in the blank area in any tab.

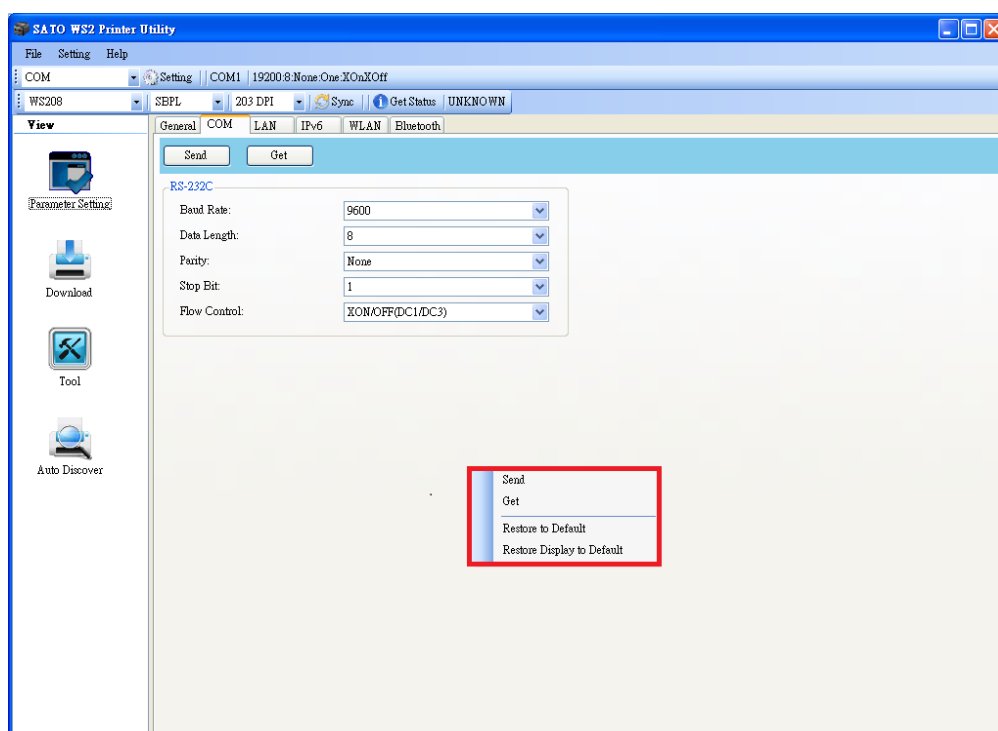

2. In the shortcut menu, do one of the following to reset **Parameter Setting**:

- If you want to restore all of the settings to their default values, click **Restore to Default**.

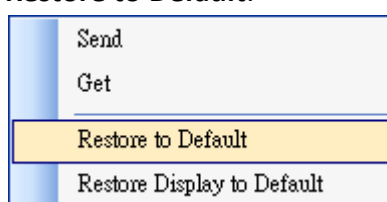

- If you want to restore the settings of the current tab to their default values, click **Restore Display to Default**.

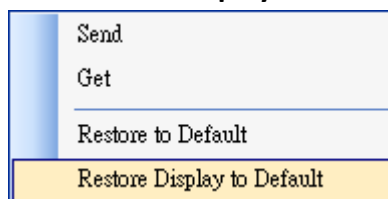

Download

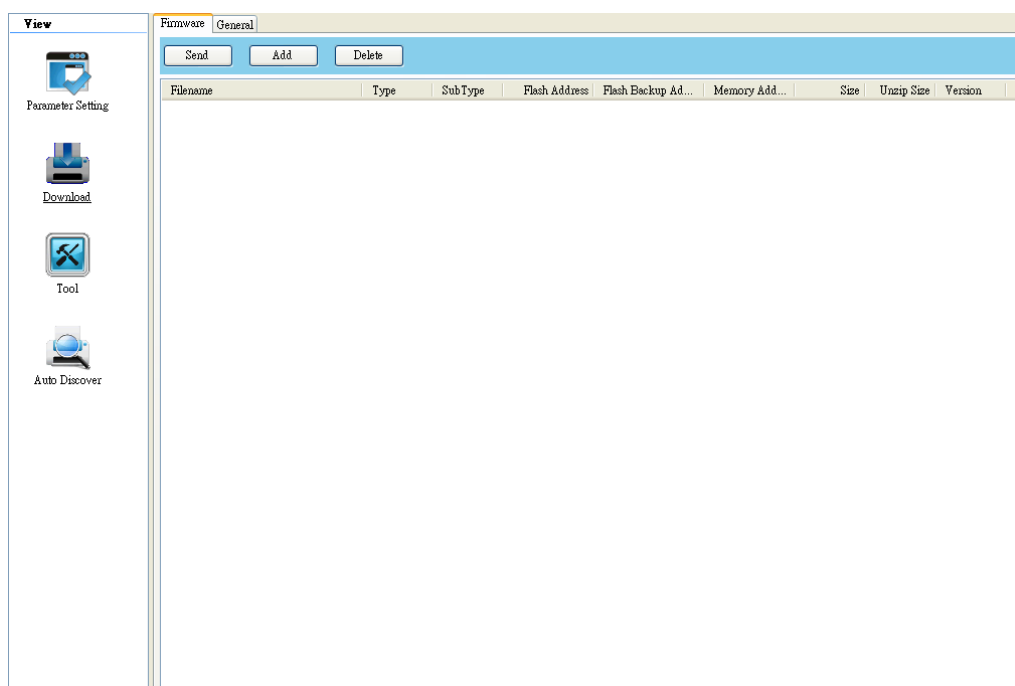

Download is used to download files to your printer. Tabs in **Download** are related to the emulation language you choose. Remember that you need to set up a network connection before you use the **LAN** or **Multi-LAN** port for the data transfer. For further details, see [Set up LAN connection](#), [Set up IPv6 connection](#) and [Set up WLAN connection](#).

Firmware

The **Firmware** tab displays in all emulation modes. It is used to update firmware. For information about update firmware in SATO WS2 Printer Utility, see [Update firmware in SATO WS2 Printer Utility](#).

General

The **General** tab displays in all emulation modes. It is used to send command files to your printer and perform tasks. Command files only run in their corresponding emulations. For example, SZPL command files only run in SZPL emulation.

To run commands on your printer:

1. Type your commands in any text editor, such as Notepad or Wordpad.
2. Save your commands as text files (.txt).
3. In the **Input/Output Port** list, click the port you want to use.

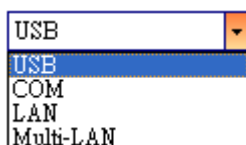

4. Click **Download** in the **Navigation** pane.

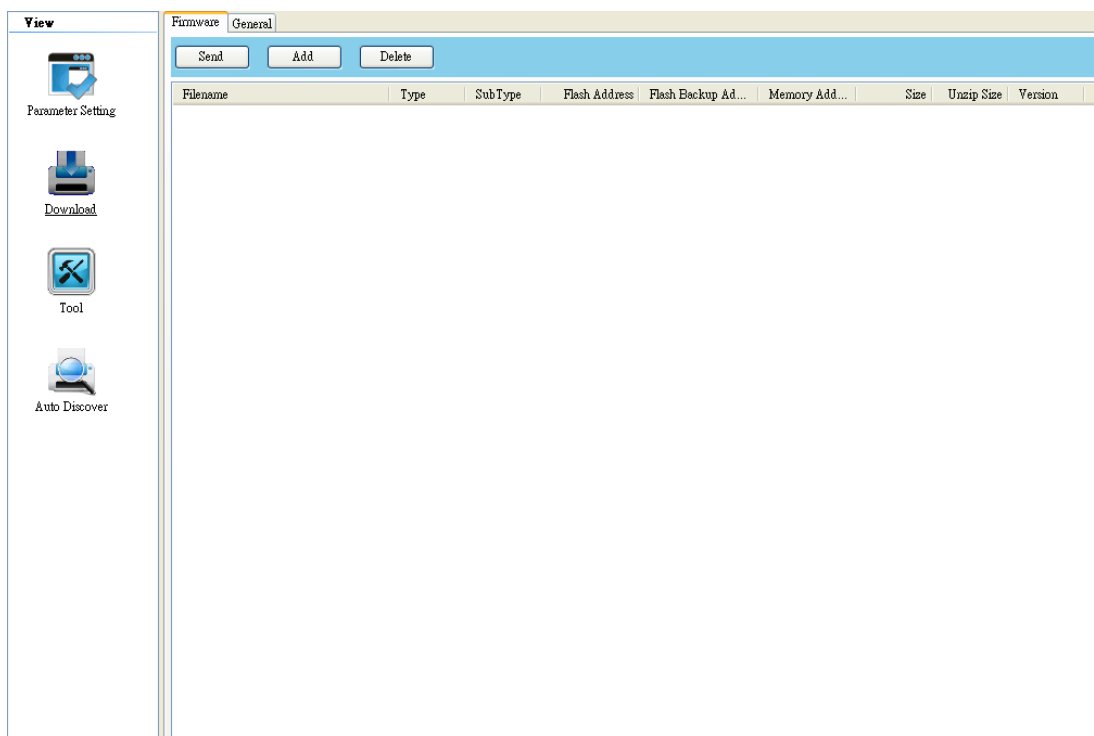

5. Under the **General** tab, right-click in the blank area and click **Add**.

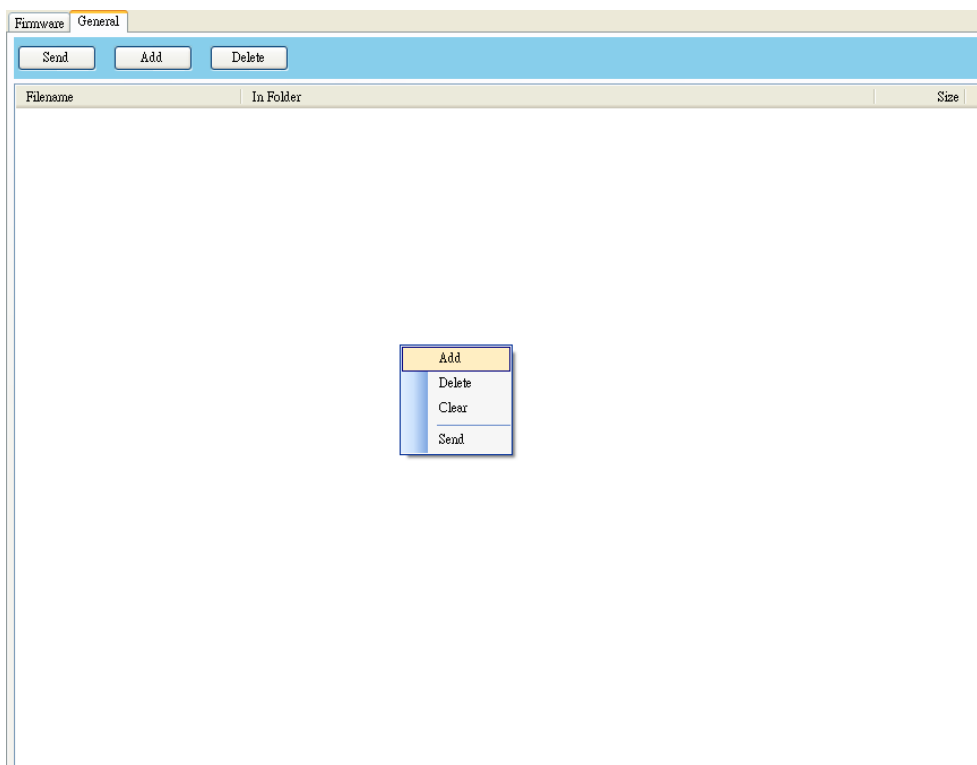

6. In the **Open** dialog box, browse to the folder that contains command files, select them and click **Open**. The command files you select must correspond to the emulation language you use.

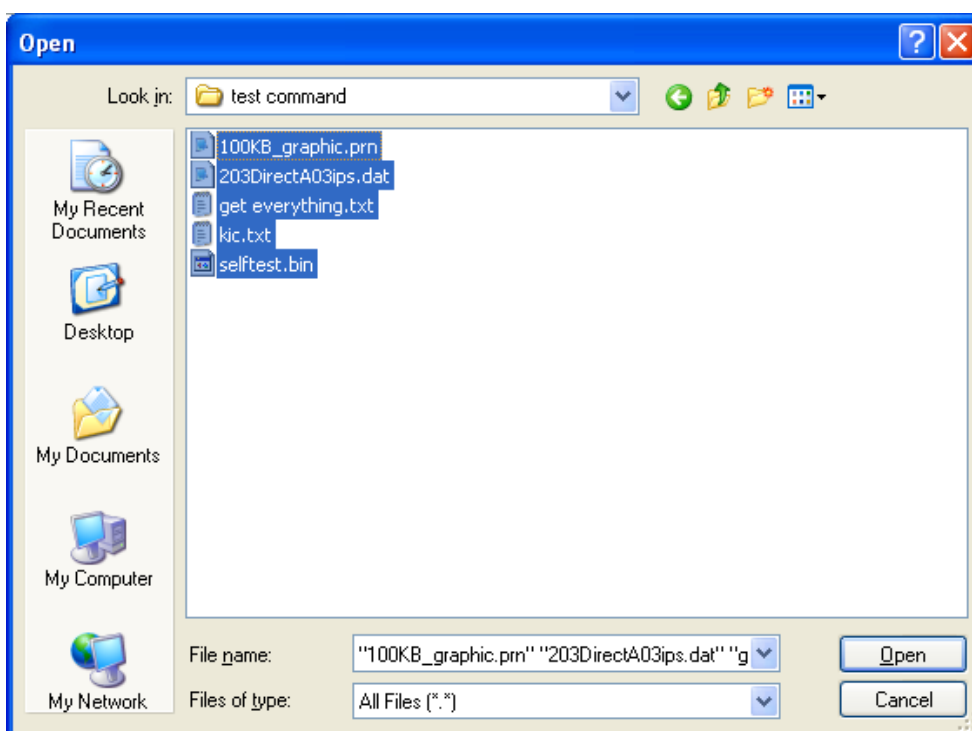

7. In the list, select the file you want to use. You can only select one file at a time.

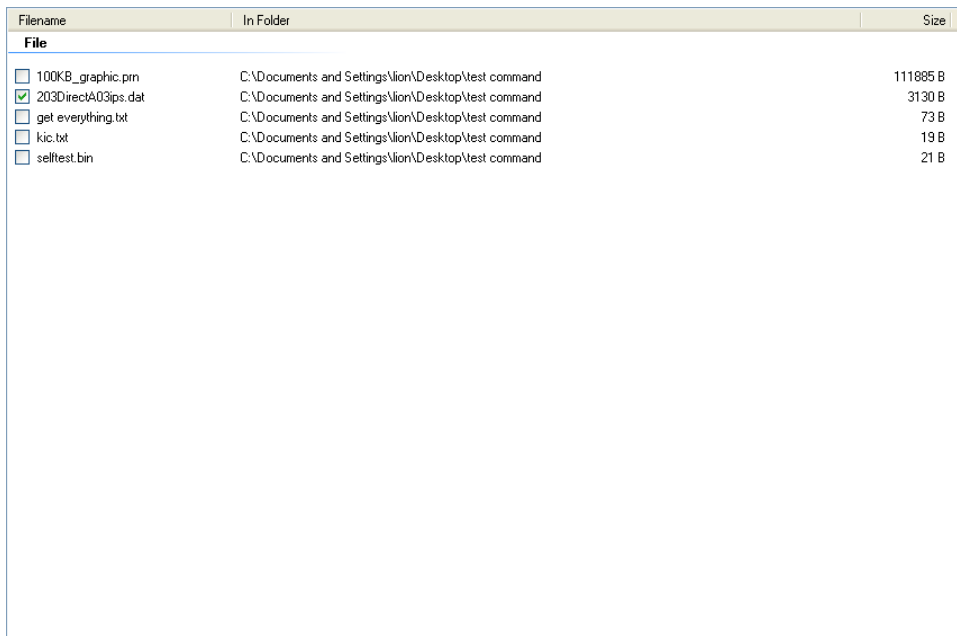

8. Click **Send** to run the command on your printer.

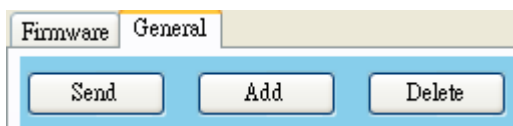

Note If you send a command file and your printer doesn't respond, it is possible that the emulation language is not set correctly. Click **Sync** to get the current setting of **Printer Emulation**.

Tool

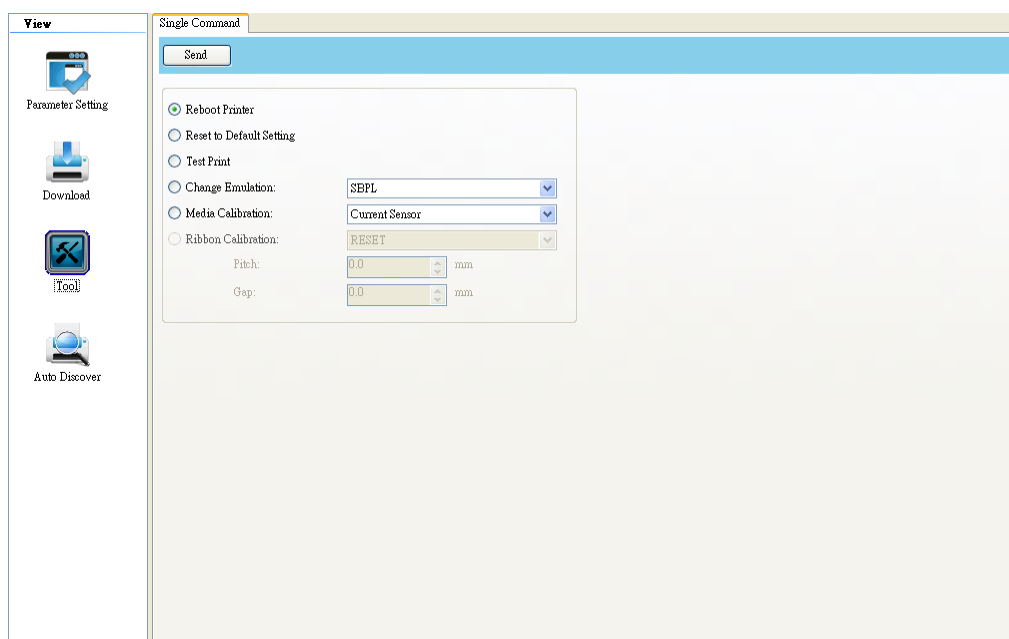

Tool is used to send specific commands to your printer.

Single Command

The **Single Command** tab which provides commands below.

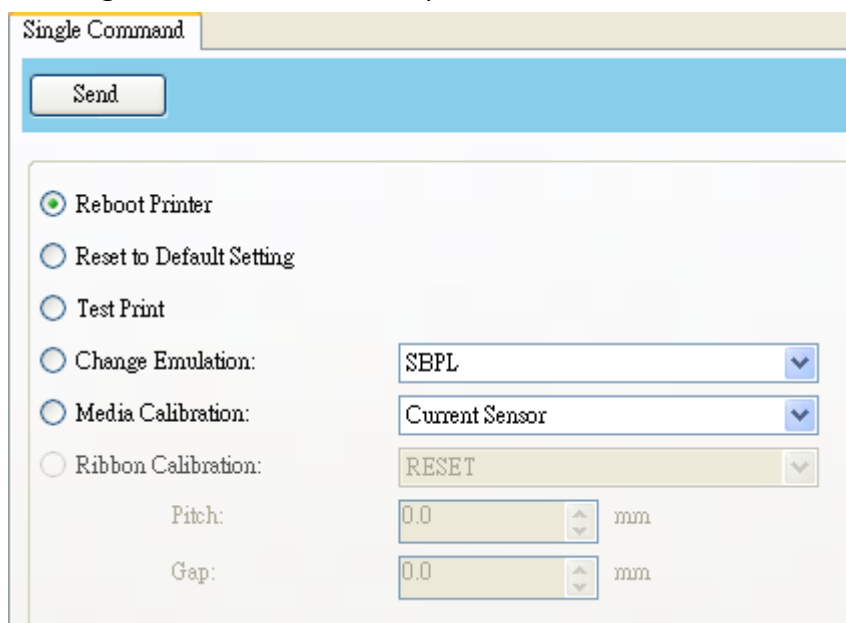

- **Reboot Printer** Restart your printer.
- **Reset To Default Setting** Reload factory settings.
- **Test Print** Run a self test to print a configuration label.
- **Change Emulation** Change the emulation language for your printer.
- **Media Calibration** Change the media sensor for your printer.
- **Ribbon Calibration** It calibrates the ribbon so that your print start position will be more accurate.
 - **RESET** Turn off **Ribbon Calibration**.
 - **ON** Turn on **Ribbon Calibration**. Enter the pitch and gap of your label in the scale boxes. For example, if the pitch of your label is 100 mm, enter 100 in the box; the gap of your label is 5 mm, enter 5 in the box.

Auto Discover

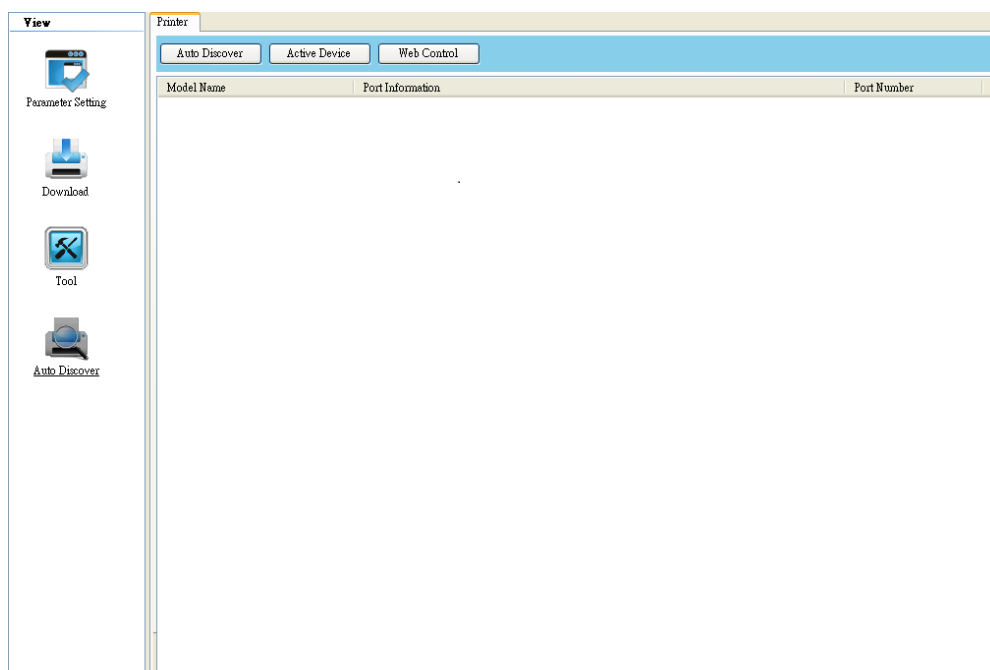

Auto Discover is used to find barcode printer. You can so easy and fast to find printer.

Printer

The **Printer** tab provides to search and control printer. Select a printer can rapidly change to control it.

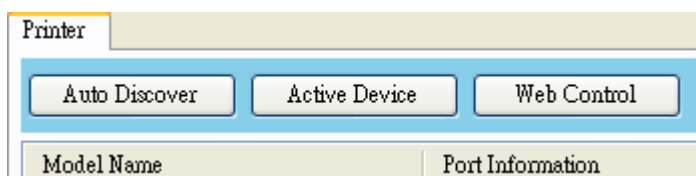

- **Auto Discover:** **Auto Discover** will show USB and LAN connected printer. It is based on SNMP protocol and using broadcast to search in private network. Click **Auto Discover**, It will display Model Name, Port Information(IP address) and Port number.
- **Active Device:** Select a device and click **Active Device**. Toolbar will be changed. If you click **Sync** and **Status** in the toolbar, then toolbar will be update. You can rapidly switch the printer by this function or select multiple printers to setup under **Multi-LAN** port.

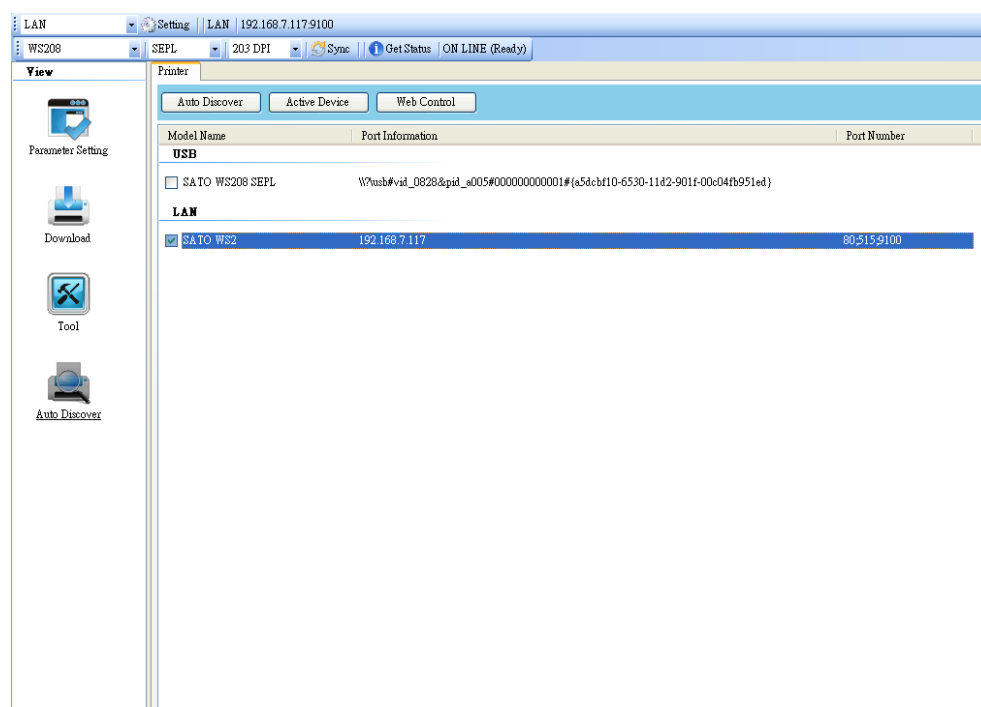

- **Web Control:**

If printer firmware supports web control, click **Web Control** to open a Web page. Default Login name and password is **admin**. You can also type the IP address to open **printer web setting tool** in your browser. **Printer web setting tool** is based on **Print Tool**. Each model may have a bit different setting because of the spec.

Parameter Setting	General	Send
General	Supply	
COM	Sensor Type: I-MARK ▾	
LAN	Ribbon Sensor: Direct Thermal ▾	
IPv6	Control	
Download	Feed Key: Feed ▾	
Firmware	Head Check (Power on): Disable ▾	
General	Auto Calibration: OFF ▾	
Tool	Reprint After Error: Enable ▾	
Single Command	Action	
Device Setting	Print Darkness: 16 (0 ~ 30)	
Web Tool Language	Print Speed: 5 ▾ (ps)	
Logout	Label	
	Unit: mm ▾	
	Width: 54.0 (0.0 ~ 50.8 mm)	
	Height: 25.4 (0.0 ~ 999.0 mm)	
	Position Adjustment	
	Unit: mm ▾	
	Horizontal Offset: 0.0 (-100.0 ~ 100.0 mm)	
	Vertical Offset: 0.0 (-100.0 ~ 100.0 mm)	
	Tear Off Offset: 0.0 (-12.0 ~ 12.0 mm)	
	Cutter/Dispenser Offset: 0.0 (-4.0 ~ 4.0 mm)	

6.3 Update firmware

Firmware is the code stored permanently in hardware. It instructs your printer to do its tasks. Benefits of updating firmware include new features, enhanced functionality and improved performance.



Caution Do not open the print module, disconnect your printer from the computer or cut your printer power during the firmware update.

Update firmware in SATO WS2 Printer Utility

This section describes how to update printer firmware in SATO WS2 Printer Utility.

6.3.1 Update via the USB Client or COM port

1. Connect your printer and the computer with a USB or a serial cable.
2. Make sure the print module is closed.
3. Turn on your printer, and start SATO WS2 Printer Utility.
4. In the **Input/Output Port** list, click **USB** or **COM**, and do one of the following:
 - If you are using the **USB** port, the **Port Name** and **Port Information** automatically shows the USB information. You don't need to do anything.

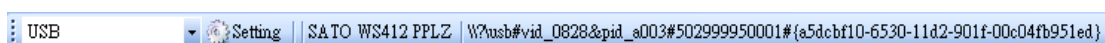

- If you are using the **COM** port, click **Setting**, and change the settings as you want. For example, you can change **Baud Rate** to a higher value to speed up the data transmission. Make sure the port settings are the same as those in the **COM** tab in **Parameter Setting**, or your printer won't work properly.

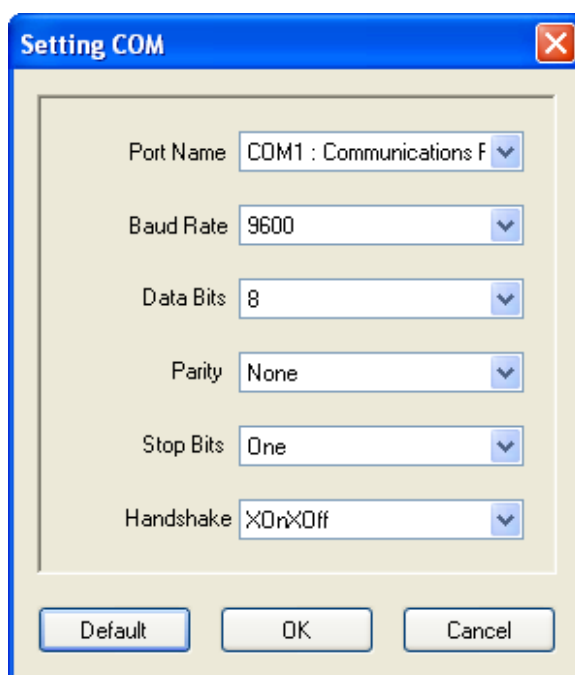

5. In the **Navigation** pane, click **Download**, and click the **Firmware** tab.

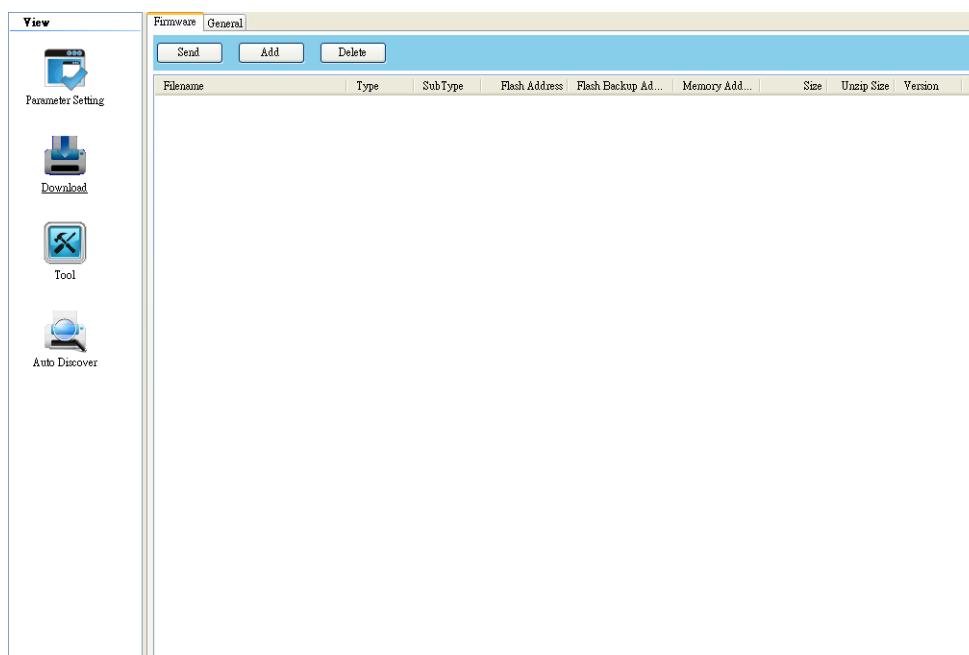

6. Right-click in the blank area and click **Add**.

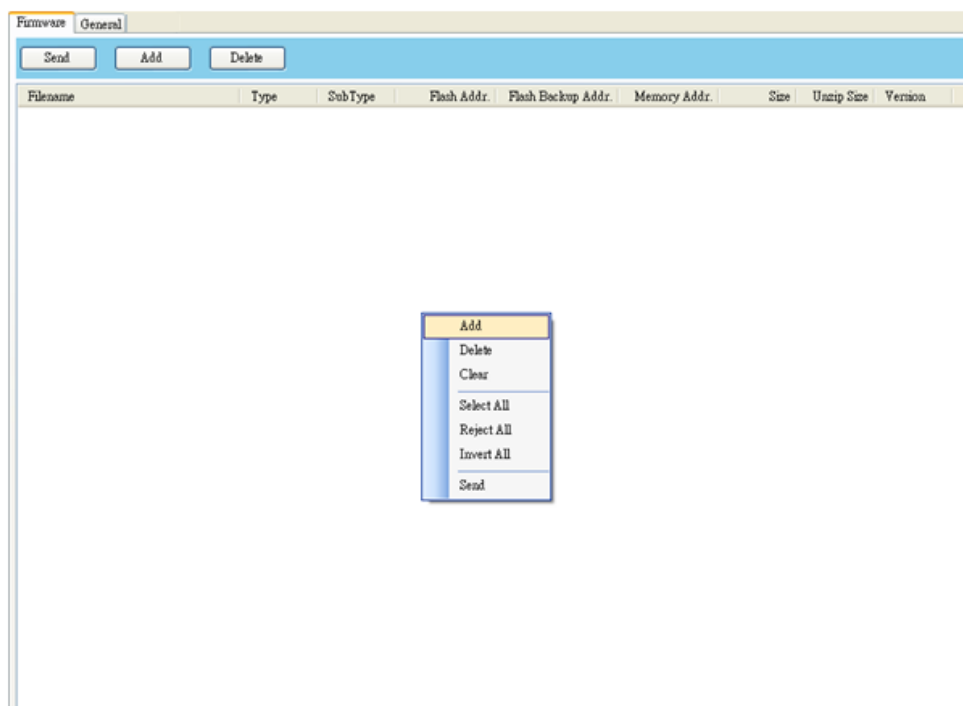

6 Set Up Interface Connection by SATO WS2 Printer Utility

7. In the **Open** dialog box, browse to the folder that contains the firmware files. Select all of them and click **Open**.

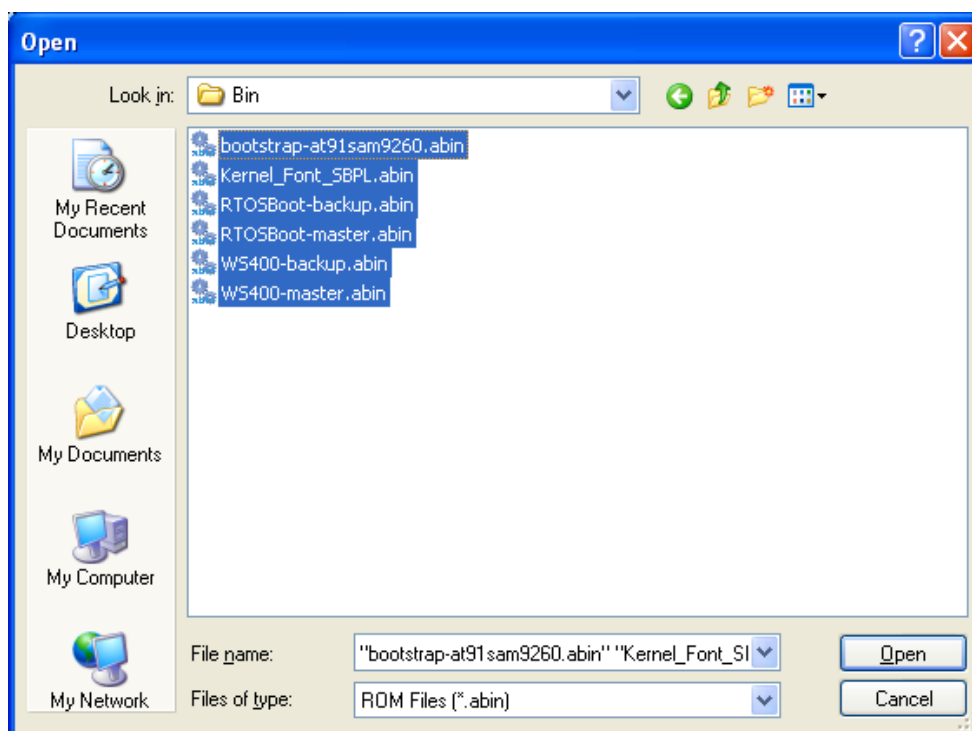

8. If you want to update specific files, select the check boxes of those files; if you want to update all of the firmware files, right-click in the blank area in the list, and click **Select All**.

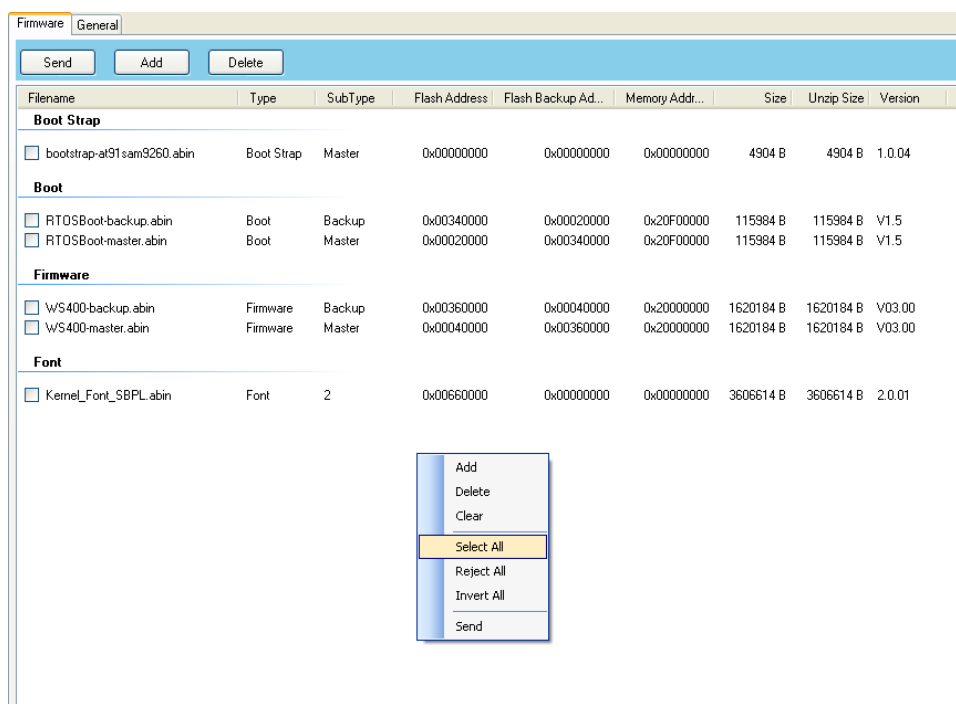

- Click **Send** to send the firmware files to your printer. During the transmission LED 1 blinks green. In the **Download Firmware** dialog box, the message shows the file your printer is downloading, and the progress bar indicates the progress of downloading.

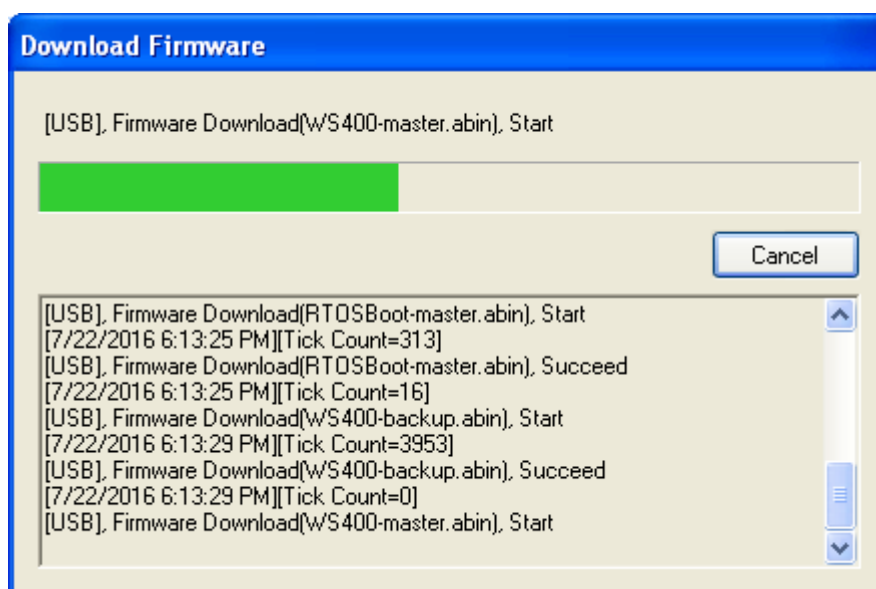

- When the data transmission is complete, your printer starts to update its firmware. During the update LED 2 turns to red and orange alternatively, while LED 1 turns to solid green. In the **Download Firmware** dialog box, the message shows that your printer is updating the firmware.

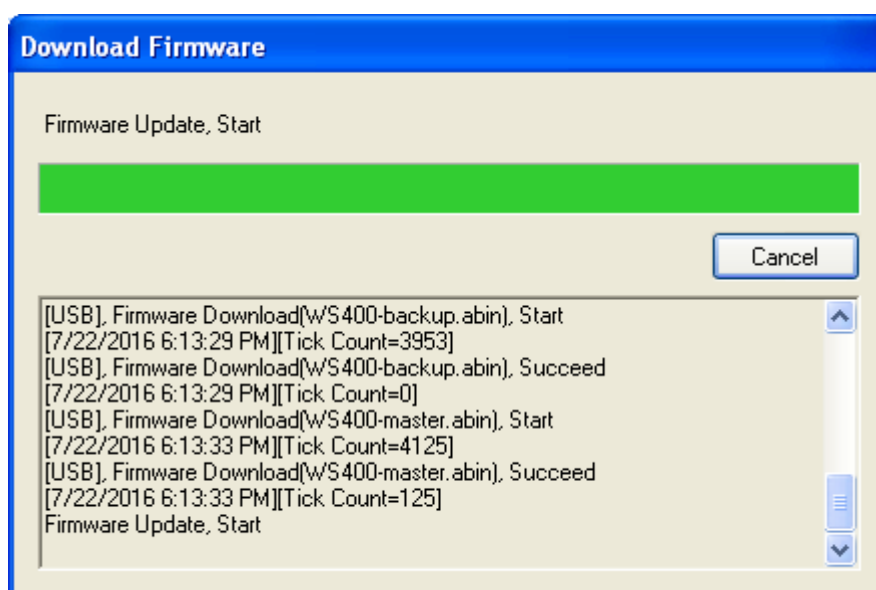

11. Printer will restart automatically after the message “Firmware Update, Succeed” appears.

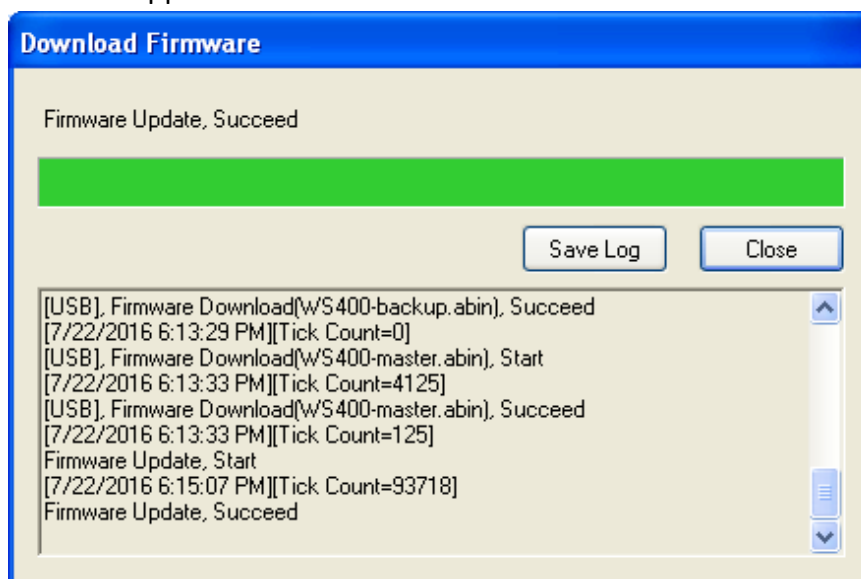

12. When the update is complete, the message “Firmware Update Complete” appears. Click **Close** to close the dialog box, or click **Save Log** to save the firmware update log.

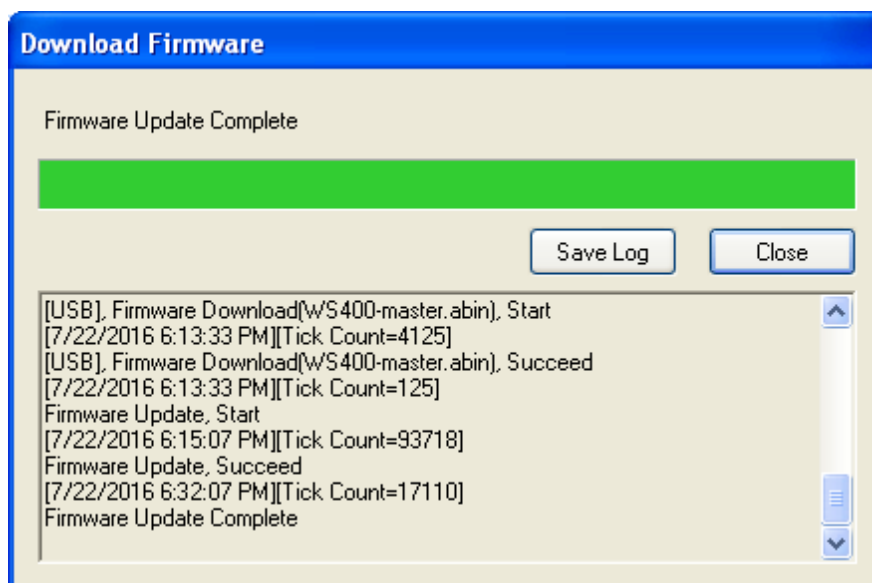

Note Sometimes you'll find LED 2 keeps turning to red and orange alternatively after the message “Done” appears. It means your printer is updating the other copy of firmware. There are two copies of firmware stored in your printer: master and backup. They are used to restore each other in case the firmware is lost or corrupted. By default, the master is the primary copy. Your printer uses the backup if the master doesn't work.

6.3.2 Update via the LAN or Multi-LAN port

Before you update the firmware via the **LAN** or **Multi-LAN** port, you need to set up a network connection. For details, see [Set up LAN connection](#), [Set up IPv6 connection](#) and [Set up WLAN connection](#).

1. Connect your printer and computer to a network device (hub, switch or router) with Ethernet cables.
2. Make sure the print module is closed.
3. Turn on your printer, and start SATO WS2 Printer Utility.
4. In the **Input/Output Port** list, click **LAN** or **Multi-LAN**, and do one of the following:
 - If you are using the **LAN** port, the **Port Name** and **Port Information** will show the LAN settings after you set up a network connection.

LAN



IPv6

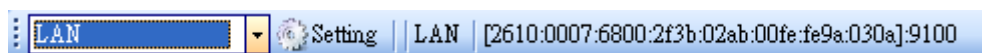

WLAN



- If you are using the **Multi-LAN** port, click **Setting**. In the **Setting Multi-LAN** dialog box, in the **IP Address** box, enter your printer's IP address and click **Add**. If you want to update the firmware of multiple printers, keep adding their IP addresses, and then click **OK**.

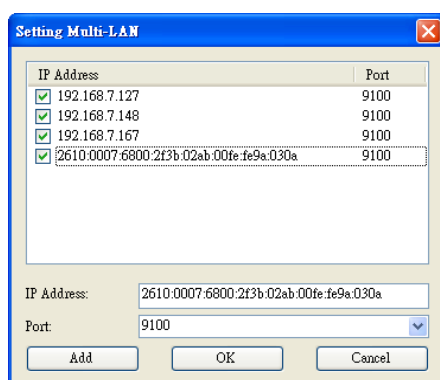

6 Set Up Interface Connection by SATO WS2 Printer Utility

5. In the **Navigation** pane, click **Download**, and click the **Firmware** tab.

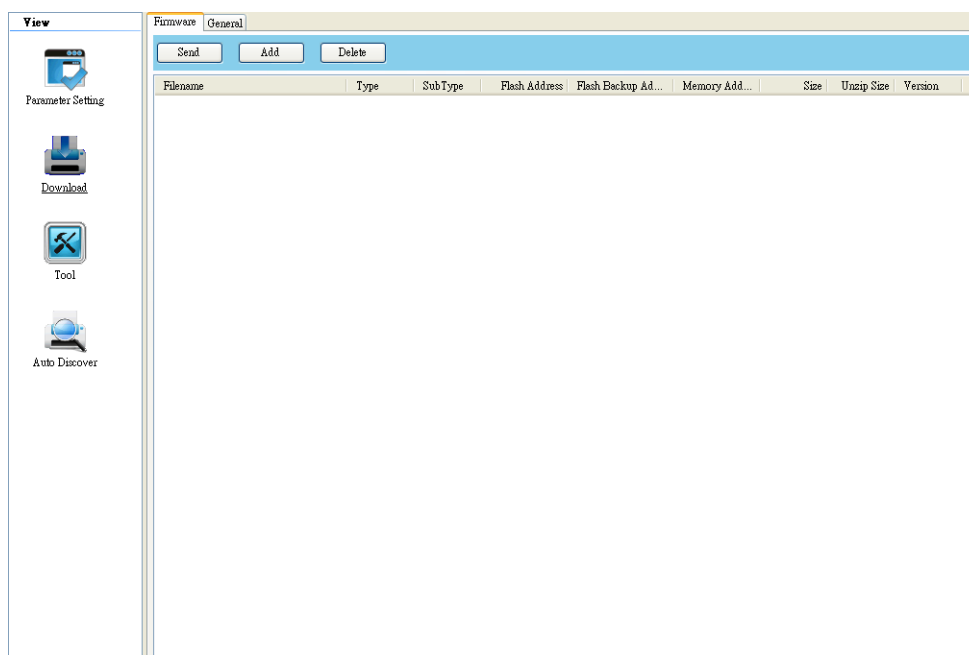

6. Right-click in the blank area and click **Add**.

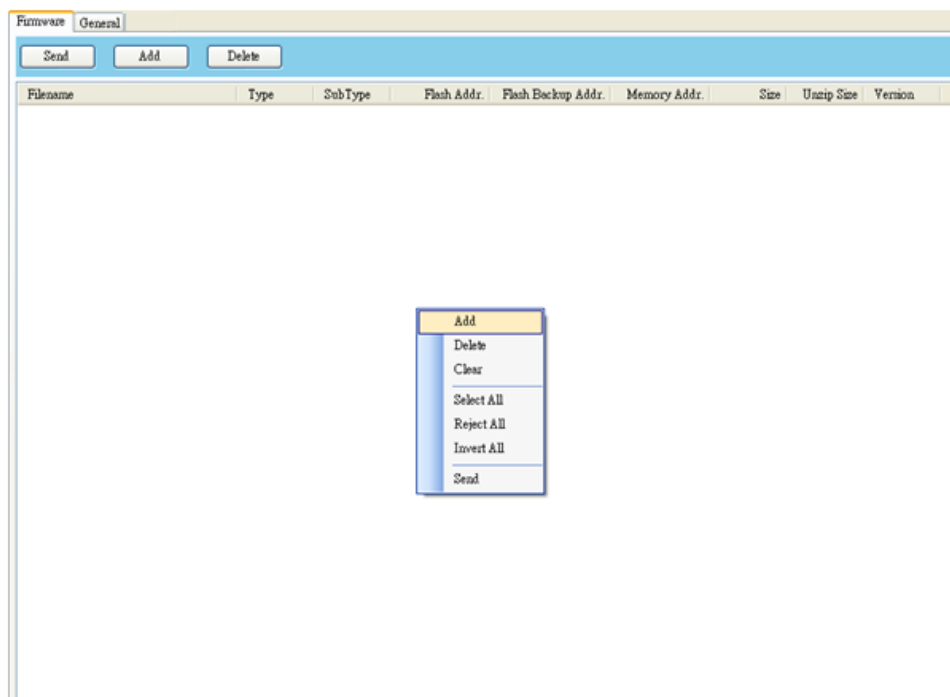

6 Set Up Interface Connection by SATO WS2 Printer Utility

7. In the **Open** dialog box, browse to the folder that contains the firmware files. Select all of them and click **Open**.

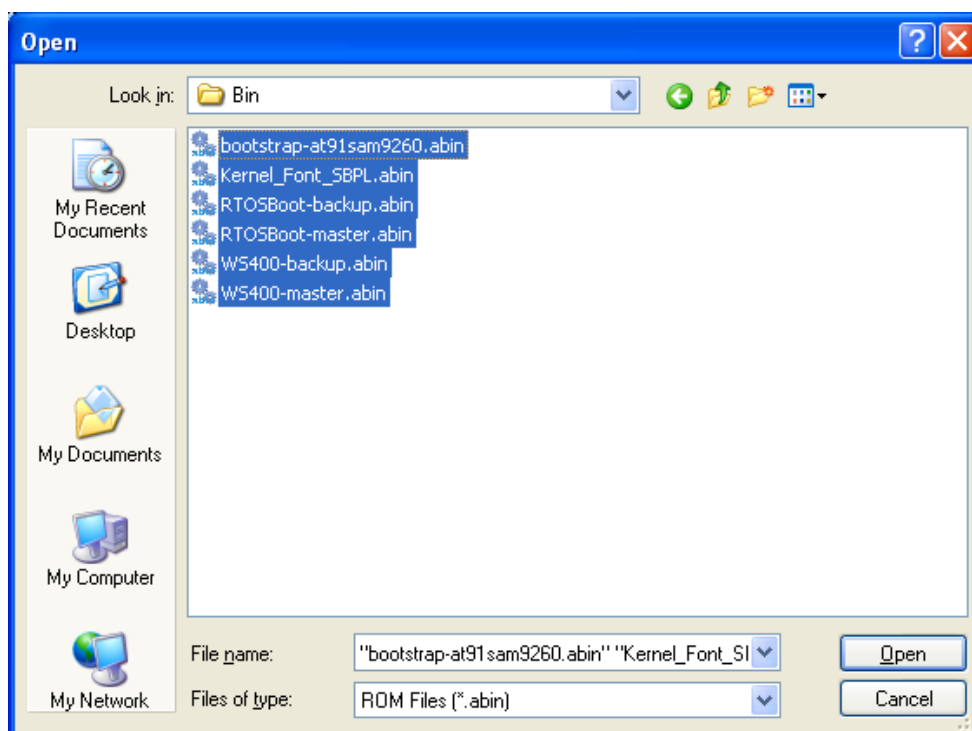

8. If you want to update specific files, select the check boxes of those files; if you want to update all of the firmware files, right-click in the blank area in the list, and click **Select All**.

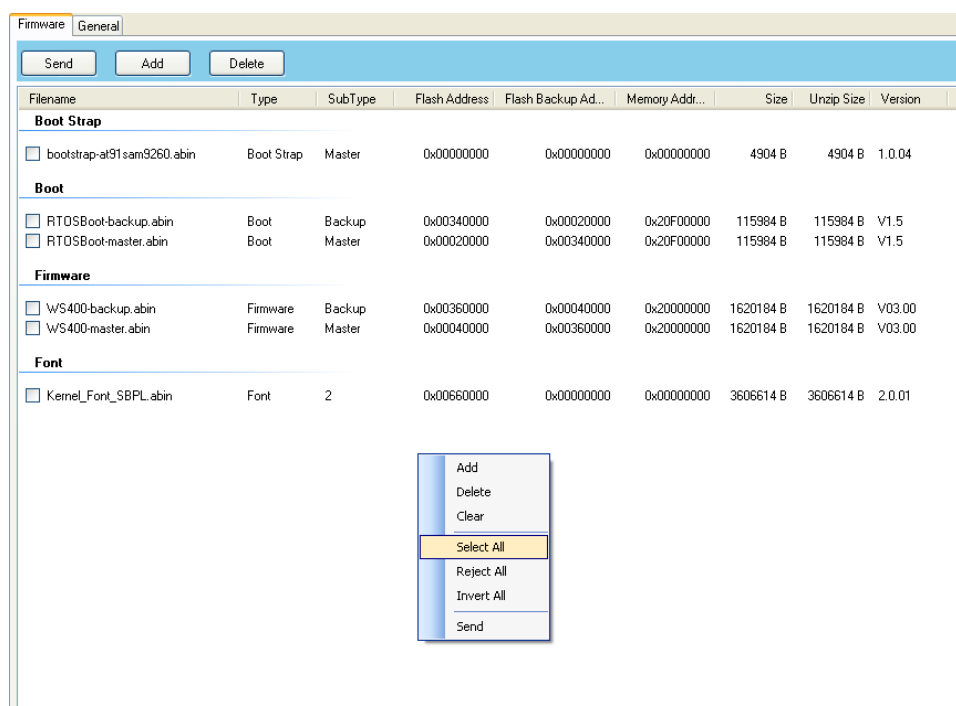

- Click **Send** to send the firmware files to your printer. During the transmission LED 1 blinks green. In the **Download Firmware** dialog box, the message shows the file your printer is downloading, and the progress bar indicates the progress of downloading.

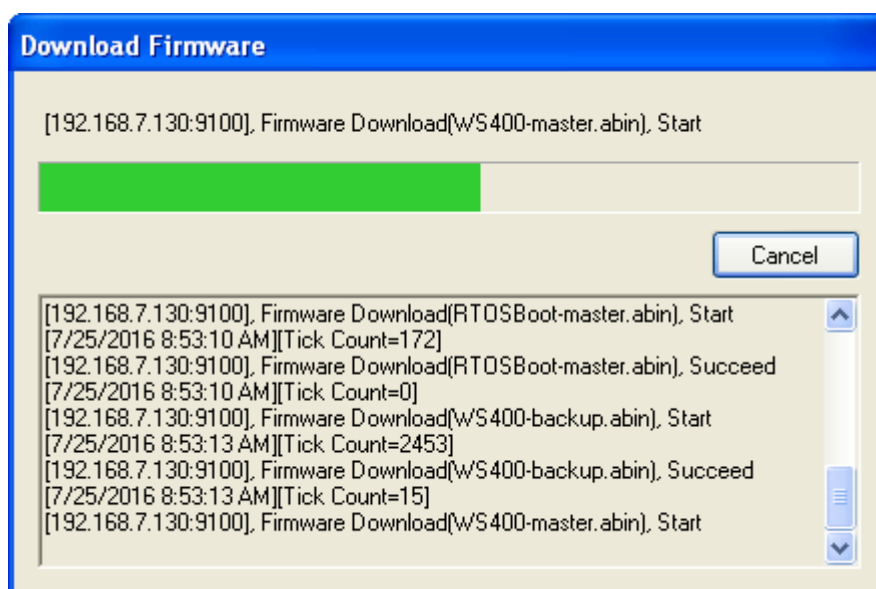

- When the data transmission is complete, your printer starts to update its firmware. During the update LED 2 turns to red and orange alternatively, while LED 1 turns to solid green. In the **Download Firmware** dialog box, the message shows that your printer is updating the firmware.

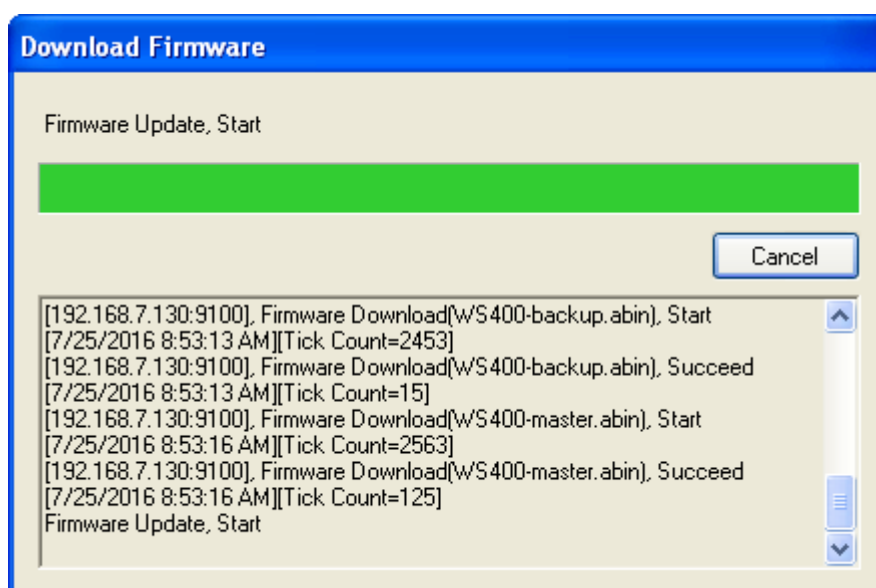

11. Printer will restart automatically after the message “Firmware Update, Succeed” appears.

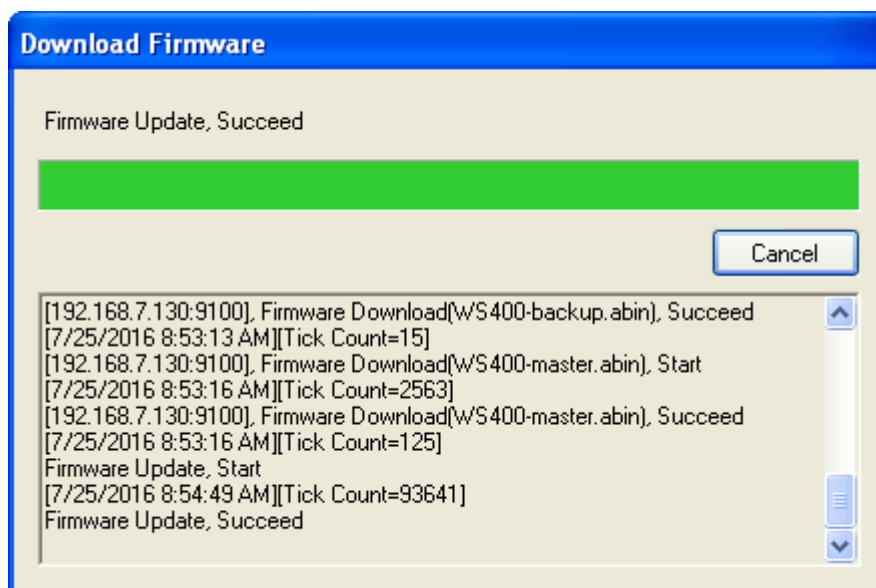

12. When the update is complete, the message “Firmware Update Complete” appears. At the same time, your printer restarts itself. Click **Close** to close the dialog box, or click **Save Log** to save the firmware update log.

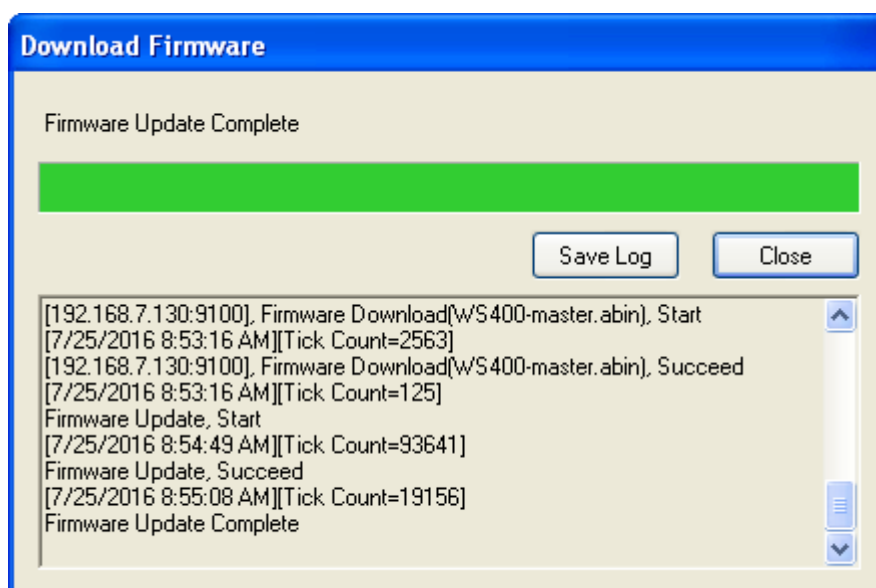

6.4 Update firmware via the USB host

The USB host is a USB type A port for a USB flash drive, which can be used to quickly update the firmware.

1. Create a folder named “Firmware” in your USB flash drive, and copy the firmware files to it. The file “WS2-master.abin” needs to be in the folder.
Note The firmware file may have different name as you get it.
2. Make sure the print module is closed, and turn off your printer.
3. Turn ON the printer power (or reboot the printer) after insert your USB flash drive to the printer. The printer starts to update the firmware.
Note You cannot update firmware even if insert your USB flash drive to the printer after turn ON the printer power (or reboot the printer).
4. During the update LED 2 blinks green a few times, and turns to red and orange alternatively. When the update is complete, LED 2 goes out.



Caution Do not remove the USB flash drive during the update.

6.5 Update firmware in Atmel mode

Service man only

Typically, firmware can be updated in SATO WS2 Printer Utility without problems, but there are rare cases SATO WS2 Printer Utility cannot handle. If any unexpected conditions keep you from update firmware in SATO WS2 Printer Utility, you need to update it in Atmel mode.

Step 1. Enter Atmel mode

This part describes how to enter Atmel mode.

1. Turn off your printer.
2. Turn over your printer.
3. Loosen and remove three screws from the base.
4. Lift the base and unplug all the cables.
5. Locate the DIP switch on the main board. Set Switch 1 and 2 to the **OFF** position (down).



Step 2. Update your firmware

This part describes how to update your firmware in Atmel mode.

1. Plug all the cables back into the main board.
2. Turn on your printer. Both LEDs won't glow. This is normal.
3. Start SATO WS2 Printer Utility. In the **Navigation** pane, click **Download**, and click the **Firmware** tab.

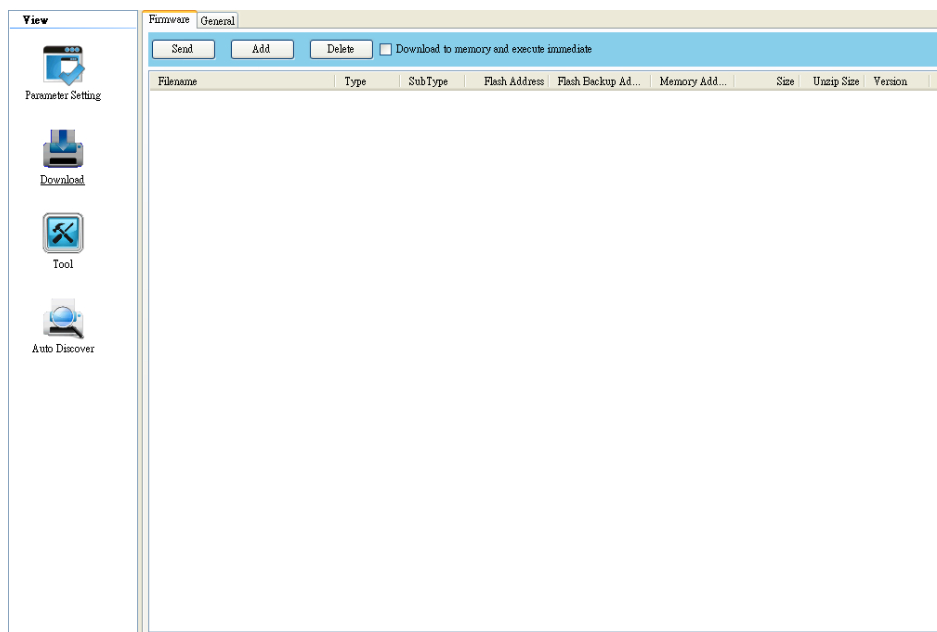

4. Right-click in the blank area and click **Add**.

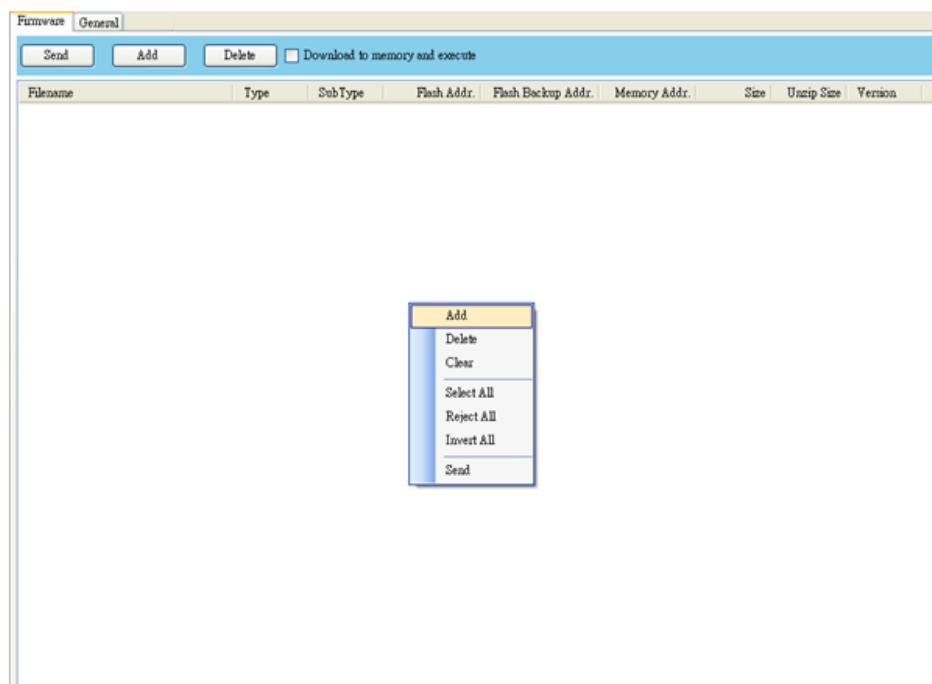

6 Set Up Interface Connection by SATO WS2 Printer Utility

5. In the **Open** dialog box, browse to the folder that contains WS2 firmware files. Select all of them and click **Open**.

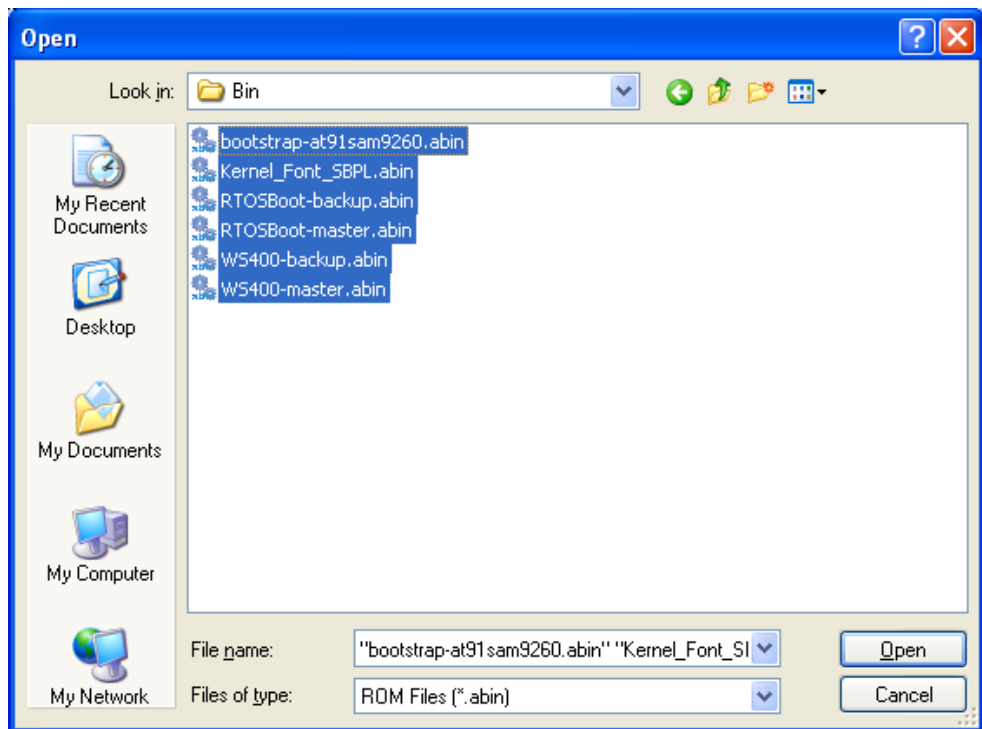

6. Right-click in the blank area in the list, and click **Select All** to select all of the check boxes.

Note If you want to execute a firmware file without saving it into the flash memory, select the **Download to memory and execute** check box and click **Send**.

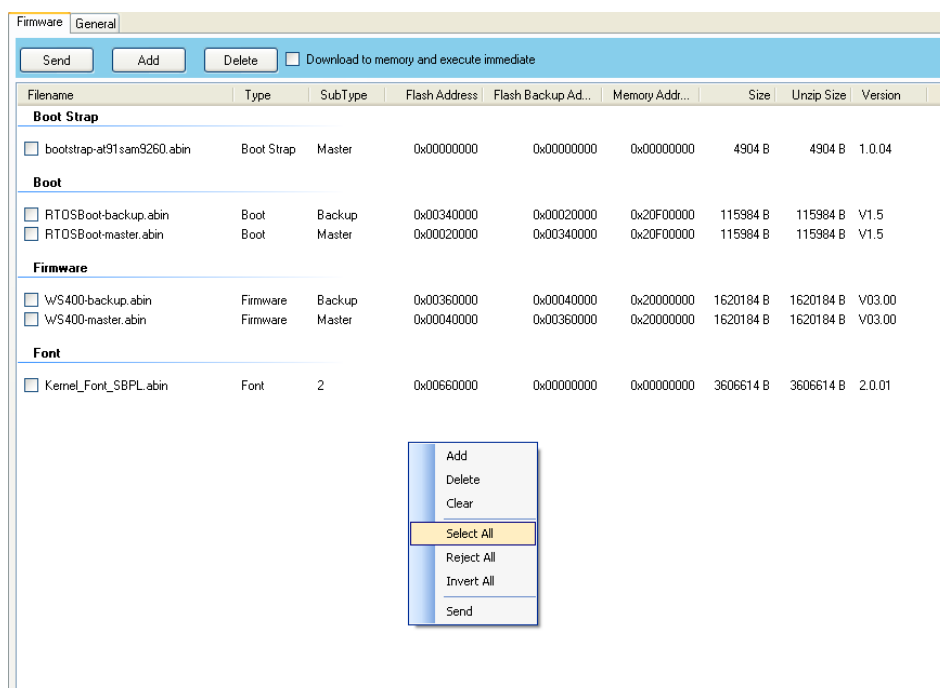

7. Click **Send** to send the firmware files to your printer. When the update is complete, the message “Done” appears. Click **Close** to close the dialog box, or click **Save Log** to save the firmware update log.

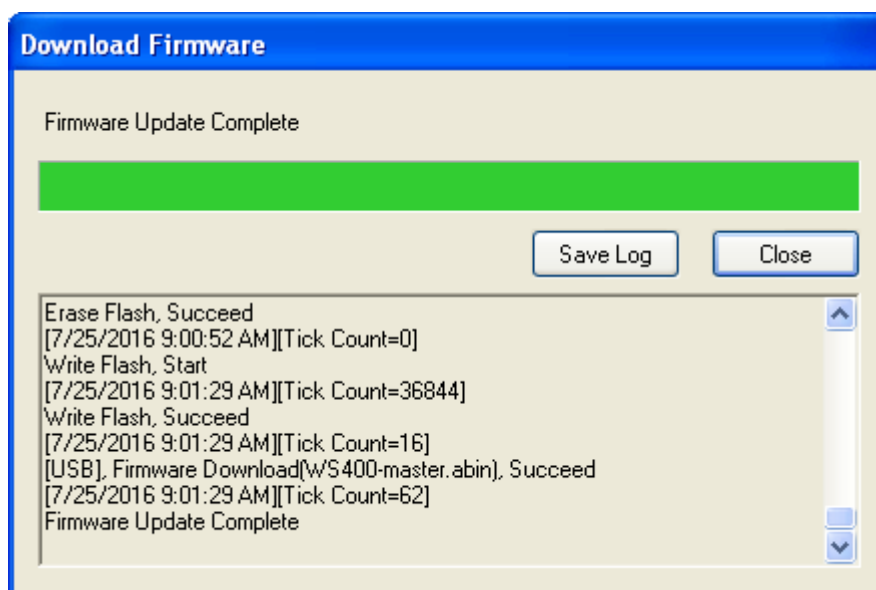

Step 3. Exit Atmel mode

This part describes how to exit Atmel mode.

1. Turn off your printer.
2. Set **DIP Switch 1** and **2** to the **ON** position (up). If it's inconvenient to set **DIP Switch** while cables are connected, unplug all the cables to do this.



3. Reinstall the base and the secure it with three screws.
4. Turn over your printer.
5. Turn on your printer.

7 Specifications

This chapter provides specifications for the printer. Specifications are subject to change without notice.

7.1 Printer

Model	WS208	WS212
Print method	Direct Thermal	
Resolution	203 dpi (8 dots/mm)	300 dpi (12 dots/mm)
Media Alignment	Centered	
Operation Mode	Standard: Continuous mode , Tear-off mode Optional: Cutter mode , Peeler mode	
Sensor	Reflective Sensor (Movable) Media Transmissive sensor x 1 (fixed, 6.27mm offset)	
	Head Open Switch	
Operation interface	LED indicator x 2, Button x 1	
Print Speed	2, 3, 4, 5, 6, 7 inches/sec (50.8, 76.2, 101.6, 127, 152.4, 177.8 mm/sec) 2 & 3ips for peel off mode	2, 3, 4, 5 inches/sec (50.8, 76.2, 101.6, 127 mm/sec) 2 & 3ips for peel off mode
Printable Area	Max. length 100"(2540mm)	Max. length 50"(1270mm)
Printing Width	Max. 54.1mm	Max. 56.8mm
Print Ratio	Average print ratio within 15 % or less (whole print layout area) Full width with 1mm pitch is required	
Interface	USB hosts(Type A), USB device(Type B) , Ethernet	
Programming Language	SDPL+SEPL+SZPL	
Accessories	Peeler, Full Cutter	
On-Board Memory	Standard Memory (Flash ROM): 16 MB User Memory: 8 MB Standard Memory (SDRAM): 32 MB USB storage up to 32 GB (FAT32 format only)	
CPU Type	32 bit RISC microprocessor	

Software---Label editing	Windows Driver (Windows Vista/ Win 7/ Win 8/ Win 10), BarTender® from Seagull Scientific, Nice Label
Software--- Utility	Printer Tool
Agency Listing	CB, CE, FCC, RCM, CB, cTUVus

7.2 Media

Properties	Description
Media Size	Max. width: 60mm, Min. width: 12mm Max length 100" (2540 mm), Min length 0.4" (10mm) Thickness: 0.00236"~0.00787" (0.06mm~0.2mm) 5"(127mm) OD on a 1"/1.5" (25.4/38 mm) ID core 4.5"(115mm) OD on a 0.5" (12.7mm) ID core Min. width: 12mm for partial cutter options. Min. length: 25mm for cutter and peeler options.
Media Type	Direct Thermal Label Direct Thermal Tag Roll Paper (Inside Wound or Outside Wound) Fanfold Paper

7.3 Electrical and operating environment

Properties	Range
Power Supply	Voltage: AC 100 V ~ 240 V ± 10 % (full range) Frequency: 50 Hz - 60 Hz ± 5 %
Temperature	Operating: 41°F~104°F(5 °C ~ 40 °C) Storage: -4°F~140°F(-20 °C ~ 60 °C)
Humidity	Operating: 25 %RH ~ 85 %RH (non-condensing) Storage: 10 %RH ~ 90 %RH (non-condensing)

7.4 Physical dimension

Dimension	Size and Weight
Size	W 116 mm x H 170 mm x D 215 mm
Weight	1.05 kg (excluding media and accessories)

7.5 Fonts, Barcodes, and Graphics

The specifications of fonts, bar codes and graphics depends on the printer emulation.

The emulations SDPL, SEPL, and SZPL are printer programming languages, through which the host can communicate with your printer.

Printer Programming Language SDPL

Programming Language	SDPL
Internal fonts	9 fonts with different point size 6 fonts with ASD smooth font. Courier font with different symbol sets.
Symbol sets (Code pages)	Courier font symbol set: Roman-8, ECMA-94, PC, PC-A, PC-B, Legal, and PC437 (Greek), Russian.
Soft fonts	Downloadable soft fonts by Print Tool
Font size	1x1 to 24x24 times
Character rotation	0, 90, 180, 270 degree, 4 direction rotation
Graphics	PCX, BMP, IMG, GDI and HEX format files
1D Barcodes	Codabar、Code 128 subset A/B/C、Code 39、Code 93、EAN-13、EAN-8、GS1 Data bar (RSS) 、Interleaved 2 of 5 (Standard/with modulo 10 checksum/ with human readable check digit/ with modulo 10 checksum & shipping bearer bars) 、Plessey、Postnet、UCC/EAN-128、UCC/EAN-128 K-MART、UCC/EAN-128 Random weight、UPC2、UPC5、UPC-A、UPC-E、FIM、HBIC、Telepen
2D Barcodes	PDF417, Micro PDF, Maxi Code, GS1 Data Matrix, Data Matrix (ECC200), QR Code, Composite Symbologies, Aztec

Printer Programming Language SEPL

Programming Language	SEPL
Internal fonts	5 fonts with different point size
Symbol sets (Code pages)	8 bits code page : 437, 850, 852, 860, 863, 865, 857, 861, 862, 855, 866, 737, 851, 869, 1252, 1250, 1251, 1253, 1254, 1255 7 bits code page: USA, BRITISH, GERMAN, FRENCH, DANISH, ITALIAN, SPANISH, SWEDISH and SWISS
Soft fonts	Downloadable soft fonts by Print Tool
Font size	1x1 to 24x24 times
Character rotation	0, 90, 180, 270 degree, 4 direction rotation
Graphics	PCX , Binary Raster, BMP and GDI
1D Barcodes	Codabar、Code128 subset A/B/C、Code 128 auto、Code 128 UCC (shipping container code)、Code 39、Code 39 with check sum digit 、Code 93、EAN-13、EAN-13 2/5 digit add-on、EAN-8 (Standard, 2 /5digit add-on) 、 GS1 Data bar (RSS) 、 Interleave 2 of 5、Interleaved 2 of 5 with check sum、Interleaved 2 of 5 with human readable check digit、Matrix 2 of 5、Postnet 、 UCC/EAN code 128 (GS1-128) 、UPC-Interleaved 2 of 5、UPC-A、UPCA 2/5 digit add-on、UPC-E、UPCE 2/5 digit add-on、German Postcode
2D Barcodes	PDF417, Micro PDF, Maxi Code, GS1 Data Matrix, Data Matrix (ECC200), QR Code, Composite Symbologies, Aztec

Printer Programming Language SZPL

Programming Language	SZPL
Internal fonts	8 (A~H) fonts with different point size. 8 AGFA fonts: 7 (P~V) fonts with fixed different point size (not scalable). 1 (O) font with scaling point size. CG Triumvirate Bold Internal TTF font.
Symbol sets (Code pages)	USA1, USA2, UK, HOLLAND, DENMARK/NORWAY, SWEDEN/FINLAND, GERMAN, FRANCE1, FRANCE2, ITALY, SPAIN, MISC, JAPAN, IBM850, Multibyte Asian Encodings, UTF-8, UTF-16 Big-Endian, UTF-16 Little-Endian, Code page 1250, 1251, 1252, 1253, 1254
Soft fonts	Downloadable soft fonts by Print Tool
Font size	1x1 to 10x10
Character rotation	0, 90, 180, 270 degree, 4 direction rotation
Graphics	GRF, Hex and GDI
1D Barcodes	Codabar、 Code 11、 Code128 subset A/B/C、 Code39、 Code 39 with check sum digit、 Code 93、 EAN-13、 EAN-8、 GS1 Data bar (RSS)、 Industrial 2 of 5、 Interleave 2 of 5、 Interleaved 2 of 5 with check sum、 Interleaved 2 of 5 with human readable check digit、 MSI、 Plessey、 Postnet、 UPC-A、 UPC-E、 Logmars 、 Standard 2 of 5
2D Barcodes	PDF417, Micro PDF, Maxi Code, GS1 Data Matrix, Data Matrix (ECC200), QR Code, Composite Symbologies, Aztec

7.6 Ethernet

Properties	Description
Port	RJ-45
Speed	10Base-T/100Base-T (Auto Detecting)
Protocol	ARP, IP, ICMP, UDP, TCP, HTTP, DHCP, Socket, LPR, IPv4, IPV6, SNMPv2
Mode	TCP Server/Client, UDP Client
Technology	HP Auto-MDIX, Auto-Negotiation

7.7 Wireless LAN (Option)

Properties		Wireless LAN I/F		
Hardware	Protocol	IEEE802.11b/g/n		
	Enabled Device	WS2 Series		
	Destination	USA	Europe	
	Frequency (Center Channel)	2412 ~ 2462 MHz	2412 ~ 2472 MHz	
	Channel	1 ~ 11 ch	1 ~ 13 ch	
	Spacing	5 MHz		
	Transmission Speed/Modulation	IEEE 802.11b	Transmission Method	Conforming to IEEE 802.11b DSSS method
			Channel	Depending on the country
			Data Transmission Speed/Modulation	11/5.5 Mbps: CCK 2 Mbps: DQPSK 1 Mbps: DBPSK
	Transmission Speed/Modulation	IEEE 802.11g	Transmission Method	Conforming to IEEE 802.11g OFDM method DSSS method
Channel			Depending on the country	
Data Transmission Speed/Modulation			54/48 Mbps: 64 QAM 36/24 Mbps: 16 QAM 18/12 Mbps: QPSK 9/6 Mbps: BPSK	
Transmission Speed/Modulation	IEEE 802.11n	Transmission Method	Conforming to IEEE802.11n OFDM method	

Properties		Wireless LAN I/F		
			Channel	US)1-11ch (JP/DE)1-13ch
			Data Transmission Speed/Modulation	20MHz : 6.5M / 7.2M / 13M / 14.4M / 19.5M / 21.7M / 26M /28.9M / 39M / 43.3M / 52M / 57.8M / 58.5M / 65M / 72.2M(Auto-sensing)
	Antenna	External antenna		
	Aerial power	802.11b	Max +15 dBm	
		802.11g	Max +17 dBm	
		802.11n	Max +17 dBm	
Software	Connection mode	Infrastructure, Adhoc		
	Default IP Address	192.168.1.1		
	Default Subnet Mask	255.255.255.0		
	Default ESSID	SATO_PRINTER		
	Default DHCP	Enable		
	Security	IEEE 802.11i		
	Cryptography	WEP (64/128bit), TKIP (WPA), AES (WPA2)		
	Authorization	Shared Key, Open System, PSK, PEAP, TLS,TTLS, LEAP, EAP-FAST		
	Protocol	TCP/IP, Socket, LPD (LPR) , DHCP		
	Wireless LAN Parameter and Status Monitor	Parameter: Command (Printer Utility)		

7.8 Bluetooth (Option)

Properties	Bluetooth I/F
Standard	Bluetooth 4.2
Enable device	WS2 Series
Connection Form	Only one-to-one connection is supported.
Support Profile / Function	GAP, SDP, SPP and GATT profiles
Class of radio transmission	CLASS 2
Transmission method	Bi-directional (Half-duplex)
Flow Control	Credit based flow control
Operating mode	Slave Mode
Transmission Distance	10m without obstacles (360 degrees)
RF Frequency Range	2402 ~ 2480MHz
Class 2 output power	+1.5 dBm (typical)
Applicable countries	FCC,CE, IC

※ Please check with your local SATO sales representative, whether Bluetooth option is available in your region.

7.9 Ports

This section provides information about IO port specifications for the printer.

7.9.1 USB

There are two common USB connectors. Typically, type A is found on hosts and hubs; type B is found on devices and hubs. The figure below shows their pinouts.

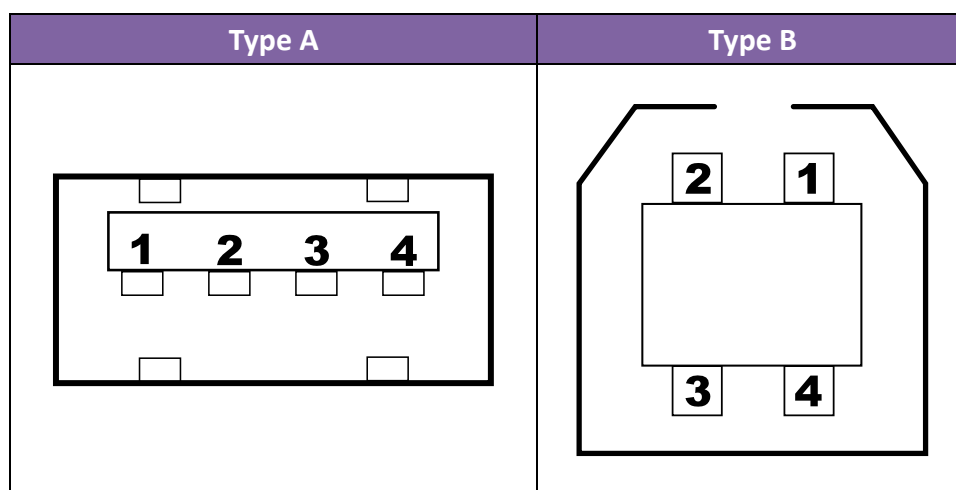

Pin	Signal	Description
1	VBUS	+5V
2	D-	Differential data signaling pair -
3	D+	Differential data signaling pair +
4	Ground	Ground

7.9.2 Ethernet

The Ethernet uses RJ-45 cable, which is 8P8C (8-Position 8-Contact). The figure below shows its pinout.

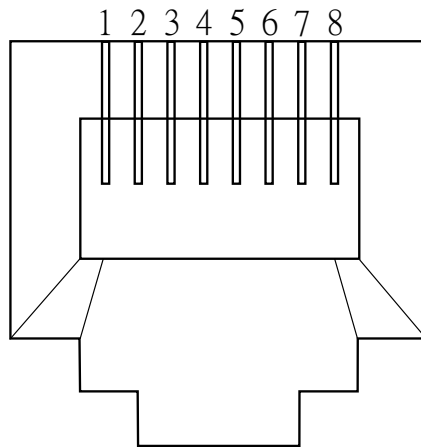

Pin	Signal
1	Transmit+
2	Transmit-
3	Receive+
4	Reserved
5	Reserved
6	Receive-
7	Reserved
8	Reserved