

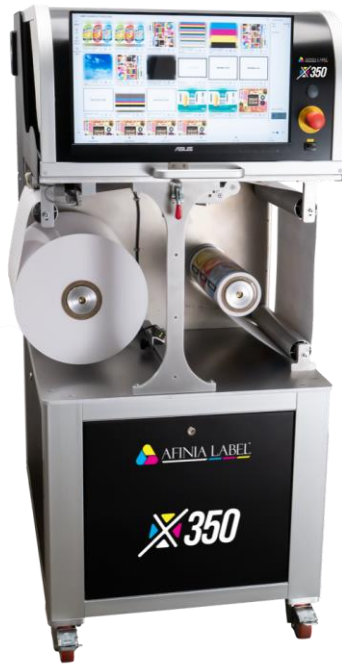

# AFINIA LABEL<sup>®</sup>

## X350



## X350 User manual

v1.3

Click here for more information!



**IPSi**

**INTEGRATED  
PRODUCTIVITY  
SYSTEMS**

(844) 477-4911 | [www.ipsiscan.com](http://www.ipsiscan.com)

© 2023 Afinia Label. All content is the confidential property of - or licensed to – Afinia Label (“Afinia,” “we,” or “us”) and is protected under Italian, EU and Foreign copyright, trademark and other intellectual property laws.

Confidential and disclosed in accordance with the disclaimer on this document’s final page.

© 2023 Afinia Label. This document, attachments, and information contained herein are the confidential and proprietary property of Afinia Label. and their suppliers. As such, this document, attached files, and information contained herein are subject to all non-disclosure and proprietary information agreements currently in effect with your organization. Copies of this document, any portion of this document, or attachments may not be transmitted or disclosed to any third party without the prior written permission of Afinia Label.

### Copyright

© 2023 Afinia Label – 8150 Mallory Court Chanhassen, MN 55317

## Contents

<b>Compliance and Documentation</b>	<b>5</b>
DECLARATION OF CONFORMITY	5
ATTACHED DOCUMENTS	5
AUTHORIZED ASSISTANCE	5
ABOUT THIS MANUAL	5
PICTOGRAMS	7
<b>Product information and safety</b>	<b>8</b>
WARRANTY	8
SAFETY AND DOCUMENTATION COMPLIANCE	9
INTRODUCTION	10
SAFETY REGULATIONS	10
GENERAL DESCRIPTION	10
TECHNICAL DATA	11
NOISE	11
IDENTIFICATION PLATE	11
SYSTEM COMPONENTS	12
FEASIBLE OPERATIONS	13
INTENDED AND UNINTENDED USE OF THE MACHINE	13
INTENDED USE	13
UNINTENDED USE	13
RESIDUAL RISKS	14
FIRST AID	17
<b>Handling and configuration</b>	<b>18</b>
RECEIVING THE X350	18
DETAILED EXAMINATION CHECKLIST	18
INCLUDED ITEMS	18
MACHINE WEIGHT	18
MACHINE MOVEMENT	18
SUBSEQUENT MOVEMENTS	19
MANUAL HANDLING	19
MECHANICAL HANDLING	20
UNCRATING X350	22
SUPPORTED ENVIRONMENTAL CONDITIONS	44

WARNING	44
LIGHTING CONDITIONS	44
ELECTRICAL CONNECTION GUIDELINES	44
<b>Loading material</b>	<b>45</b>
GAP AND BLACK MARK MEDIA SPECIFICATIONS	48
<b>Submitting a print job</b>	<b>49</b>
RIPPING IMAGE	49
PRINTING IMAGE	51
<b>User Interface</b>	<b>53</b>
DASHBOARD	53
1. PRINT MODULE STATUS INFORMATION.	53
2. INK CARTRIDGE INFORMATION	54
3. UNWINDER/REWINDER AND WEB SPEED INFORMATION	54
4. QUICK-ACTION BUTTONS E.G., SPEED CHANGE, ERROR, AND WARNING INFO	54
5. JOB QUEUE	54
6. JOB QUEUE CONTROL BUTTONS	55
7. GENERIC STATISTICS	55
8. PAGE SELECTOR	55
JOB LIBRARY	56
1. SELECTED FOLDER INDICATOR	56
2. FOLDER SELECTOR	57
3. FOLDER INFO SECTION	57
4. JOB ORGANIZER AND SELECTOR OPTIONS	57
5. JOB INFO SECTION	58
6. JOB OPERATIONS	58
7. JOB COMMAND SECTION	58
JOB EDITOR	58
1. GENERIC JOB INFORMATION	59
2. JOB CONSUMPTION DATA	59
MAINTENANCE	59
SIGNING IN	60
PRINT ENGINE	60
PLC	62
STATISTICS	64

---

SYSTEM INFORMATION	64
SETTINGS	65
SUPPORT VIDEOS	72
SESSIONS	72
SETTINGS	72
QUICKRIP	73
UPLOAD & SOURCE FILES	74
PREVIEW AND LIVE VIEW	75
OUTPUT CONFIGURATIONS, PRINT CONTROL AND SETTINGS	76
SETTINGS	80
<b>Operations</b>	<b>83</b>
START OF DAY OR SHIFT	83
END OF DAY OR SHIFT	83
PRINthead PRIME CONFIRMATION	83
CAP THE PRINthead	84
SHUT DOWN THE PRINTER	84
PEN-TO-PAPER SPACING (PPS) OPERATIONS	84
PPS REGULATION	85
QUICK RELEASE OF THE SPITTOON ASSEMBLY	87
<b>Inspection Tasks and Frequency</b>	<b>90</b>
<b>Changing consumables</b>	<b>90</b>
INSTALL THE WIPER CARTRIDGE	90
INSTALLING THE INK CARTRIDGES	92
INSTALLING THE PRINthead	93
PRINthead INSERTION TROUBLESHOOTING	99
<b>Printhead maintenance</b>	<b>102</b>
<b>Fork sensor</b>	<b>103</b>
SENSOR ADJUSTMENT	103
SIMPLE AUTO-ADJUSTMENT	103
FINE AUTO-ADJUSTMENT	103
ALARM SIGNAL	103
LIGHT/DARK WORKING MODE	104
ALTERNATE READING MODE	104

# COMPLIANCE AND DOCUMENTATION

## Declaration of conformity

The X350 is supplied with a Declaration of Conformity, as provided in adherence to prevailing European regulatory requirements. Please refer to the attached documentation for further details.

---



### NOTE

Before starting to use the product in any forms, verify the presence of all the listed documents.

---



### NOTE

If the product is sold to third party, all documentation must be delivered together with it.

---

## Attached documents

Attached documents:

- This manual.

## Authorized assistance

Technical assistance for the product can only be provided by the manufacturer or by a technician authorized and appointed by the manufacturer.

## About this manual

---



### NOTE

Upon receiving the machine, it is imperative to carefully review the user and maintenance manuals before proceeding with any operational tasks.

---

---

This manual provides comprehensive instructions for the operation and maintenance of the X350. It is structured into various sections, each addressing specific topics, further organized into chapters and paragraphs. The comprehensive index offers a quick reference to all subjects covered within the manual.

Page numbers are sequentially numbered and appear on each page. This manual is intended for individuals responsible for the operation and maintenance of the X350, encompassing its technical lifespan beyond production, during use, and potential resale.

Should the machine be transferred to third parties for any reason, including sale or temporary use, it is imperative that the X350 machine be provided with all associated documentation.

### **User Responsibility and Disclaimer**

The information contained within this manual serves as a guide and should not replace the knowledge and experience held by the user. Users bear sole responsibility for using the X350 machine as intended.

Prior to initiating any operation on any component, it is essential to thoroughly read the entire manual and focus on the section corresponding to the operation planned.

### **Confidentiality**

This manual contains confidential proprietary information and may not, in any form or extent, be disclosed to third parties without the prior written consent of Afinia Label.

### **Manufacturer's Declaration**

The manufacturer affirms that the information contained within this manual aligns with the technical and safety specifications of the product referenced in the manual.

A certified copy of this manual is retained in the technical records of the product, maintained at the premises of Afinia Label.

Afinia Label exclusively recognizes documentation produced, authorized, or distributed by itself or its authorized representatives.

### **Document Retention and Compliance**

This manual, along with the complete technical file, will be retained by the manufacturer for the duration mandated by relevant regulations.

During this period, a copy of the accompanying documentation may be requested at the time of sale.

The entire technical file remains accessible throughout this period, exclusively for regulatory authorities that may request a copy.

After this period, the responsibility lies with the product's custodians to ensure both the product and documentation comply with prevailing regulations at the time of inspection.

### Pictograms

The following pictograms are displayed on the machine:

1. **Prohibitions:** These pictograms indicate actions or conditions that are prohibited or not allowed. They serve as visual warnings to prevent users from engaging in specific activities or behaviors that could be harmful or result in damage to the machine or pose a safety risk.



Do not touch.



Do not extinguish with water

2. **Dangers:** These pictograms signify potential hazards or dangers associated with the machine. They alert users to specific risks and dangers they should be aware of while operating or interacting with the machine. These warnings are essential for safety and should be heeded to prevent accidents or injuries.



Generic danger



Electricity hazard



Crushing of hands



Moving parts



# PRODUCT INFORMATION AND SAFETY

## Warranty

The warranty for the X350 is contingent on specific conditions and is further detailed in the purchase contract. It remains valid exclusively when the machine is operated within its intended use parameters. Any alterations or repairs made by unauthorized parties, excluding routine and extraordinary maintenance procedures outlined in the "MAINTENANCE" section, will render the warranty null and void.

It is crucial to note that the warranty will not cover damages resulting from user incompetence or negligence during machine operation or because of inadequate or omitted maintenance practices.

The warranty terms for our products are outlined as follows:

1. The warranty period is twelve (12) months.
2. The manufacturer will decide to replace malfunctioning or incorrectly manufactured parts after careful inspection and verification of poor construction.
3. The buyer is responsible for all transportation and shipping costs if the warranty terms are not met.
4. Replaced components during the warranty period become the property of the manufacturer.
5. Only the original purchaser who has adhered to the standard maintenance instructions provided in the manual is eligible for this warranty. Our warranty coverage expires when ownership of the machine is transferred to a new owner or if modifications are made to the machine.
6. The warranty does not cover damage resulting from excessive stress, such as continuing to use the machine after detecting an anomaly, employing inappropriate operating methods, or failing to follow the instructions for use and maintenance.
7. The manufacturer assumes no responsibility for any difficulties that may arise in resale or use abroad due to the regulations in effect in the country where the machine was originally sold.
8. The machine or the defective part must be returned to the manufacturer for replacement; otherwise, the cost of the replaced part will be borne by the buyer.
9. If necessary, the machine should be sent to the manufacturer or an authorized repair center designated by the manufacturer for repair or replacement; otherwise, the warranty will not be honored.

**Notice:** If you find it necessary to utilize the warranty, kindly provide the following information and complete the technical assistance form:

- Type: Specify the type or model of the product.
- Date of Purchase: Please present the purchase document as proof of the purchase date.

- Detailed Description of the Problem: Clearly describe the issue or problem you are experiencing with the product. This detailed description will assist in expediting the warranty process and ensuring efficient technical assistance.

---

### NOTE



Failure to adhere to the prescribed intervention and usage methods of the machine as outlined in its documentation will lead to the forfeiture of the warranty terms.

---

The warranty does not cover machine downtime, lack of use, etc.

### Safety and Documentation Compliance

Please ensure you verify the presence of all items listed in the "ATTACHED DOCUMENTS" chapter, and promptly report any missing or illegible documents to the technical file manager.

If any part of the documentation is partially missing or illegible, we strongly recommend consulting the manufacturer before proceeding with any further operations involving the X350.

Personnel assigned to operate and maintain the X350 must carefully read this manual, with particular attention to the general safety regulations and execution methods outlined in sections relevant to their responsibilities.

This chapter provides an overview of the general safety rules applicable to all operations involving the X350. The intervention procedures described in the subsequent chapters must be executed in compliance with both the specified methods and the general safety rules outlined in this chapter.

Please note that safety regulations and usage and maintenance procedures serve as supplementary measures to broader workplace safety regulations that must be adhered to in all circumstances.

It is important to acknowledge that different industries or countries may have their own unique safety-related regulations. Therefore, it is specified that whenever the standards outlined in this manual conflict or are less comprehensive than the standards within a particular industrial sector or nation where the X350 is used, the standards of that sector or nation shall take precedence over the manual's guidelines.

---

### NOTE



Under no circumstances can the manufacturer be held responsible for accidents or damages resulting from use by unfit or inadequately trained personnel, or improper use. In addition, any partial non-compliance with safety regulations and intervention procedures exempts the manufacturer from liability in such situations.

---

Failure to adhere to the rules of use and intervention methods outlined in the manual will also result in the expiration of the warranty terms.

---

### Introduction

This manual serves as a comprehensive guide aimed at acquainting operators with accident prevention regulations and essential behavioral guidelines, laying the foundation for the correct and safe utilization of the machine while striving to minimize the occurrence of accidents.

To maintain the readability and structure of this booklet, legal provisions are presented briefly; however, they serve as a valuable reference point for those seeking more in-depth information on the subject. With the enactment of Legislative Decree No. 626 on 19/09/1994, along with subsequent amendments (81/08), the legislator established a fundamental principle: all specialized equipment must be operated solely by individuals who have received adequate and specialized training. This training is intended to ensure that the machine is used correctly, considering potential risks to oneself and others. Consequently, the operation of this machine should be entrusted exclusively to authorized personnel.

### Safety regulations

While operating the X350, it is conceivable that situations of incorrect operation, not covered in the manual, may arise. These exceptional circumstances can occasionally result from environmental factors or unforeseeable equipment failures beyond the manufacturer's control.

If you find yourself in a situation where you believe it is necessary to perform an operation or intervention not outlined in the manual, or if you must deviate from the specified procedures, we strongly recommend seeking consultation with the manufacturer to confirm the feasibility of your actions before proceeding.

It is imperative that the personnel responsible for managing, operating, and maintaining the X350 retain a copy of this manual. In the event of damage or loss, clients have the option to request a certified copy from the manufacturer's internal security service. We advise keeping a backup copy in a secure location to prevent any potential damage or loss.

To prevent hazardous situations, it is essential for all operators to meticulously peruse the documentation provided for the X350. This ensures a comprehensive understanding of usage and intervention methods before commencing any form of operation.

### General description

The machine detailed in this document is a compact digital printer designed for roll-to-roll printing applications. It is equipped with a user-friendly touch screen interface, facilitating precise configuration of the printing process. Additionally, the printing configuration can be remotely managed, offering flexibility and convenience in operation.

The X350 Digital Roll to Roll Press is a high-speed, versatile, and durable printing solution that's perfect for production-level inkjet roll to roll printing. With a print speed of up to 45 meters per minute and a large media capacity of 350mm roll diameter and width, the X350 can handle a variety of media sizes and types with ease. Its compact design (under 1 sqm footprint) makes it easy to integrate into any production environment.

It is designed to deliver vibrant, professional-quality prints on die-cut or continuous label materials and flexible packaging films for a wide variety of product applications.

### Technical data

Description	Unit	Value
Dimensions	mm	1040 x 710 x 1570
Weight	kg	280
Power supply		230VAC 50/60Hz
Electrical safety class		I - earthed
Protection rating		IP20
Power (max)		2.8KW
Sound level	dBA	<70
Printing speed	m/min - 1600x954	45
	m/ min - 1600x1600	27
Number of ink cartridges		4
Ink cartridge capacity	ml	2000

### Noise

The X350's operational noise levels during use are within a range that does not exceed 70 decibels (dB). Consequently, there is no requirement for the user to wear protective headphones during work phases.

However, it is important to note that certain working environments or specific processes may generate noise levels exceeding 70 dB. In such instances, it is imperative for the operator to equip themselves with appropriate protective Personal Protective Equipment (PPE) to safeguard their hearing.

### Identification plate

The machine is outfitted with an identification plate that displays essential product identification details and key technical data pertaining and power requirements.



#### ATTENTION

To preserve the integrity of all machine components, it is imperative to adhere to the technical data provided on the plate.

---

Additionally, the identification plate prominently displays the CE marking, signifying compliance with relevant European Union standards and regulations.

---

### System Components

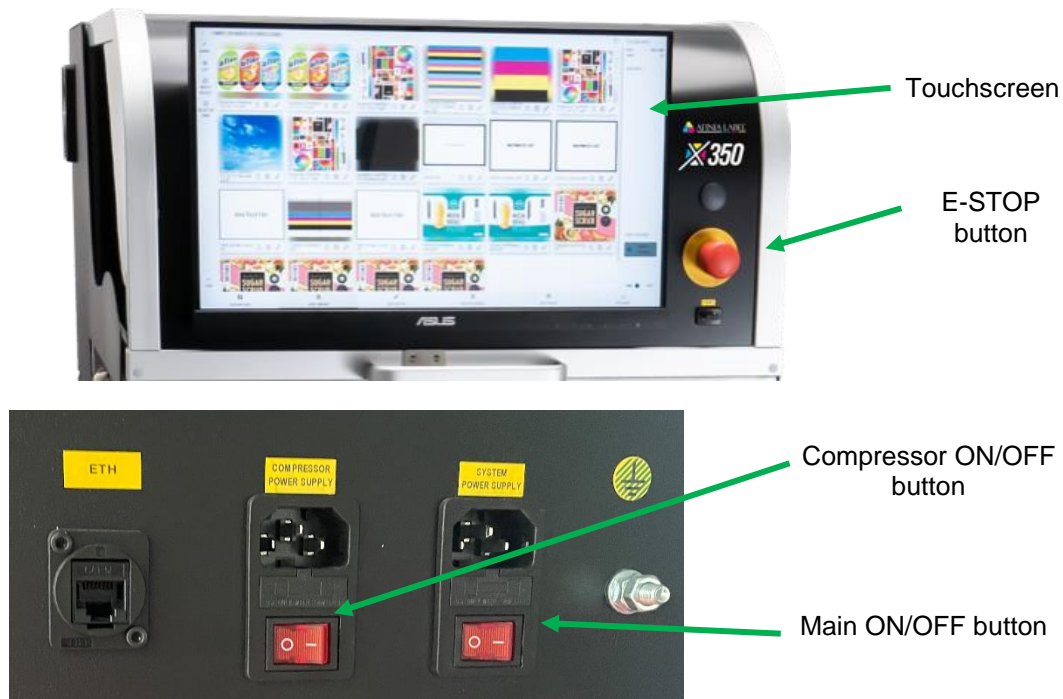

The control devices incorporated into the machine include:

1. Touch screen display
2. Emergency mushroom button
3. Main ON/OFF switch
4. Compressor ON/OFF switch

---

#### ATTENTION



The efficacy of the control devices is assured only when the machine is used in accordance with the guidelines outlined in this manual. Specifically, maintenance operations must be conducted meticulously and should not be altered in any way.

---



### DANGER

Modifying the control system of the machine is strictly prohibited. The manufacturer disclaims any responsibility for consequences arising from improper and unauthorized usage of the machine resulting from tampering and negligence by an operator.

---



### DANGER

All individuals tasked with performing operations on the machine must possess a comprehensive understanding of the control system's meaning and functionality.

---

## Feasible operations

---



### ATTENTION

It is important to note that since it is impossible to enumerate all operations that should not or cannot be carried out, any operations (beyond those considered normal) not explicitly detailed in the machine documentation are to be regarded as not feasible.

---

Feasible operations are exclusively those explicitly stated in this manual within the "INTENDED USE" section. Anything that falls outside this scope, as well as partial or complete deviations from the procedures delineated in the manuals, can lead not only to operational errors but also to accidents resulting in severe damage to both the machine and its operators.

---



### NOTE

The manufacturer cannot be held accountable for any accidents or damages stemming from unintended and unauthorized use of the machine.

---

## Intended and unintended use of the machine

### Intended use

The machine is designed for use in professional environments, primarily for inkjet printing operations on paper and/or compatible materials. It is particularly well-suited for printing labels and flexible packaging.

### Unintended use

Any use other than what is explicitly described in the "INTENDED USE" section is strictly prohibited. Specifically, the following actions are absolutely forbidden:

- Using the machine or its components for purposes other than those intended.
  - Replacing machine parts or components with those not authorized by Afinia Label.
-

- Tampering with or modifying the machine (both hardware and software).
- Employing unsupported accessories or consumables with the machine.

During operational phases, it is strictly forbidden to approach the machine's entire range of action.

The reuse of any part of the machine after it has been decommissioned absolves the manufacturer of any liability arising from such usage.

---

### NOTE



The manufacturer cannot be held accountable for any accidents or damages stemming from unintended and unauthorized use of the machine.

---

## Residual risks

---



### ATTENTION

In case of issues arising from a potential malfunction, it is essential to turn off the machine by releasing the maintained action controls and disconnecting the plug from the socket.

---

**WARNING!** When operating the machine, always wear CE-marked protective clothing appropriate for the specific hazards involved. The use of protective clothing does not eliminate the risk of injury but serves to mitigate the potential severity of harm in the event of an accident.

Pictograms are affixed to the X350 (refer to PICTOGRAMS). These pictograms must be maintained in a clean and intact condition and should be promptly replaced if removed or damaged.

During the use and maintenance procedures of the X350 machine, it is imperative to ensure the use of personal protective equipment (PPE), including:

- **Clothing:** Suitable for safeguarding against minor mechanical impacts and eventual ink contamination and/or spill during operations.
  - **Gloves:** Designed to shield hands from moving mechanical components and consumables such as inks.
  - **Safety Shoes:** Essential for all tasks where there's a risk of potentially hazardous objects falling, posing a cutting hazard.
-

- **Eye Protection:** To prevent ink or other materials from coming into contact with the eyes, appropriate eye protection must be worn at all times.



### DANGER

Access to the enclosed, protected, or internal components of the machine is permissible solely for extraordinary maintenance operations and exclusively by personnel authorized by the manufacturer.

---

### Attention: Important

- **Do not modify any component of the product.**
- **Do not reach out with your hands or hold objects with your hands near moving parts.**
- **Do not expose the electrical components of the X350 to water or other liquids.**
- **Never operate the machine when fatigued or under the influence of alcohol, narcotics, or medications that may impair your vision, judgment, or coordination.**
- **Maintenance must be carried out exclusively by following the instructions in the manual.**
- **The X350 machine is not a toy and must never be accessible to children for use.**
- **Inspect the assembly and setup of the machine before commencing any form of operation. Refer to the **Configuration** section for instructions.**
- **Never remove your Personal Protective Equipment (PPE) while operating the X350.**

In certain areas of the machine, residual risks may persist due to limitations in the design phase or the inability to employ guards, given the specific functionality of the machine. Safety pictograms are affixed to the machine to indicate the presence of such residual risks.

**WARNING!** Under no circumstances should you make modifications to the original configuration of the machine without explicit authorization from the manufacturer. Always utilize original accessories. Unauthorized alterations or the use of unauthorized accessories can lead to severe injury or even death, both to the operator and third parties.

**WARNING!** Improper or careless use of the X350 can render it a dangerous tool, capable of causing serious injuries or even fatalities. It is of utmost importance to thoroughly read and comprehend the contents of this instruction manual.

---



### IMPORTANT!

- Never modify the machine or operate it if it appears to have been altered by others.
- Avoid using a machine that is in a defective condition. Adhere to the usage and maintenance instructions outlined in this manual. Certain interventions require specialized personnel.
- Apply common sense at all times.
- It is impossible to foresee every potential scenario that may arise during the use of the X350. Always exercise caution and use common sense in situations where you may not feel adequately qualified. If you remain uncertain about work procedures, even after reviewing these instructions, consult with an expert before proceeding.

Don't hesitate to reach out to the retailer or manufacturer for any inquiries regarding the use of the X350. Afinia Label is readily available to provide guidance to enhance your utilization of the X350 machine in a safer and more effective manner.

**OPERATIONS THAT INVOLVE RISKS FOR THE OPERATOR:** During the commissioning operations, adhere to the general accident prevention regulations. While the design phase has already incorporated solutions aimed at ensuring the machine's safety across all usage phases, including transport, adjustment, operation, and maintenance, it is important to note that not all conceivable risks to operators and the environment have been entirely eradicated. This is due to both technological limitations (device reliability) and logistical constraints (excessive difficulties in elimination). Consequently, residual risks remain, including but not limited to the risk of cutting, crushing, shearing, electrocution, and more.

**Do not insert your hands, feet, or any other body parts into moving machine components while it is in operation. There is a high risk of entanglement and severe injury.**



All live electrical components within the system are effectively isolated and inaccessible, ensuring that they can never be reached by an operator during routine and proper operational activities. Live electrical components are consistently identified by the following pictogram.



### First Aid

To maintain a safe and secure work environment, it is imperative to ensure the presence of a fully stocked first aid kit near the work area. Promptly replenish any supplies utilized from the first aid kit to guarantee its readiness for any unforeseen incidents.

When seeking assistance, please adhere to the following guidelines to facilitate a swift and effective response:



**Location of the Incident:** Clearly specify the precise location where the incident occurred, providing detailed information to expedite emergency response efforts.

**Nature of the Incident:** Articulate a concise account of the circumstances surrounding the incident, elucidating the nature of the situation for a comprehensive understanding.

**Number of Individuals Affected:** Communicate the exact count of individuals who have sustained injuries, enabling responders to allocate resources appropriately.

**Description of Wounds:** Enumerate the types of injuries sustained, offering a succinct yet comprehensive overview to aid in prioritizing medical interventions.

**Identification Information:** Furnish the full names and surnames of the individuals involved in the incident, facilitating efficient record-keeping and communication among emergency responders.

# HANDLING AND CONFIGURATION

## Receiving the X350

Upon the machine's arrival, it is crucial to conduct a thorough inspection to ensure the integrity of the X350 and its constituent parts. In the event of any identified damage, deficiency, deformation, or signs of impact resulting from transportation, immediate notification to the manufacturer is imperative before undertaking subsequent operational steps.

### Detailed Examination Checklist

1. **Touch Screen Display:** Verify the intactness of the touch screen display, scrutinizing for any signs of damage or irregularities.
2. **Ink Tanks:** Inspect the ink tanks for completeness and structural soundness, addressing any discrepancies promptly.
3. **Printhead Box:** Ensure the integrity of the printhead box, detecting and reporting any potential issues arising from transportation.

### Included Items

Inside the crate, you will find the following essential components:

- X350 printer,
- 4x Ink Cartridges: Cyan, Magenta, Yellow, and Black colors,
- 1x Printhead,
- 1x wiper cartridge,
- 1x jack lift,
- 2x ramps.

### Machine Weight

Refer to the "TECHNICAL DATA" section of this manual and the product label for accurate information regarding the machine's weight.

### Machine Movement

When relocating the machine, it is essential to move it as a singular, assembled unit, incorporating its main components. Further guidance on handling operations is elaborated in subsequent sections of this manual.

By adhering to these handling procedures, you ensure the optimal condition and performance of the X350, promoting seamless integration into operational processes.



### DANGER

Exercise extreme caution and adhere to all safety instructions when engaging in machine handling operations.

---

### Subsequent Movements

Following the initial positioning, the machine may be relocated for production, logistical, or disposal purposes. Regardless of the circumstances, handling procedures must be strictly followed, as outlined in the subsequent sections of this manual.

---

### DANGER



Throughout the operational lifespan of the machine, modifications or additions may have been made to the configuration described in this manual. Before initiating any handling procedures, carefully review and take note of any changes. Incorporate these alterations into the weight assessment and follow the updated handling procedure.

---

### Manual Handling

The weight of the assembled machine is detailed in this manual and on the applied plate. Due to its weight and dimensions, manual movement of the fully assembled machine is not permissible. However, manual lifting of detachable parts is permitted, provided compliance with the maximum weightlifting regulations stipulated in Legislative Decree 81/08 governing workplace safety. Refer to the table below for precise weight limitations:

<b>Approximate values for maximum weight (in kg), frequent or occasional maintenance.</b>				
	<b>Men</b>		<b>Women</b>	
age	Occasional	Frequent	Occasional	Frequent
16 - 18	19	14	12	9
18 - 20	23	17	14	10
20 - 35	25	19	15	11
35 - 50	21	16	13	10
più di 50	16	12	10	7
Pregnant women				
<i>First 6 months of pregnancy</i>			10	5
<i>Starting from the 7th month</i>			0	0

To manually move the parts or consumables, observe the following steps:

**Grip Firmly and Safely:** Ensure the operator firmly and securely grasps the machine.

---

**Lift with Proper Posture:** Lift the machine with attention to maintaining a correct posture. Refer to the provided image for guidance:

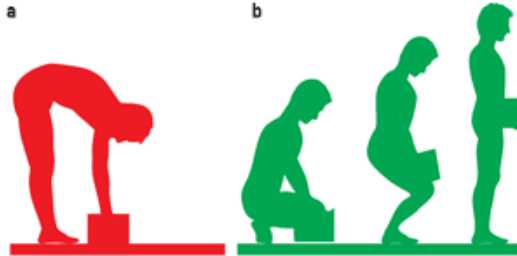

Incorrect Red Position - Correct Green Position

For relocating the entire machine manually, utilize the built-in wheels. Execute the operation as follows:

**Disengage Parking Brake:** Release the parking brake of the two front wheels located in front of the touch screen display by pulling the lever upwards.

**Secure Grip:** Hold the machine with care, using both hands and gripping its structure securely.

**Push/Pull Operation:** Maneuver the machine to the desired position by pushing or pulling it.

**Engage Parking Brake:** After reaching the intended location, engage the parking brake of the two front wheels located in front of the control panel by pressing their lever downwards.

**Attention:** Exercise caution during handling on wheels, ensuring it takes place on smooth and even surfaces with a maximum slope of 5°. Adhering to these guidelines guarantees safe and effective manual movement of the machine.

### Mechanical Handling

#### *Safety Regulations*

During the lifting and handling of system components, the following safety regulations must be strictly observed:

- **Restricted Access:** No individuals not responsible for the ongoing operations are permitted to stop or traverse the work area.
- **Safety Attire:** All handling personnel must wear compliant safety clothing, including gloves, helmets, and safety shoes.
- **Safe Distance:** During lifting, operators must maintain a safe distance from the lifted unit, ensuring they are never positioned beneath it.
- **Defect Correction:** In the event of any defect in slinging or balancing, or for any operation requiring personnel proximity, place the load on the ground. Correctly repeat the slinging/locking and lifting procedures.

- **Signal Personnel:** Individuals assisting in the operation must work in a clearly visible area to the lifting vehicle operator. They should solely signal to the operator and refrain from manual intervention on any suspended object.
- **Pre-operation Clearance:** Clear the work area of unrelated objects and ensure the floor is free from water, grease, or any substance that may pose a slip hazard.
- **Lifting Device Measurement Checks:** Verify the height measurements of the lifting device and ensure sufficient space for necessary movements, considering rope length, unit height, and desired placement.
- **Load Capacity Checks:** Confirm that the lifting system can adequately support the load's weight.
- **Flooring Evaluation:** Ensure the surface where the load will be placed can withstand its weight, with particular attention to the absence of live electrical lines.

### *Preliminary Checks*

Before initiating any movement, perform the following checks:

- No loose parts that could fall during lifting.
- No unsecured objects on or attached to the unit.
- Adequate area for safe system positioning and subsequent operator work.
- The support surface must support the system's weight (refer to TECHNICAL DATA).

### **Lifting a Unit (During Initial Positioning and Maintenance):**

1. Use four ropes attached to the base of the unit.
2. Ensure ropes have a minimum breaking load for safe lifting.
3. Lift the unit, placing it in the desired location with utmost care and adherence to safety protocols.

The unit may be moved using an overhead crane and/or a forklift, provided that these vehicles meet the necessary safety criteria and can support the load adequately.

---

#### **NOTE**



Damage to the unit caused by poorly carried out handling or caused by personnel not authorized to carry out the operation cannot be attributed to the manufacturing company, which assumes no responsibility.

---

**Uncrating X350**

The printer arrives packaged in a wooden crate.



Width		85 cm
Depth		123 cm
Height		185 cm
Gross weight		400 Kg
Net weight		280Kg

**Tools required:**

Reference	Quantity	Supplied	item
1	1	YES	Jack with wrench ratchet
2	1	NO	Wrench 10 mm
3	1	NO	Electric screwdriver with tip for Philips screw
4	1	NO	Forklift * (see the note)
5	1	NO	Plastic Hammer

\*Note: The forklift is not mandatory, but it is quicker than using the jack.



### Safety notes

### Warnings

During this procedure there are following risks:



Risk of eye damage



Risk of crushing hands



Risk of crushing feet



Attention: procedure not to be carried out alone, more people are needed

### IMPORTANT NOTE:

Before carrying out the instructions below, wear the personal safety devices required by workplace safety regulations. These devices are not included in the system.





### Unpacking Procedure

1. Place the wooden crate in a place with the following characteristics:

- Sturdy floor that must safely support the weight of 400 kg.
- Surface flat floor.
- Make sure there is a free area of at least 3.5 meters x 2.5 meters to operate.

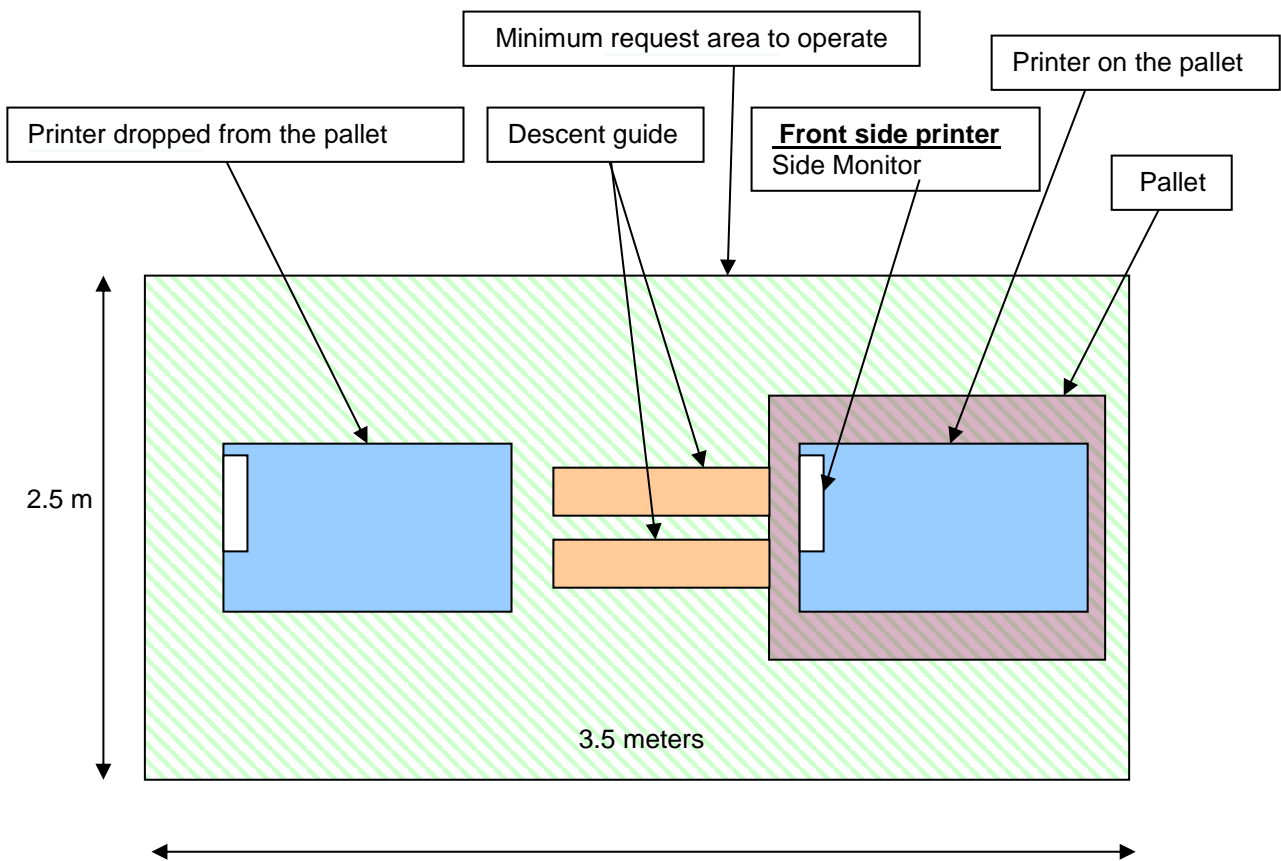

On the outside of the packaging, locate the vertical panel labeled FRONT. On this FRONT side the equipment will be lowered from the pallet using special guides. Orient the wooden case so you can unload the printer in the correct way.

2. Remove the Philips screws (4x 60 mm) on the 4 border sides of the top panel and remove it.

**Attention: the panels are heavy.**

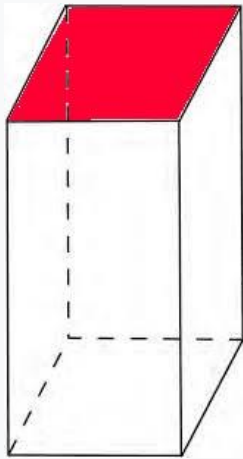

Position of the screws on the crate



3. Remove the Philips screws on the 3 border sides of the front panel and remove it.



4. Remove the Philips screws on the 2 border sides of the right-side panel and remove it.



5. Remove the Philips screws on the 2 border sides of the left side panel and remove it.

The position of the screws is similar to that indicated in the previous step 4.

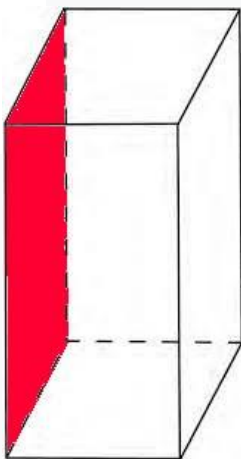

6. Remove the Philips screws on the 1 border bottom side of the rear panel and remove it.

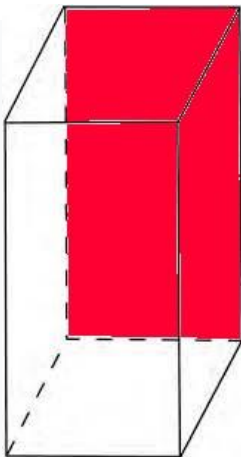

7. Remove the transparent plastic protective bag and the monitor protection polystyrene panel.



8. Take the print head and the wiper that are resting on the printer table and temporarily store them in a safe place.



9. Remove the 2 wooden guides and the lifting jack kit located under the printer.



10. The printer is fixed to the wooden pallet with 4 long threaded steel rods.



11. Using two wrenches, hold the upper nut still while unscrewing (about 2 cm height) only the lower nut, the rod will slowly move upwards. Completely remove the rod. Repeat the operation on the other 3 remaining rods.

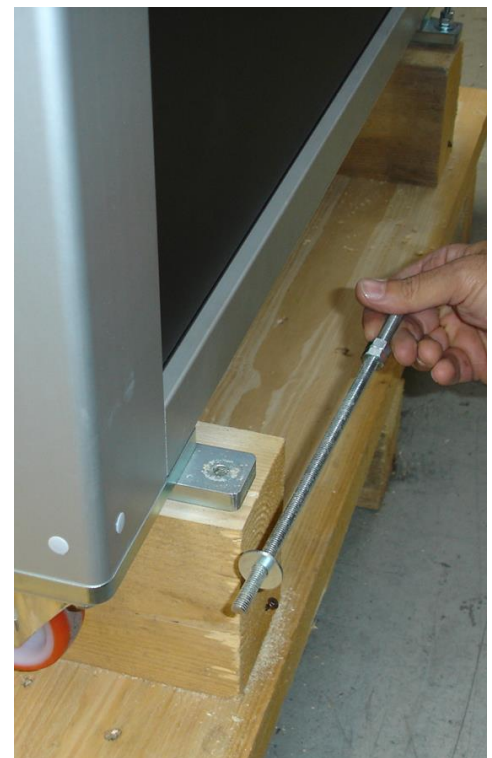
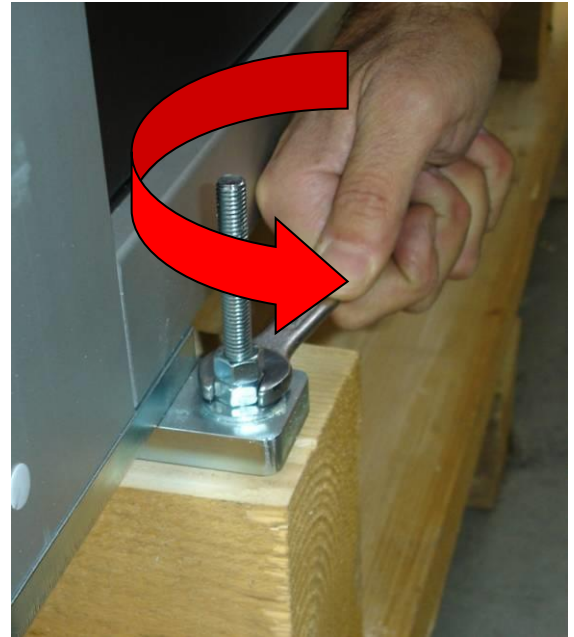
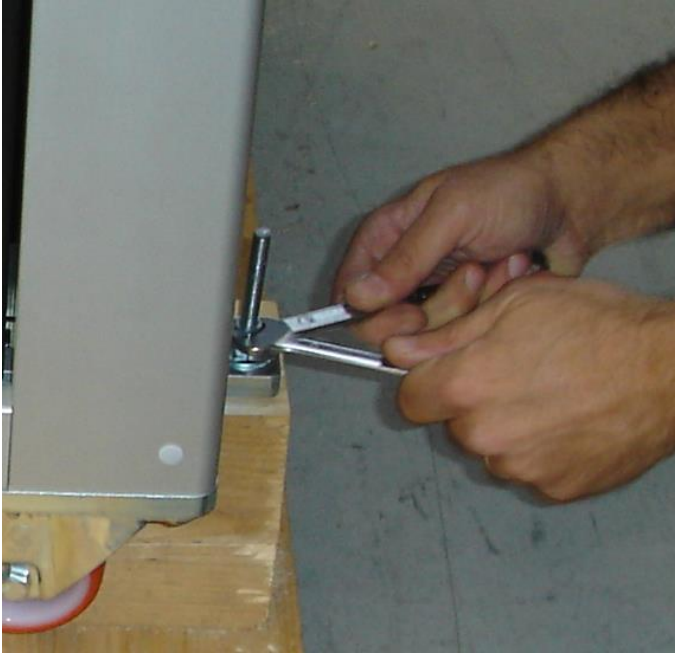



12. Now the printer is free from the wooden pallet. If you have a forklift, lift the printer following the step 13. If you do not have a forklift, follow the step 14.

**13. Procedure with forklift**

Spread the forks as much as possible and position them as shown in the photo and make sure that the forks protrude from the other side. Very gently lift the forks and move the printer near the installation site.



The printer is equipped with 4 wheels to be moved on regular and flat surfaces. The 4 wheels are braked, move the brake lever to release them,

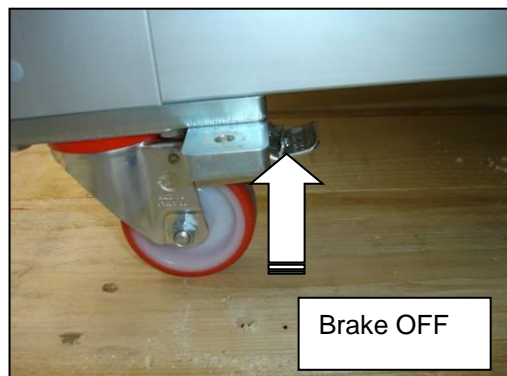
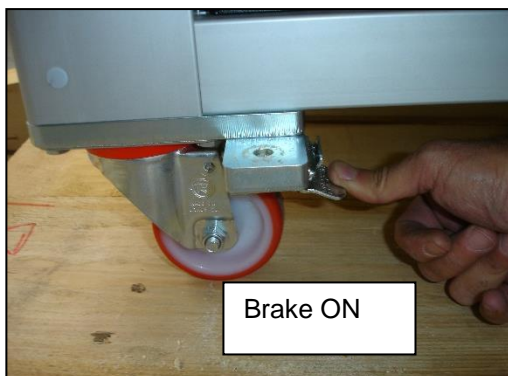

14. Procedure without forklift.

a) Insert the 2 wooden guides in front side of the pallet, aligning the reference marks.

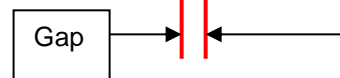
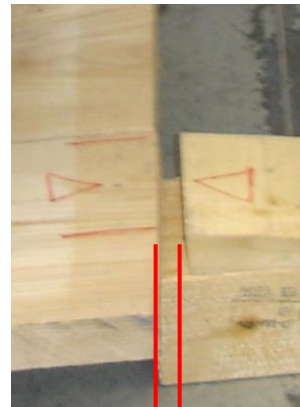
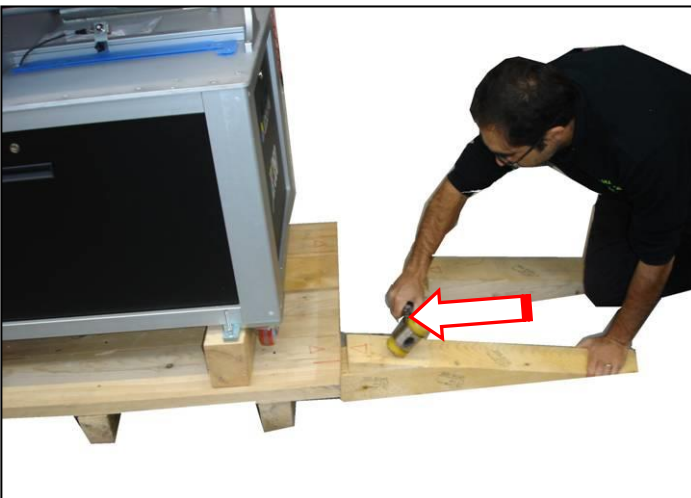
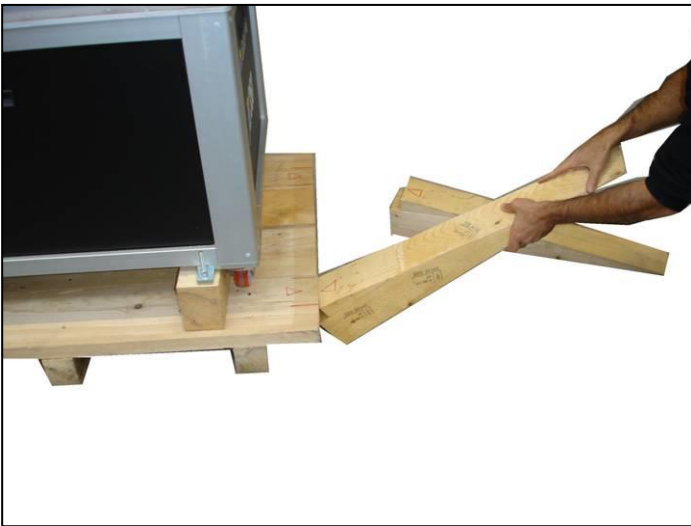

- c) Fix the 2 wood guides to the pallet. Locate the 2 holes (see the red marks) on the pallet into which to insert the screw to be fixed. Use 2 screws 4 x 60 mm removed from panel wood in the initial previous steps.

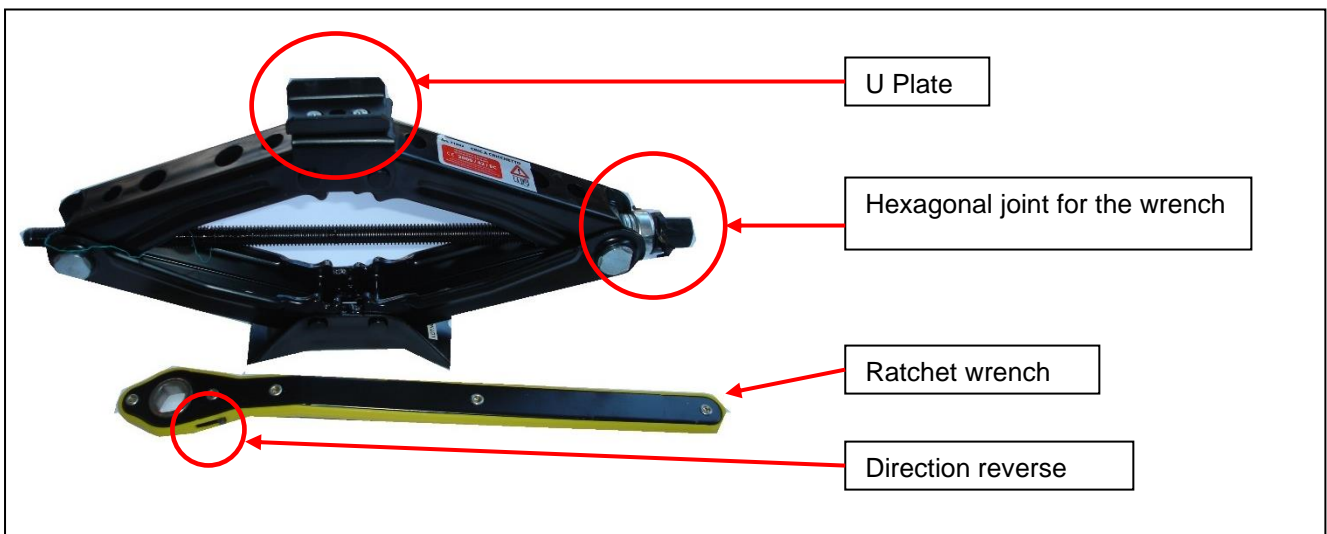
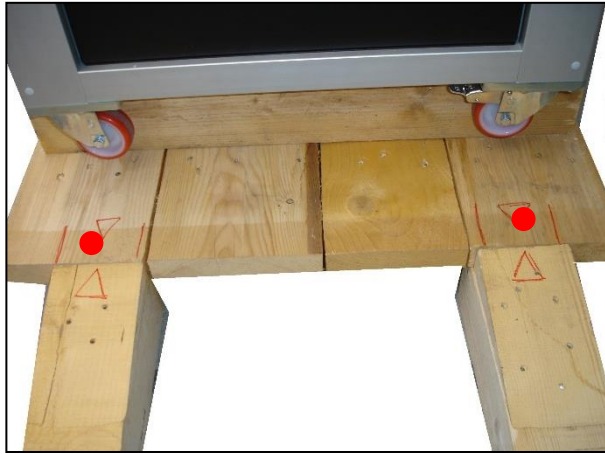

Place the jack on the pallet in the central area under the front frame bar and with the ratchet wrench begin to lift the jack until it reaches the level of the front frame bar, wait to lift the printer.

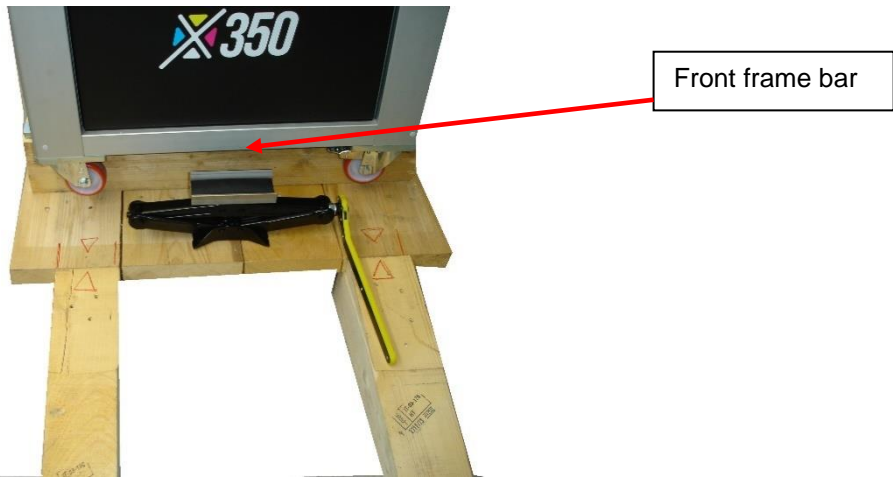

Make sure the U-shaped plate fits into the frame bar rail as shown in the photo, and now you can start to lift the printer with the jack.

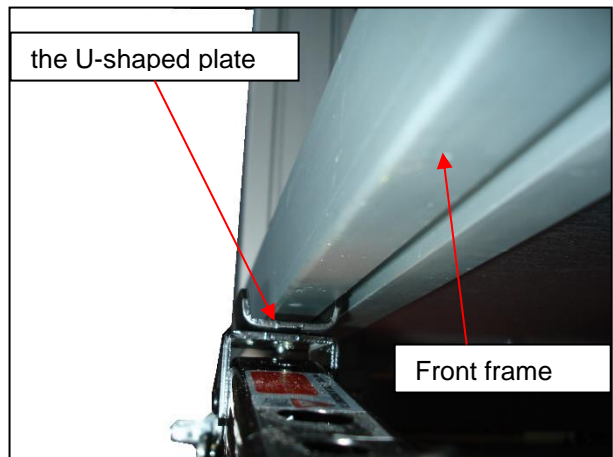
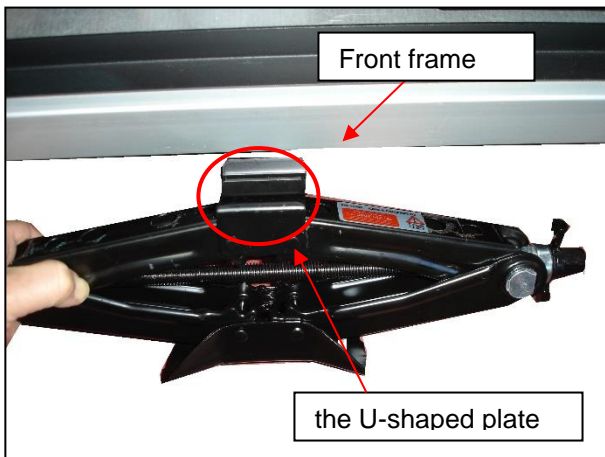

Raise the printer only 1 cm to create enough space to slide out the front wooden crosspiece.

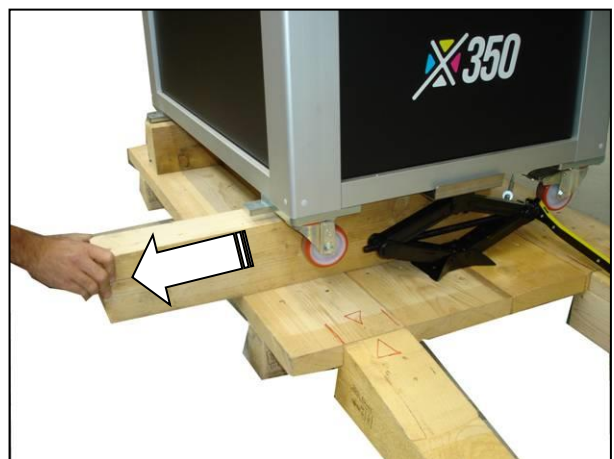
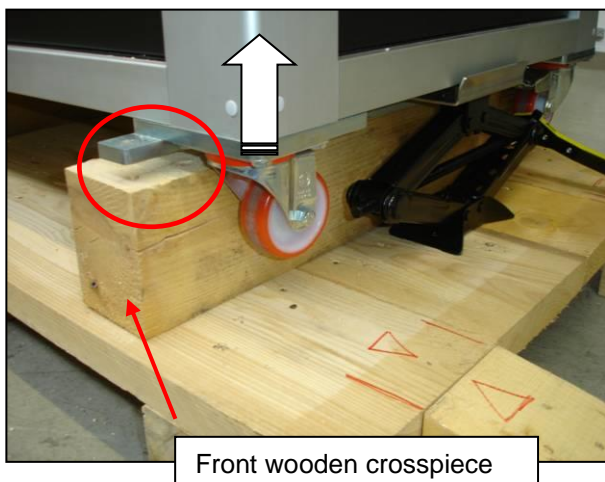

Before lowering the front side of the printer, put the brake ON both front wheels and position them parallel and orient them as shown in the photos.

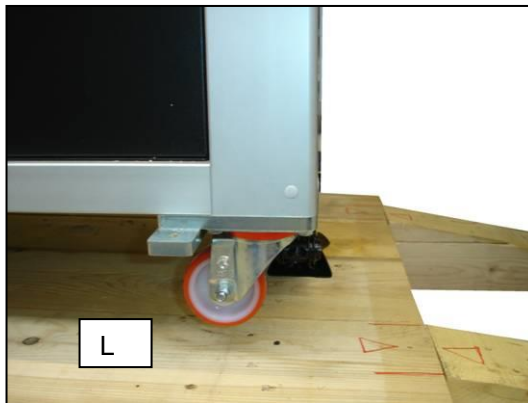
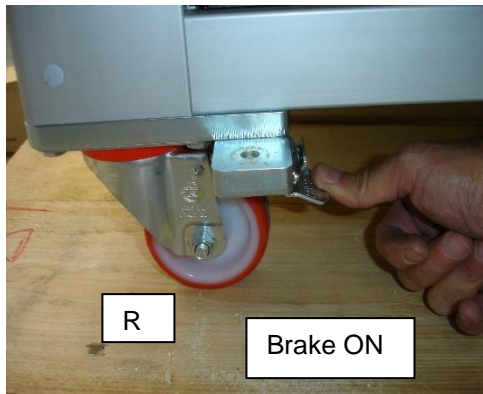
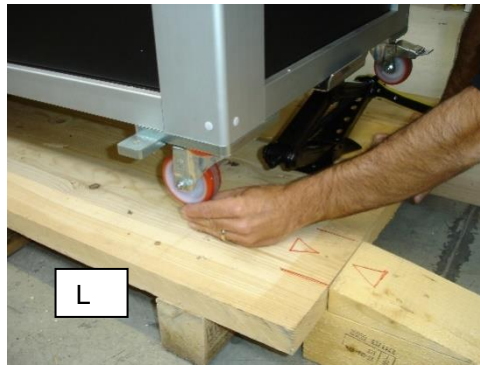
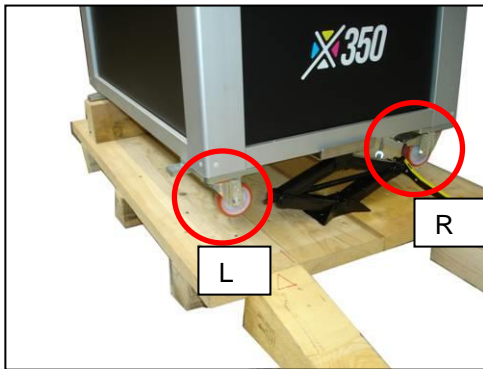

Lower the front side of the printer with the jack and remove it.

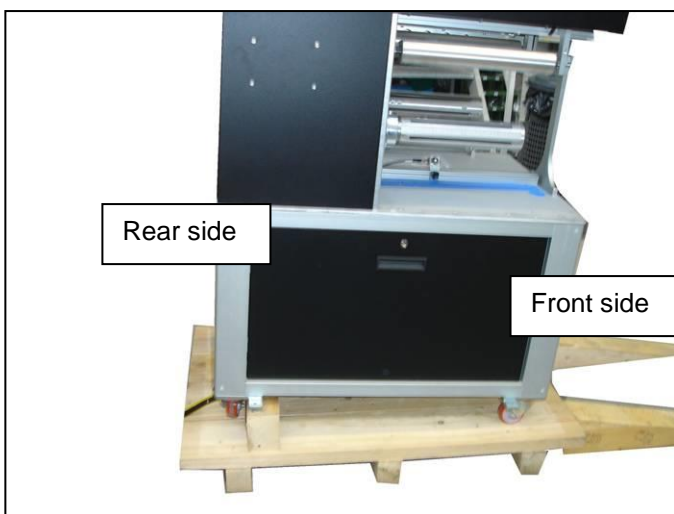

Place the jack on the pallet in the central area under the Rear frame bar and with the ratchet wrench begin to lift the jack until it reaches the level of the Rear frame bar, wait to lift the printer.

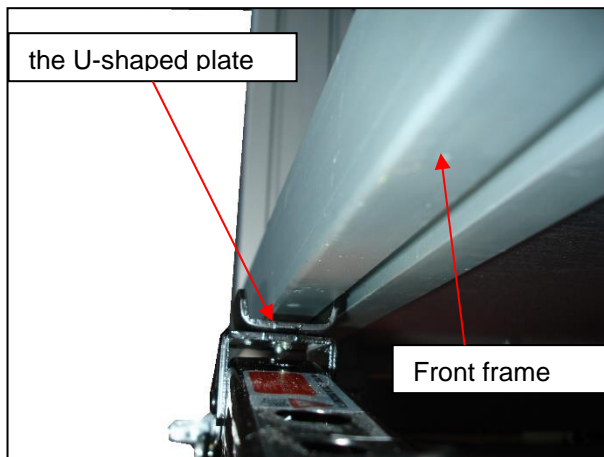
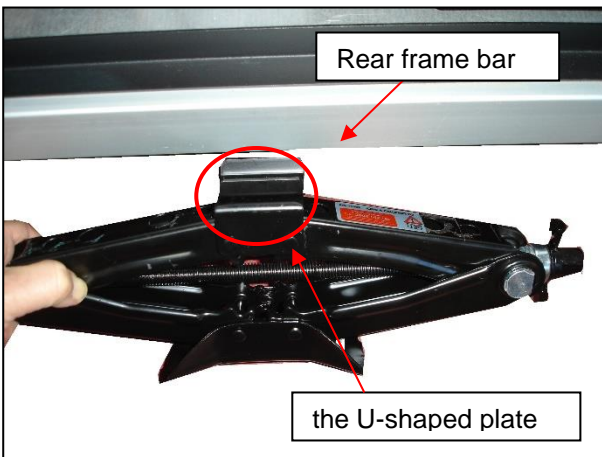

Raise the printer with the jack only 1 cm to create enough space to slide out the Rear wooden crosspiece.

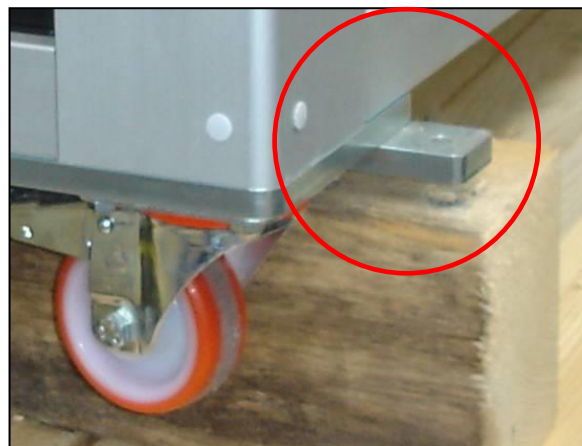
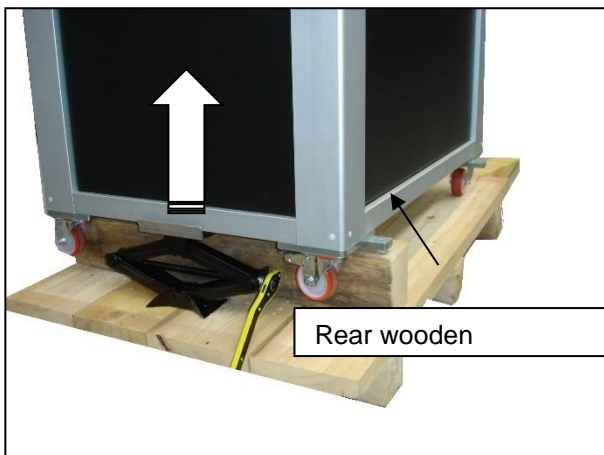

Remove the rear wooden cross piece.

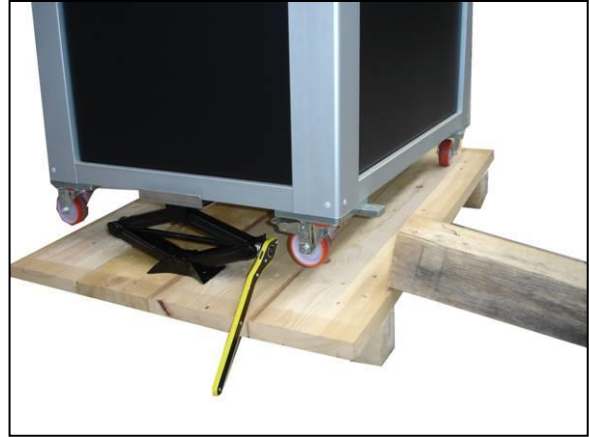
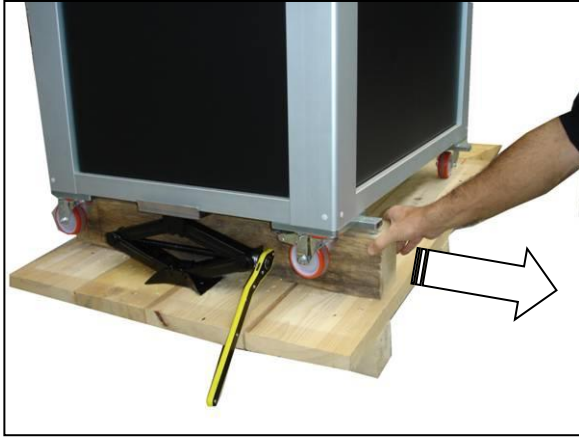

Before lowering the rear side of the printer, put the brake OFF both 2 Rear wheels and position them parallel and orient them as shown in the photos.

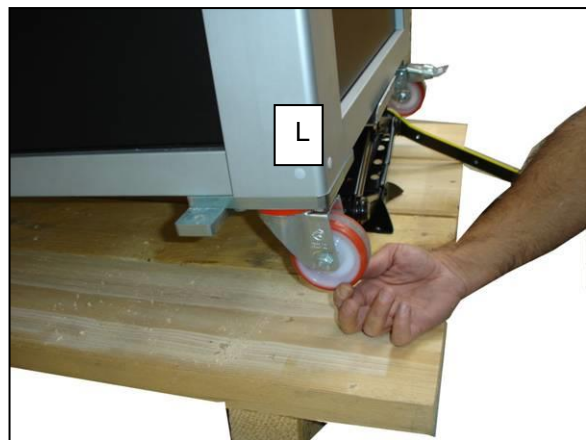
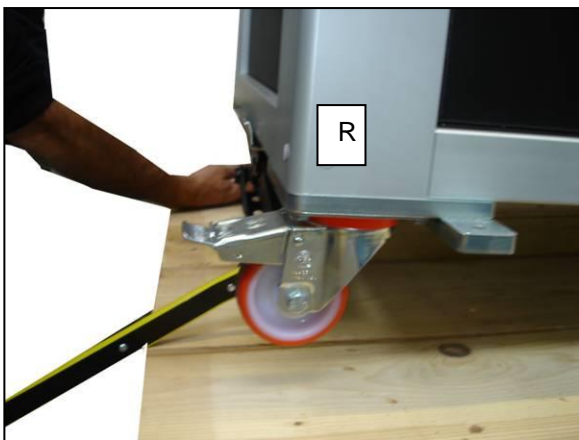
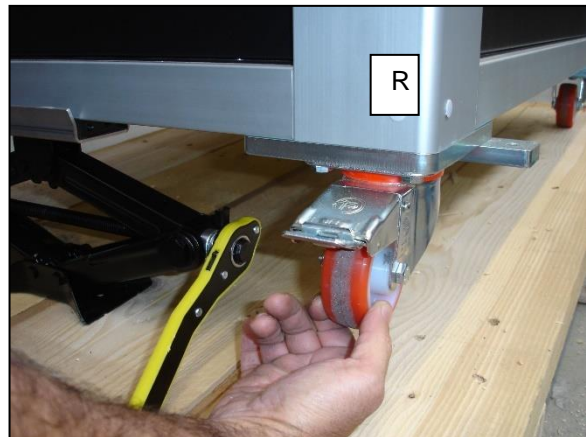
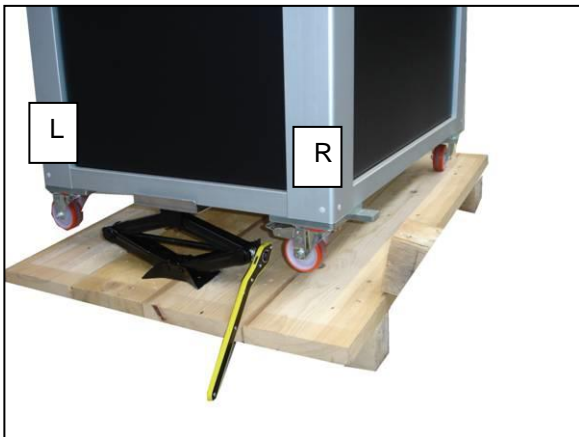

Lower the front side of the printer with the jack and remove it.



Check that the descent guides are aligned with the front wheels.





15. Remove the rear bottom metal panel of the printer.



Hold the printer in two people, one from the front and one from the back. Carefully look at the front and rear grip points.

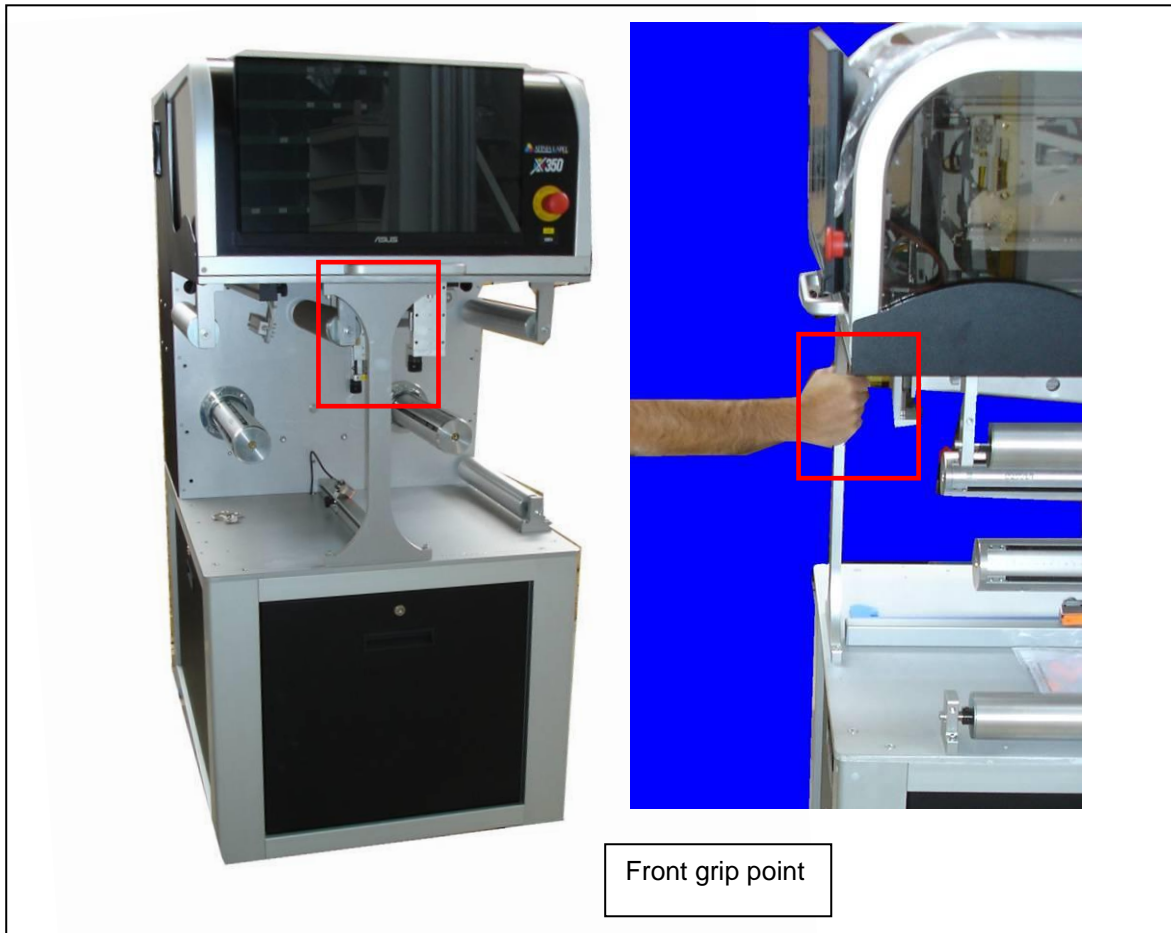

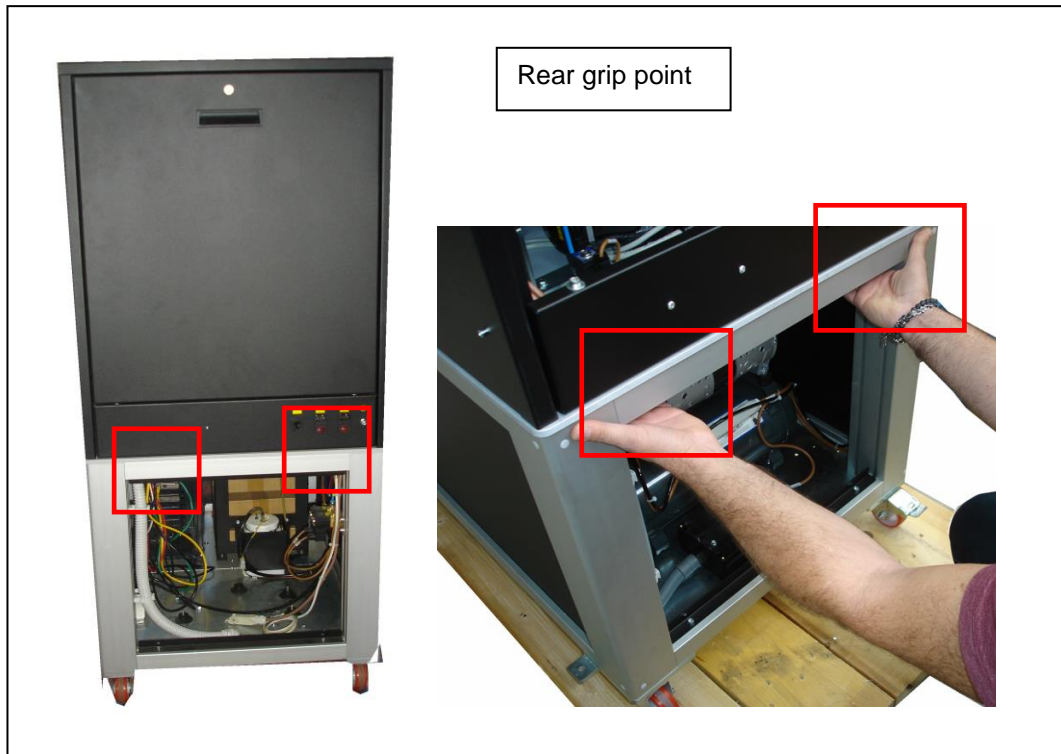

16. Disable the brakes on all 4 wheels.

17. Gently and very slowly move the printer toward the rails while a third person watches the wheels stay in the central area of the guides.





When the front wheels reach the floor, the printer will stop on its own.



19. Two people take the appliance from the back and finish the run until the rear wheels reach the floor.



20. Reinstall the back cover.



21. The printer now is ready for the installation.

22. Dispose of the packaging as required by current country regulations.



### Supported Environmental Conditions

#### Temperature

- Operating: 20°C to 30°C.
- Storage: 10°C to 40°C

#### Relative Humidity (Non-Condensing):

- Operating: 35% to 55% ±5%.
- Storage: maximum 65%

#### Warning

All machines undergo thorough testing and fine-tuning by the manufacturer before shipping to the user. Before commencing operation of the X350, ensure the complete removal of any protective coverings and packaging materials.

The X350 must not be used in environments with an explosive atmosphere.

#### Lighting Conditions

The lighting system (natural and/or artificial) in the area where the X350 is configured and used must meet the following minimum lighting values: 200 lux.

#### Electrical Connection Guidelines

**Maneuvering Spaces:** Ensure the system's connection to the electrical power supply line is organized to prevent interference with user maneuvering spaces.

**Differential Switch Installation:** Install a differential switch on the electrical power supply line with a capacity suitable for the installed power.

**Safety Precautions:** All connection, control, and routine/extraordinary maintenance work must be conducted in the absence of mains power.

**Power Adequacy Check:** Verify that the system is equipped to handle the maximum power absorbed. This includes checking the cable section and compliance with current legislation.

**Earth Connection Mandate:** Ensure a mandatory earth connection. Prohibit the use of pipes from water, heating, or gas systems for grounding the system.

**Avoid Adapters and Extensions:** Generally, discourage the use of adapters, multiple sockets, and/or extension cords. If unavoidable, use simple or multiple adapters and extensions complying with current safety standards. Take care not to exceed the capacity limit in terms of current value and the maximum power marked on the multiple adapters.

## LOADING MATERIAL

Install a roll onto the unwinder.

User the ruler to align the roll on the mandrel. Typically, the roll is centered on the mandrel, but can be placed in any location.



On the touch screen, go to Maintenance and then PLC. Scroll down and press Air in the Unwinder section.

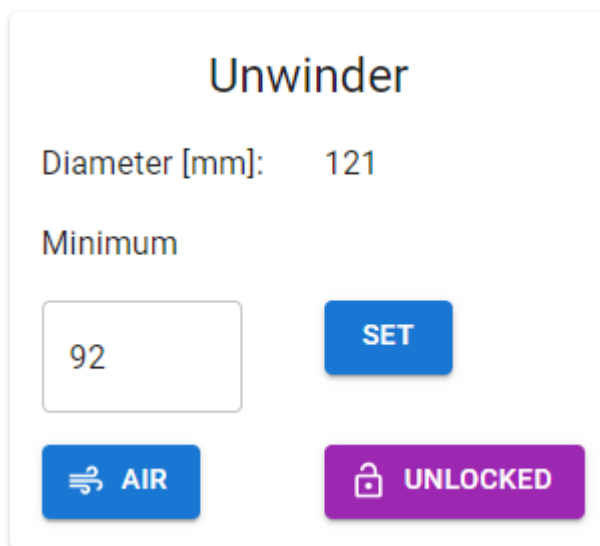

Lower the platen by removing the two thumb screws and moving out the two stops. This will allow the platen to be lowered.

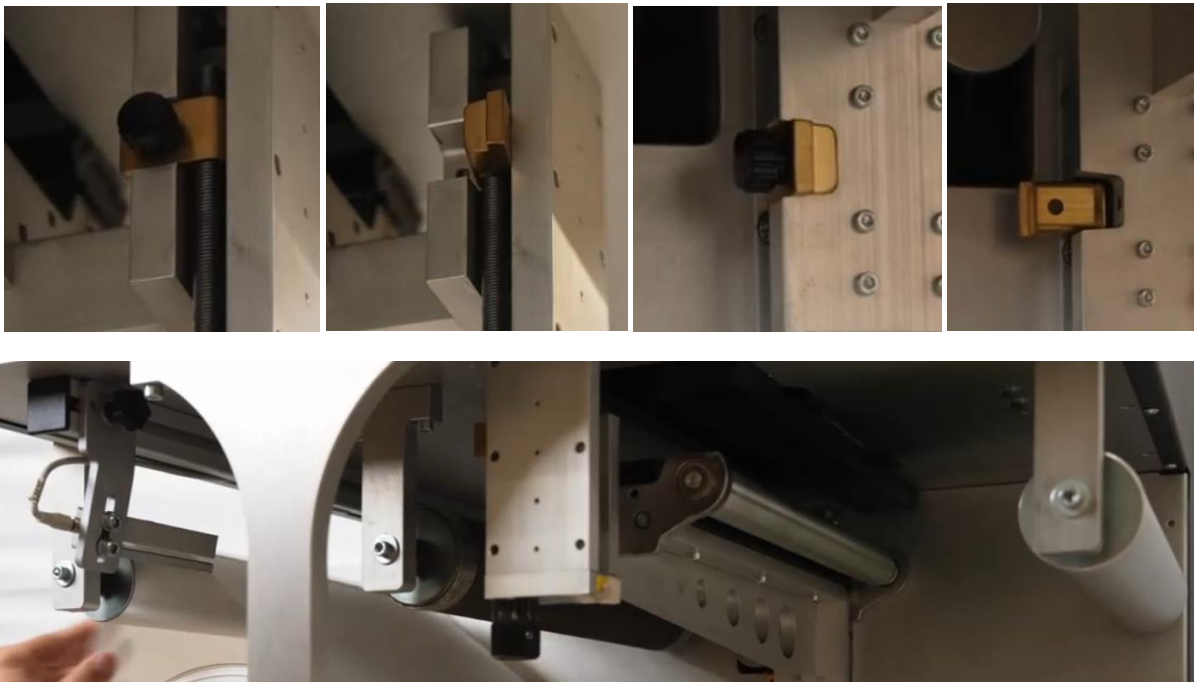

Route the material through the printer.

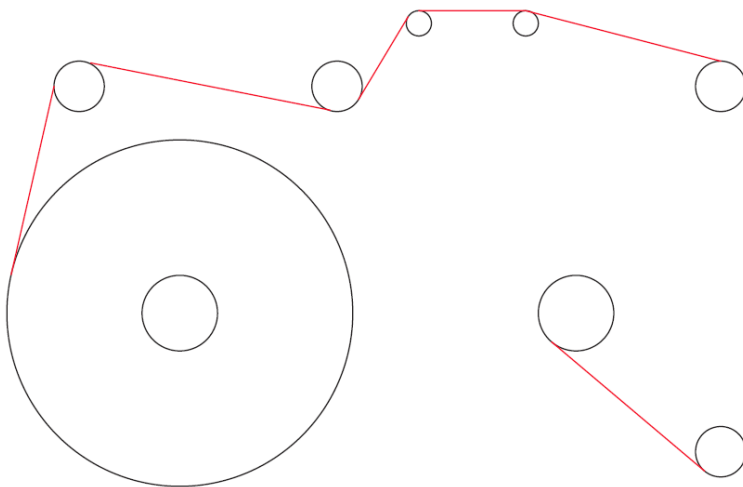

Install an empty core on the rewind mandrel. Place it in the same location as the rewind roll.

Once in place, go back to the touch screen, maintenance window, PLC and press Air in the Rewinder section.

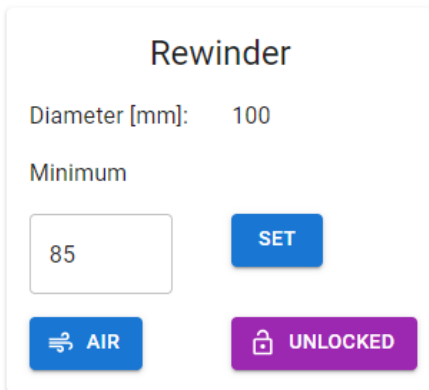

Tape the material to the unwind mandrel. You can verify the correct position of the material by measuring the distance between the back plate and the edge of the material.



Next, raise the platen back into position. Move the guides back into place and install the thumb screws.





Gap and black mark media specifications

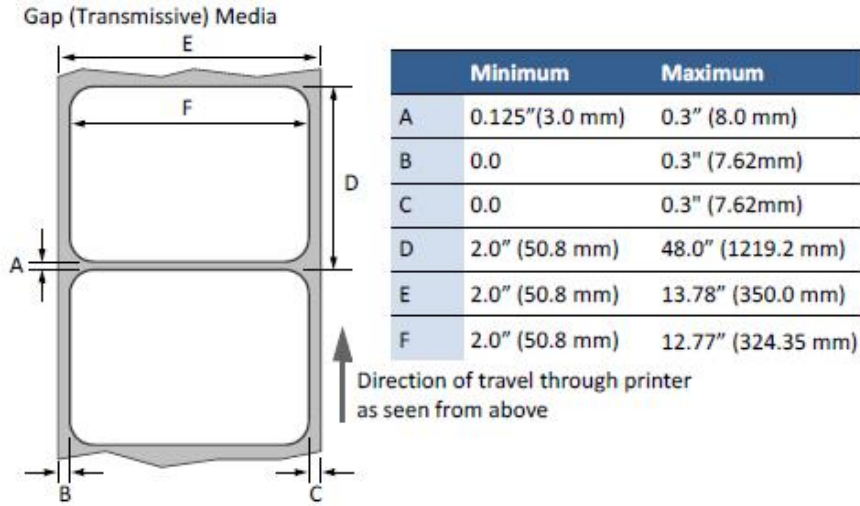

Black Mark (Reflective) Media

Reverse side of stock

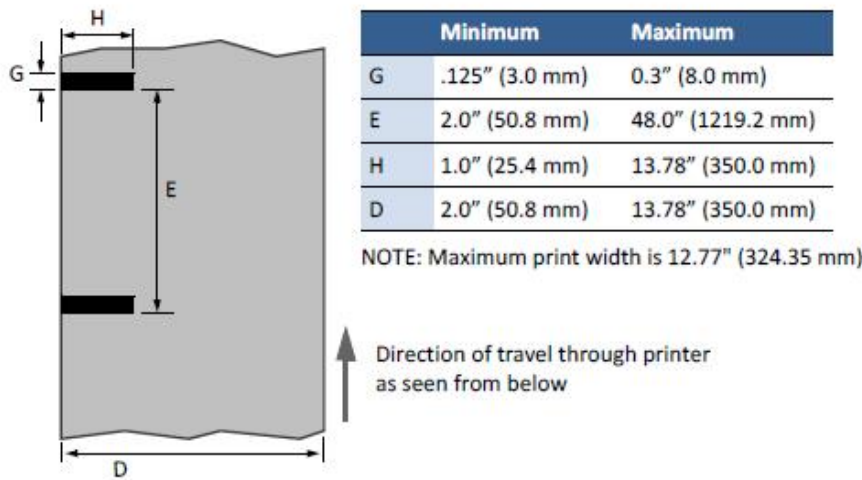

The fork sensor used to detect the black marks and gaps is located on the operator side of the printer. The black mark must be oriented as shown above, to allow the black mark to pass through the sensor.

Example shown here.



## SUBMITTING A PRINT JOB

### Ripping Image

Install USB drive in the front USB connection that contains the print file.

On the RIP tab, select Upload PDF files via File Browser. Browse to the USB drive and select the file.



If connected via network, go to the RIP tab and browse to the file or drag and drop the PDF.

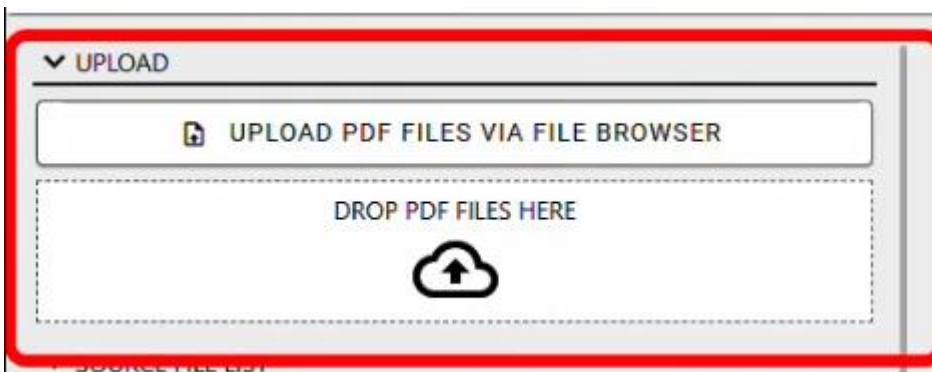

Scroll to the file and select it. The image will appear in the window.

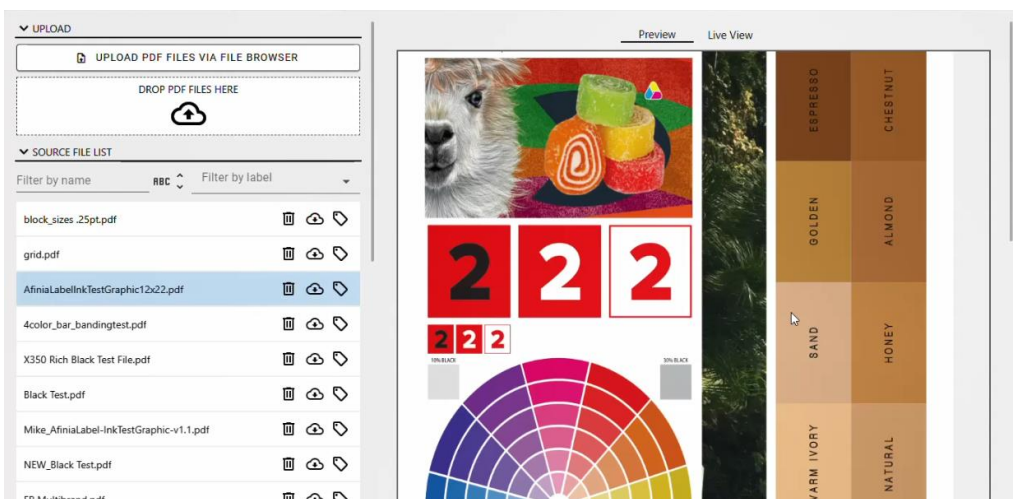

Select the configuration required.

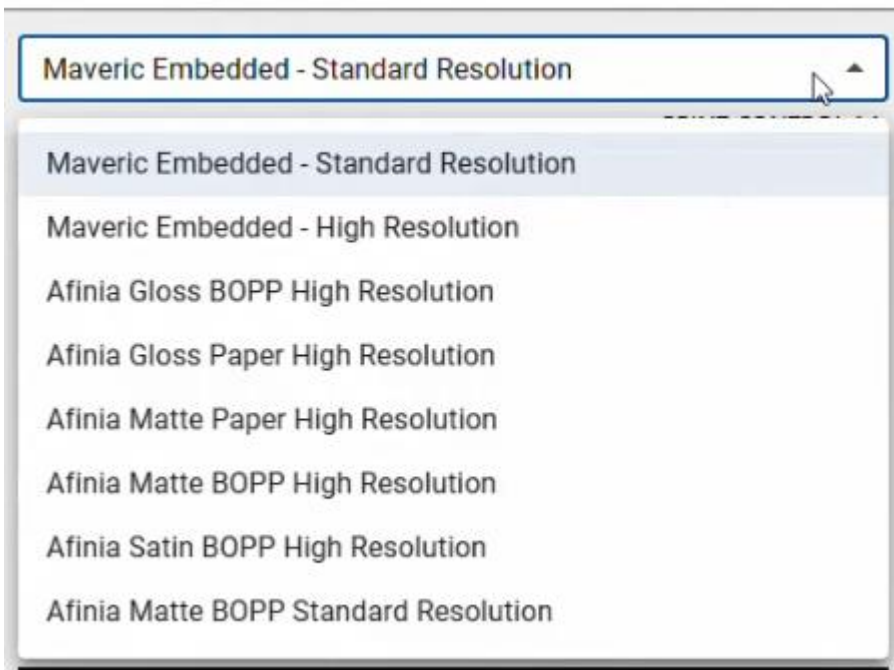

Under Size and Position, adjustments to the image can be made, such as centering the image, rotating, etc.

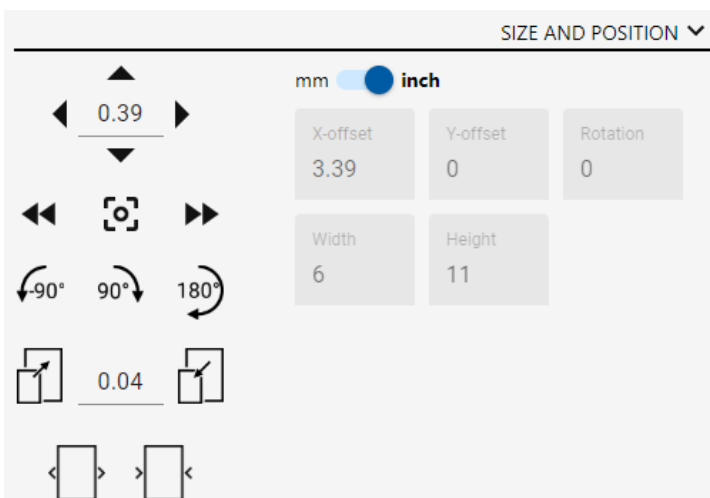

Select the number of copies.



Click Submit to Printer.



To set the media type, go to the maintenance tab, select print engine and make the selection under Media sensor settings. See page 60 for more details. If using gap or black mark media, sensor calibration details can be found on page 99.

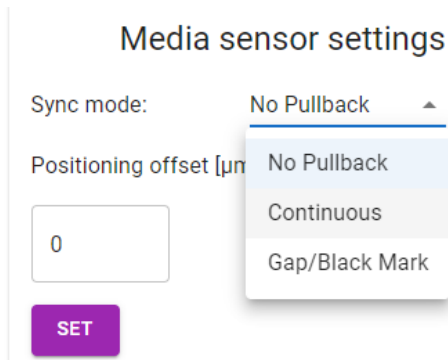

## Printing Image

If a job is submitted via RIP to printer, go to dashboard. The job will be shown.



Select speed



Press Start



To reprint a job, go to the job library, select image.



Select Print Selected.



Go to dashboard, job will be listed.



Select speed



Press Start



Press start.

# USER INTERFACE

## Dashboard

After turning the unit on, the Dashboard should be displayed.

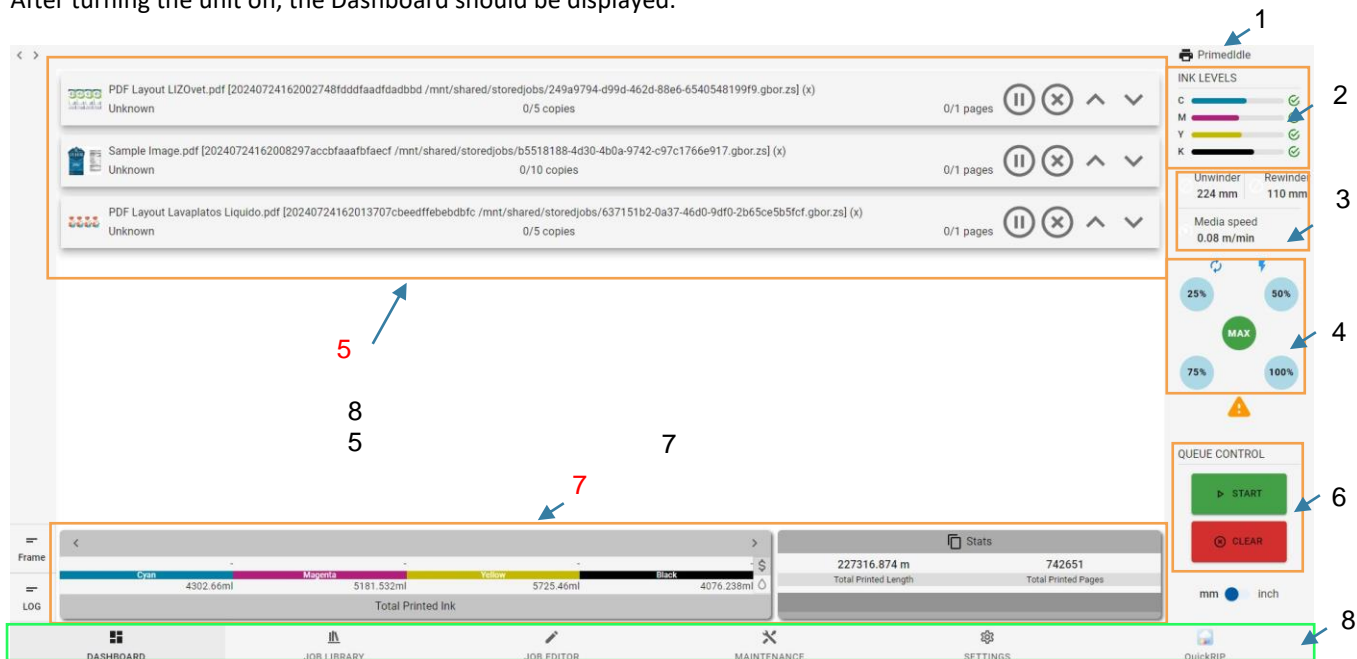

The dashboard has the following main elements:

1. print module status information
2. ink cartridge information
3. unwinder/rewinder and web speed information
4. quick-action buttons e.g., speed change, error, and warning info
5. job queue
6. job queue control buttons
7. generic statistics
8. page selector

1. Print module status information.

The list below explains the meaning of each state.

- **Off:** the print module is powered on but has not been initialized.
- **Initializing:** the print module is in the start-up process.
- **PrimedIdle:** the print module is in functional state.
- **Servicing:** the print module is executing a service routine.
- **Paused:** the print module has been paused during a printing session. The session could be restarted or cancelled with the job queue control buttons.
- **Fault:** the print module is in an erroneous state. Please check the fault details for further information and resolve accordingly. The unit has to be shut down, then perform the resolution steps and reinitialize.

- **DeprimedIdle:** the print module is in functional state, but the printhead is not filled with ink. Printing will not be possible in this state. Use the “Prime” maintenance function to load the printhead with ink.
- **Unknown:** the print module is in an unknown state, most likely it is powered down.

### 2. Ink cartridge information

The bars near the color codes relate to the amount of ink left in the corresponding ink cartridge. Next to the bars information icons can appear:



The ink cartridge is OK to use.



The ink cartridge has a warning condition. Check the maintenance screen for details.



The ink cartridge is empty.

Please note that the ink tracking algorithm will be accurate after the first ink set has been completely consumed. The level indicators with the first set of inks may be off. Once one or more cartridges from the first ink set gets to 30-40% range, observe the ink tubing on a daily basis.

### 3. Unwinder/rewinder and web speed information

This section displays the unwind and rewind roll diameters and the actual web speed.

### 4. Quick-action buttons e.g., speed change, error, and warning info

With the quick-action buttons the user can quickly change the web speed to predefined values of 25%, 50%, 75% and 100%. The selected speed will have a different background color than the others. If none of the buttons are selected from the quick-action buttons means that an intermediate speed is selected in the PLC maintenance screen. Max sets the maximum print speed for 1600 x 1600 resolution images.



Below the speed selector buttons the ALERT button may appear. The ALERT button with orange background refers to a warning state, while the red background means an error.























By clicking on the button, it will bring the user to the maintenance page of the component with the error/warning. Note that the error has a priority over the warning, so if an error and a warning condition is present at the same time, the red button will appear. Also, if multiple errors are present on multiple components, the button will bring to the maintenance page of the component with the highest priority.

### 5. Job queue

Jobs submitted from the RIP or selected from the Job Library will be added to the job queue. The printing sequence is from top to bottom.

When there is no active printing session:

- The job sequence could be reordered by pressing on the up and down arrows.
- Pressing the PAUSE button will set the job to PAUSED state. This will stop the printing session just before this job.
- Single jobs could be removed from the queue by pressing the related X button.

 BSB_Glory_Label5x8.pdf Unknown	0/8 copies	0/1 pages	   
 artwork5-SPACECIRCLE.pdf Unknown	0/11 copies	0/1 pages	   
 x350-Seltzers-3up-330x150mm1007.pdf Paused	0/10 copies	0/1 pages	   
 AfiniaLabel-Bleach.pdf Unknown	0/8 copies	0/1 pages	   

When the print session is active:

- The job reordering arrows will not work.
- Pressing the PAUSE button at any job will cause the print session to be paused.
- The job deletion button will not work.

## 6. Job queue control buttons



When one or more jobs are in the job queue, the START button will initialize a print session. The print session won't start if there is any component that is in erroneous state. If the printer is in PAUSED state, the START button will restart the printing session.

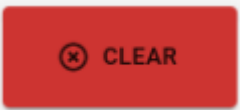

If the print session is not active, the CLEAR button will clear the whole job queue, while pressed during an active printing session will stop the print session immediately but won't clear the queue.

If the printer is in PAUSED state, the CLEAR button will stop the print session without clearing the remaining queue.



The PAUSE button will pause the active printing session as soon as it is possible. Pausing is not an immediate action. If pausing triggered at the very end of the queue, it may not be executed before finishing the print session.

## 7. Generic statistics

The left side of the statistics is dedicated to ink consumption related information, while the statistics on the right side are for media consumptions.

## 8. Page selector

The user can browse through the different pages using the page selector buttons at the bottom. The page selector is an always visible component.

Note: double-clicking on the DASHBOARD button in the page selector will refresh the whole page. This may be used when the UI gets irresponsive.



## Job Library

The job library stores the print jobs that have been previously generated. When a job is submitted by the RIP, a copy of the job will be automatically saved to the job library's root directory.

Note: the saved jobs are stored on an as-is basis, which means that there is no possibility to change the job settings in the job library, such as copy number (the UI shows it, but it's for future use), orientation, alignment, etc.

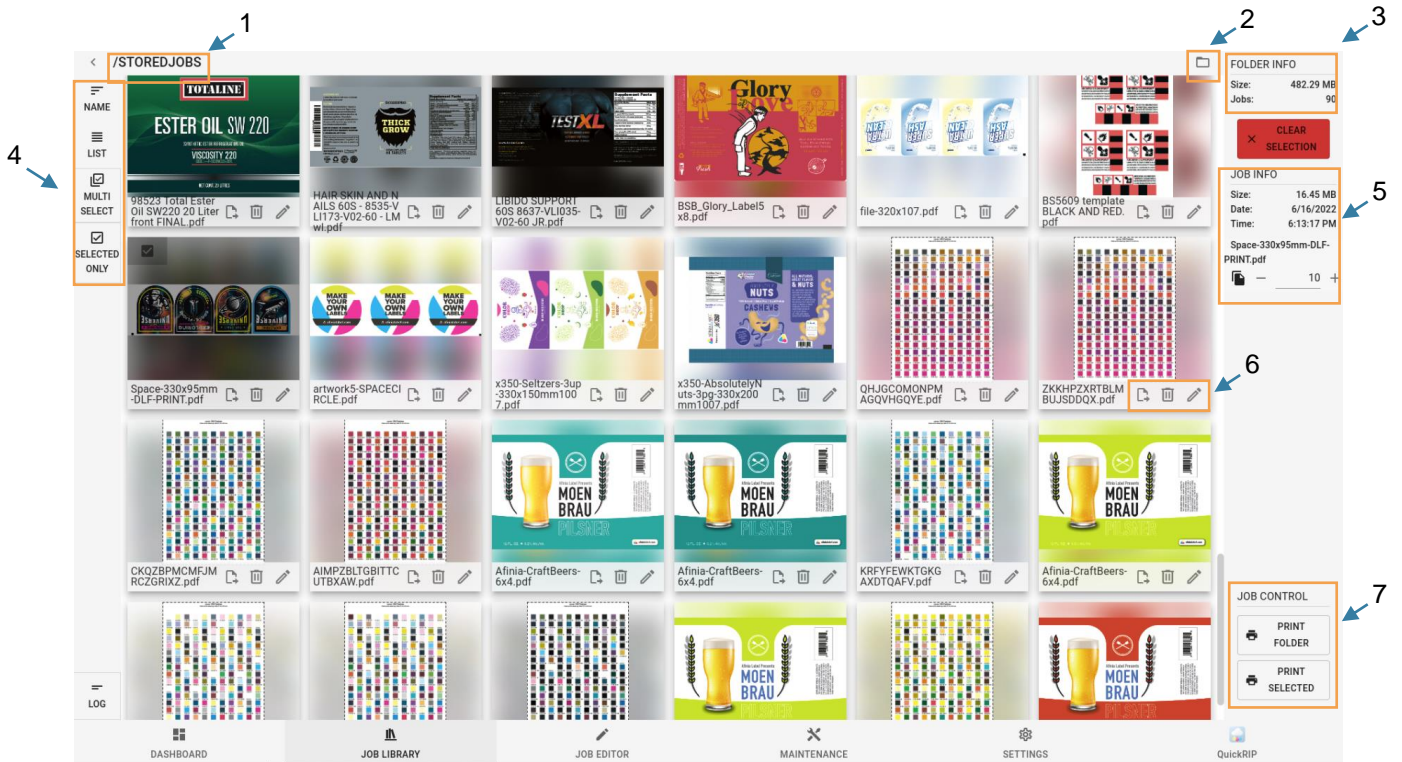

The main components in the Job Library are:

1. selected folder indicator
2. folder selector
3. folder info section
4. job organizer and selector options
5. job info section
6. job operations
7. job command section

1. Selected folder indicator

The indicator shows which folder is selected. The initial (and root) folder of the job library is the “/storedjobs” by default.

### 2. Folder selector

By clicking on the folder selector, the job library's folder structure will be displayed. Clicking on any of the folders, their internal content will be shown.

If a folder has one or more subfolders, a small triangle is displayed left to the folder's name. Clicking on the triangle will expand/close the subfolder list.

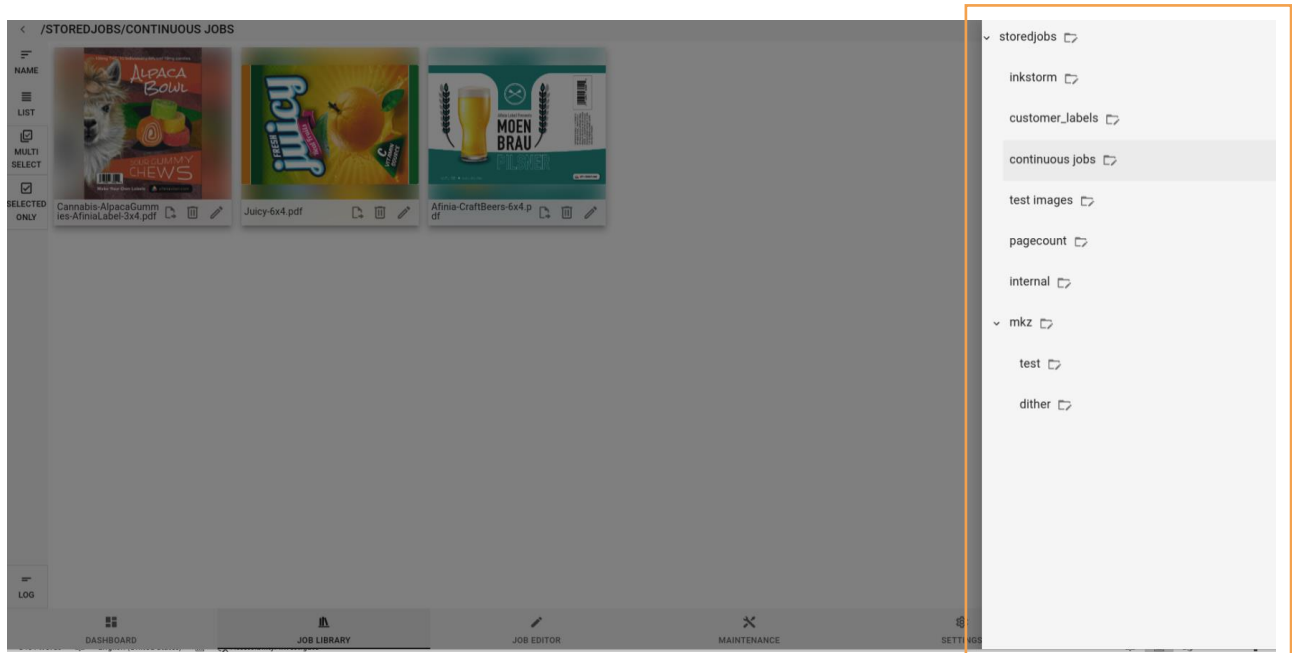

Pressing on the icon next to each folder will open the directory operation menu. The operations from left to right are:

- Add subfolder: typing in the new folder name in the popup window will create a subfolder under the selected parent folder.
- Delete folder: after confirmation, the folder and its content will be erased. The root folder of the job library cannot be deleted.
- Move folder: after clicking on the move folder icon, the destination folder should be selected. Once it is done, the original folder and its content will be moved into the destination folder.
- Rename folder: the selected folder will be renamed to the new given name.

### 3. Folder info section

In the folder info section, the number of jobs and the sum of the sizes are displayed.

### 4. Job organizer and selector options

The job list can be sorted by name or by creation date and displayed in grid or list layouts.

Enabling the multi-select option the operator may select multiple jobs for various operations. The user can quickly verify the selected jobs by clicking on the “Selected only” button which hides/unhides the not selected jobs.

## 5. Job info section

The job’s size and creation date and time is displayed in the job info section. If multiple jobs are selected the information relates only to the total size of the selected jobs.

Note: The job info field shows the original copy numbers. The UI lets this change, but it changes only visually, the copy count cannot be changed from the job library.

## 6. Job operations

At each job there are multiple operation buttons:

- Move job(s): clicking on the move job icon, on the right side the folder list will appear, where the operator can choose the target directory. This feature supports the move operation on multiple selected jobs.
- Delete job(s): clicking on the delete job icon will erase the job from the job library. This feature supports the delete operation on multiple selected jobs.
- Job editor: clicking on the job editor icon will open further details of the lastly selected job.

## 7. Job command section

From the job library the operator may submit only the selected job(s) to the print queue (PRINT SELECTED) or may decide to submit all the jobs in the active folder (PRINT FOLDER).

## Job Editor

The job editor gives more detailed information of the selected job.

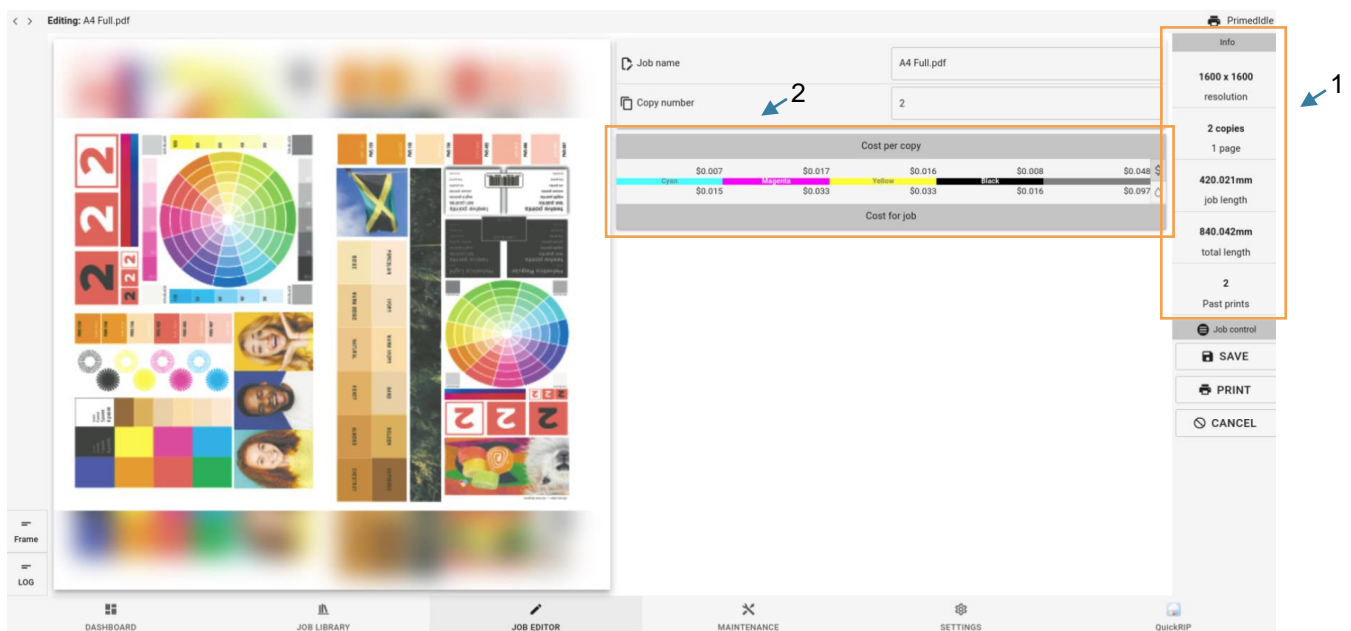

Note: on the job editor the function buttons are not functional, they are reserved for future use.

The highlighted components in the job editor are:

1. generic job information,
2. job consumption data.

1. **Generic job information**

Other than the job name and original copy number the rasterization resolution, the copy and page counts, the copy and job lengths and number of previous prints are visualized.

2. **Job consumption data**

The consumption data is calculated on the drop count that effectively is needed for the print. It excludes maintenance consumptions – such as KWS, cleaning, etc.

The consumption data field is split into two horizontal sections: the upper part represents the consumptions for a single copy of the job, while the lower part shows the values to complete the whole job. If a job has a copy count of e.g., 3, then the lower values will be 3 times the upper values.

Vertically the values are split by colors. The rightmost column is the sum of the colors.

By clicking on the drop sign, the consumption values are represented in milliliters; while clicking on the dollar sign, the values are transformed to currency (using the previously set ink prices in the “Printer Settings”).

## Maintenance

The maintenance functions are accessible after user authentication. There are multiple roles with different access levels:

- Operator: the base user level. This gives access to features that are essential to operate the machine on a daily basis.
- Admin: the administrator has access to features and configurations that help in tuning and/or basic troubleshooting the printer.
- Tech: the technician role gives full access for configuring, tuning and troubleshooting the printer.

## Signing in

To have access to the maintenance features, the user must sign in with the role he has access to.

The sign in process requires a username and a password. The default password matches the username for the operator and admin users. It is recommended to change the password during the installation procedure.

Note that the system supports one logged in user at a time. If a second user logs in, the previously logged in user will be disconnected.

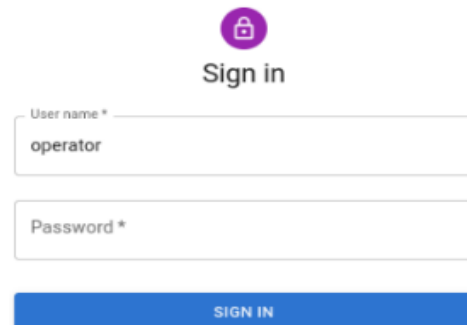

Sign in

User name \*  
operator

Password \*

SIGN IN

## Print Engine

The Print Engine page in the maintenance tab contains the DuraFlex print engine related settings and commands.

### Print Engine Panel

Command interface		■
Event interface		■
10GB interface		■
Print engine state	PRIMED_IDLE	
Event sequence number	401	
Session ID	1	
Command API Build ID	KPes 21.36	
Event API Build ID	KPes 21.36	

Under the Print Engine Panel, the Command and Event interface indicators should be green. This means that the print module is connected.

The Notification section shows the actual state of the print module. Information and warnings are displayed here, such as low level of ink or empty ink cartridge(s) are present, descriptions of error details.

Also, this section stores eventually the last error details.

### Notifications

Last engine error

2023-09-08T11:38:43 JobQueue: Job  
20230908093815246ffdeefbaefbdaef failed (PRINT\_SIGNAL\_ERROR)

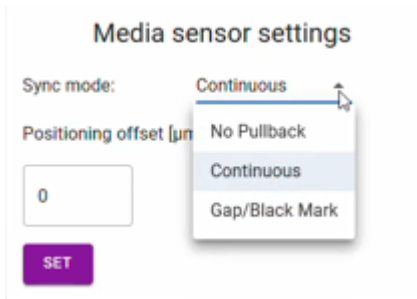
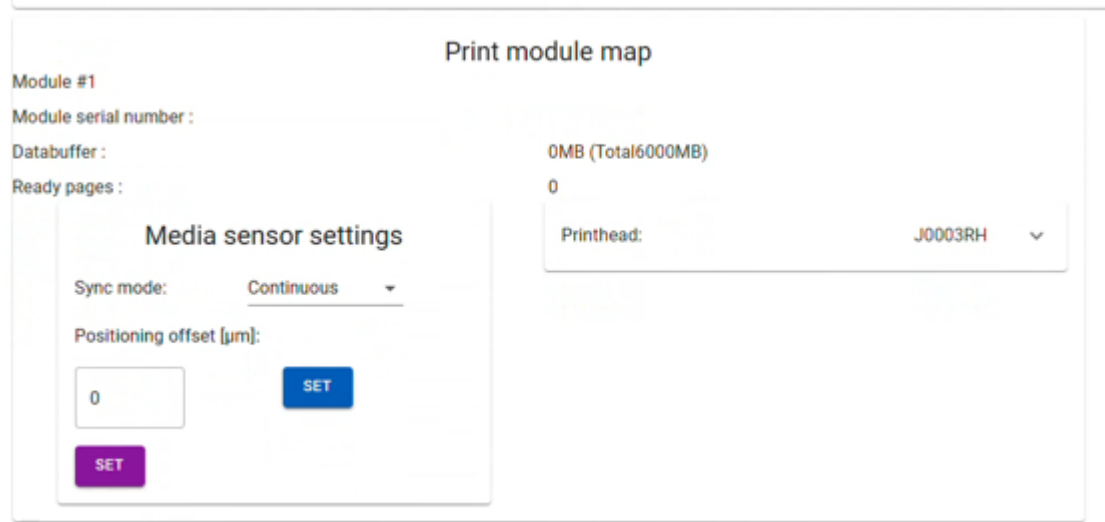

No Pullback – After printing, the media will not move back to the printhead. This setting is for continuous media.

Continuous – Continuous media, no gap or blackmark. Media will move back to the printhead after printing.

Gap/Black – Select when using gap or blackmark media.

Positioning Offset – adjusts the start position of the print. Used with gap or blackmark media.

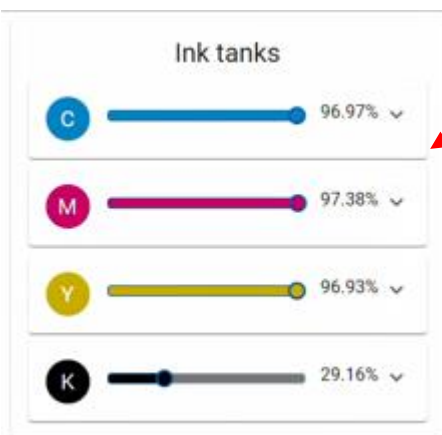

1



1. Shows the ink level of each ink tank.
2. Initialize – initializes the printer when in the Off state.
3. Shutdown – Turns off the printer.
4. Cleaning – Two levels for cleaning the printhead.
5. Position – Sets the printhead position, capped or raised.
6. Prime – Will prime the system with ink.
7. Deprime – Will remove ink from the tubes inside the printer.
8. Replace Wiper – Selected when the wiper module needs to be replaced.

## PLC

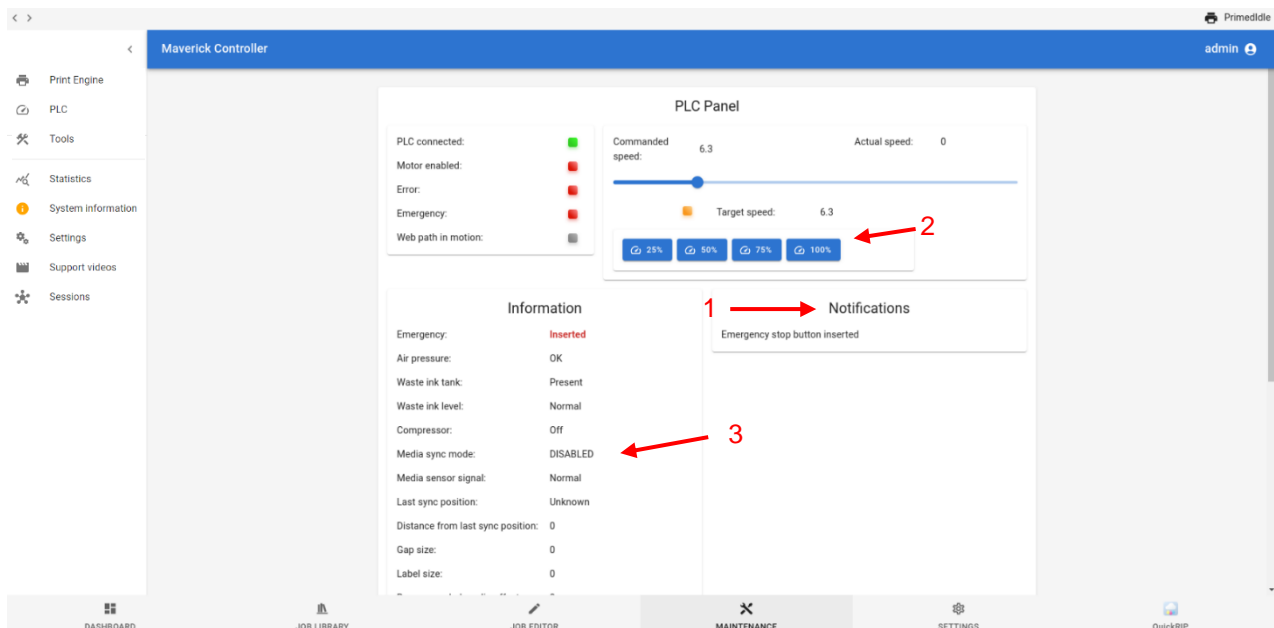

1. Shows system status under Notifications.
2. Set the print speed.
3. Current state of the components in the printer.

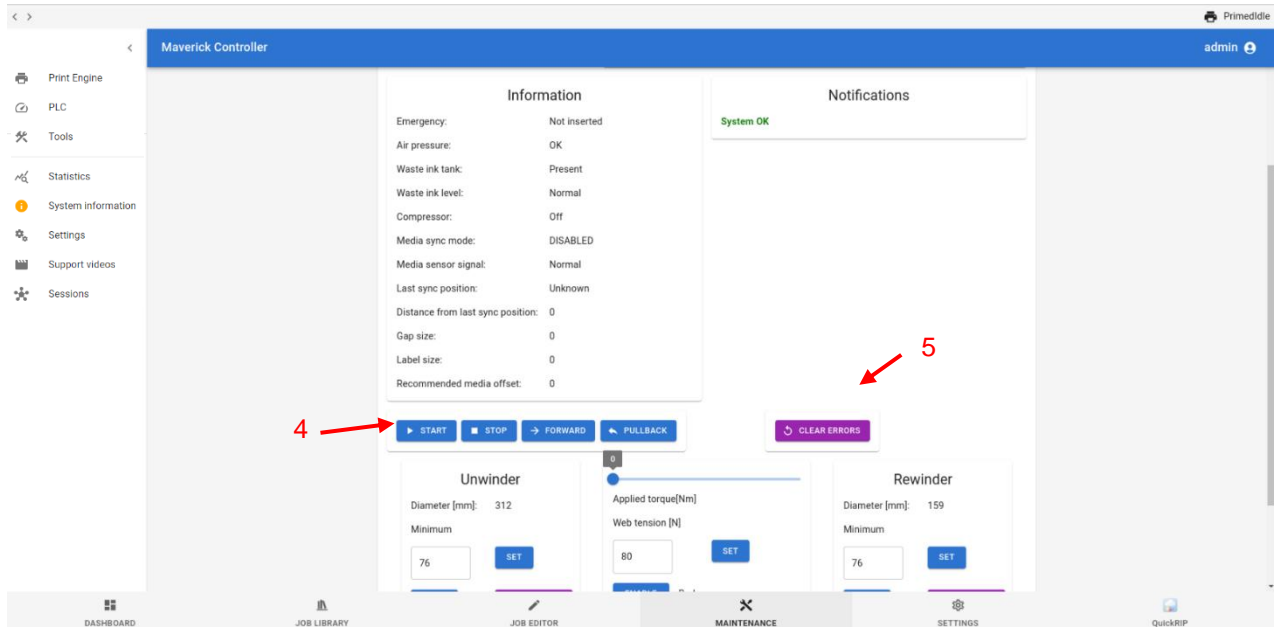

4. Manually move the material.
5. Clear any errors.

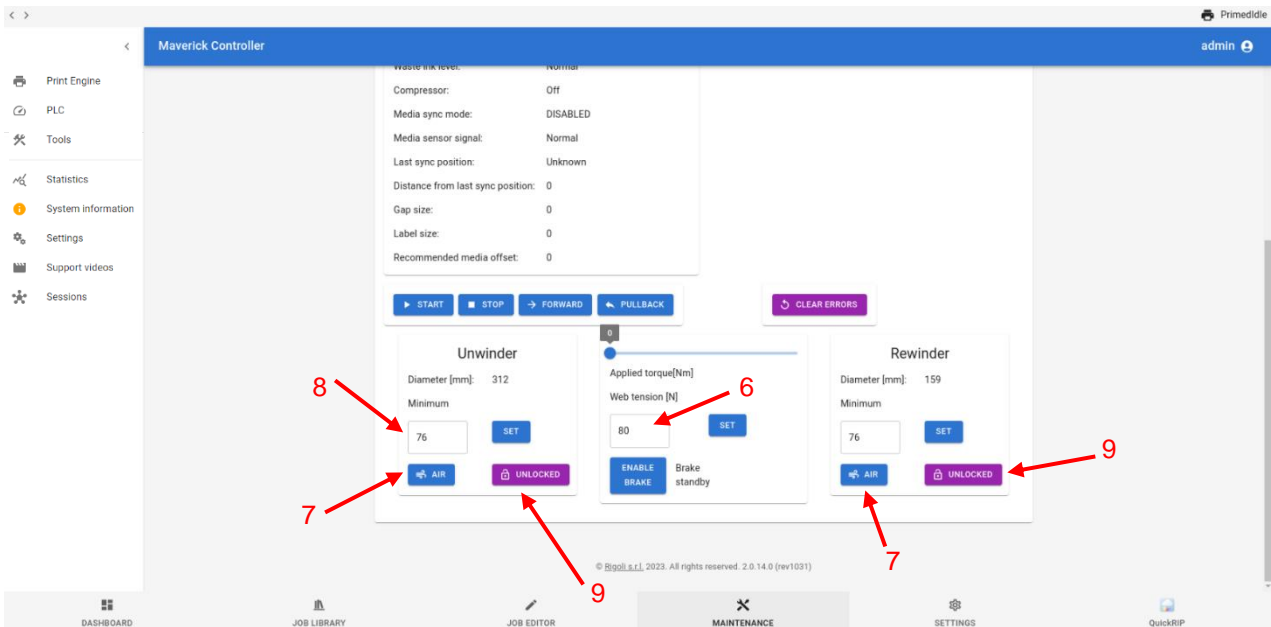

6. Set the web tension.
7. Apply air to the mandrels.
8. Set the minimum unwinder diameter.
9. Lock or unlock the mandrels.



## Tools

### Tools



**Send Test Email:** Will send a test email after the email settings have been configured.

**Create Test File on Samba Share:** Will create a test file once the Samba settings have been configured.

**Reload Job Library:** Will refresh the job library.

**Start Housekeeping Routine:** Used to clean up disk space on the printer.

**Sync Module Timezone:** Will sync the time zone set on the PC with the printer module.

**Sync Module Date and Time:** Will sync the date on time set on the PC with the printer module.

## Statistics

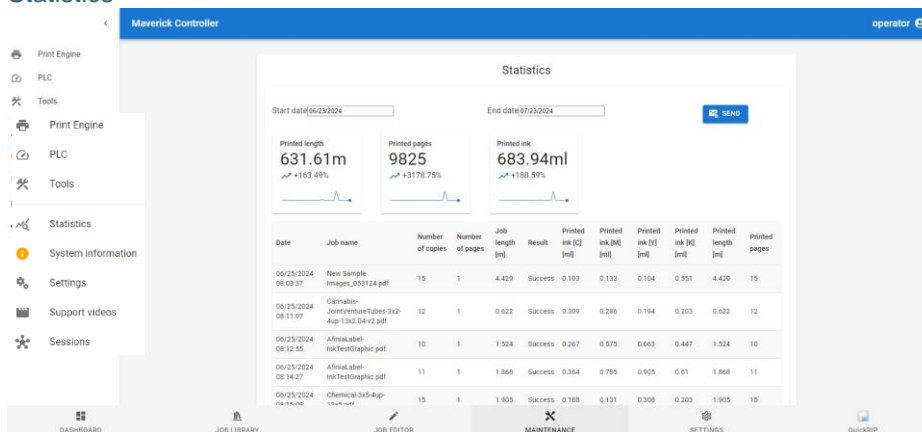

## System Information

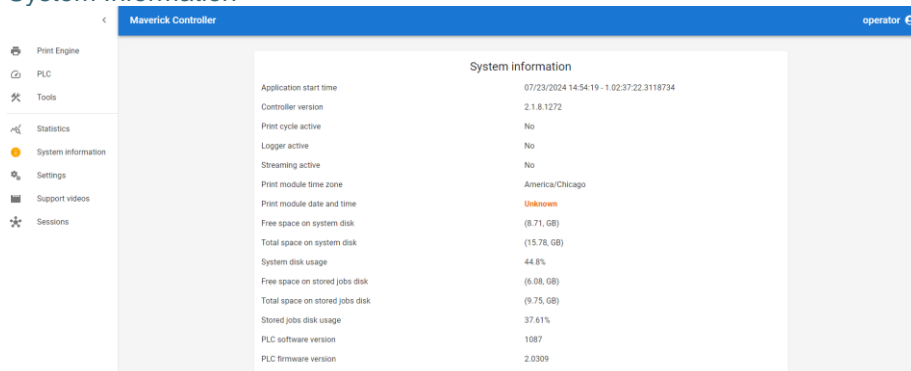

Displays build version information and disc usage.

Settings

Operator Login Settings:

Settings Panel

SET

RESET

**Section #APPSETTINGS**

Print until jobs are queued	The printer will automatically restart printing until the print queue gets empty.	<input checked="" type="checkbox"/>	
Mid-job service pagecount trigger	Pages printed before mid-job servicing is required. Optional. If set to zero, mid-job servicing will not be triggered by page count.	<input type="text" value="0"/>	SET
Mid-job service length trigger [m]	Media length printed before mid-job servicing is required. Optional. If set to zero, mid-job servicing will not be triggered by media length printed.	<input type="text" value="0"/>	SET
Use antistatic bar	Enabling/Disabling the usage of the antistatic bar (if installed).	<input type="checkbox"/>	
Use metrics	Choice between metrics or imperial systems.	<input checked="" type="checkbox"/>	
Printer identifier	The unique identifier of the printer.	Q9TU45	
Language	Selected language for the UI.	English ▾	
Cutter enabled	Enable/disable the cutter. With the cutter enabled, reverse movements are prohibited.	<input type="checkbox"/>	
Minimum Roll A diameter [mm]	The minimum roll diameter for Roll A. Once this diameter is reached, the unit will pause printing. 0 disables this feature.	<input type="text" value="0"/>	SET
Maximum Roll B diameter [mm]	The maximum roll diameter for Roll B. Once this diameter is reached, the unit will pause printing. 0 disables this feature.	<input type="text" value="0"/>	SET
Performance mode	The printer will automatically set the speed to the highest based on the printjob resolution.	<input checked="" type="checkbox"/>	

## Admin Login Settings:

Light clean before print	Before a print session the printer will automatically do a light clean.	<input type="checkbox"/>	
Air before movement start	Before media movement the printer will inflate the winder shafts.	<input type="checkbox"/>	
Use antistatic bar	Enabling/Disabling the usage of the antistatic bar (if installed).	<input type="checkbox"/>	
Spit-in-Flight	Enable/disable Spit-in-Flight mode.	<input checked="" type="checkbox"/>	
Use metrics	Choice between metrics or imperial systems.	<input type="checkbox"/>	
Printer identifier	The unique identifier of the printer.	7B4BA3	
Recovery after idle minutes	This parameter sets the idle time between successive print sessions, that won't trigger a light clean before the printing. Zero disables this function.	<input type="text" value="180"/>	<input type="button" value="SET"/>
Media type check length limit [mm]	Set the distance for the media type checking function. Zero disables this function.	<input type="text" value="1000"/>	<input type="button" value="SET"/>
Cutter installed	Sets if the cutter unit is installed to the printer.	<input type="checkbox"/>	
Report interval (days)	Set the report generation interval in days. Zero means off.	<input type="text" value="0"/>	<input type="button" value="SET"/>
Error notifications	Email notification if the unit enters into erroneous state.	<input type="checkbox"/>	

Light clean before print	Before a print session the printer will automatically do a light clean.	<input type="checkbox"/>	
Air before movement start	Before media movement the printer will inflate the winder shafts.	<input type="checkbox"/>	
Use antistatic bar	Enabling/Disabling the usage of the antistatic bar (if installed).	<input type="checkbox"/>	
Print module auto start-stop	Turning this feature on will automatically start the initialization or shutdown process of the print engine when the system booted up or properly commanded to shut down.	<input checked="" type="checkbox"/>	
Module fault recovery	Enabling this feature will shut down and reinitialize the module after FAULT state.	<input checked="" type="checkbox"/>	
Maximum fault recovery attempts	Maximum number of trials for fault recovery. Resets after one hour.	<input type="text" value="1"/>	<input type="button" value="SET"/>
Spit-in-Flight	Enable/disable Spit-in-Flight mode.	<input checked="" type="checkbox"/>	
Use metrics	Choice between metrics or imperial systems.	<input checked="" type="checkbox"/>	
Printer identifier	The unique identifier of the printer.	Q9TU45	
Recovery after idle minutes	This parameter sets the idle time between successive print sessions, that won't trigger a light clean before the printing. Zero disables this function.	<input type="text" value="180"/>	<input type="button" value="SET"/>
Cutter installed	Sets if the cutter unit is installed to the printer.	<input checked="" type="checkbox"/>	
Report interval (days)	Set the report generation interval in days. Zero means off.	<input type="text" value="1"/>	<input type="button" value="SET"/>

Error notifications	Email notification if the unit enters into erroneous state.	<input checked="" type="checkbox"/>
Enable/disable file reports	If enabled the reports are saved to the specified share. See samba settings.	<input type="checkbox"/>
Enable/disable email reports	If enabled the reports are sent to the specified email addresses. See email settings.	<input checked="" type="checkbox"/>
Report format	Set the report format to a specific version.	1.0.1 ▾
Samba domain	Sets the domain name for the Samba connection. Can be left blank.	microboards
Samba username	The username for the Samba connection.	microremote
Samba password	Password for the Samba connection.	..... .....
Samba IP address	The IP address of the Samba server.	192.168.10.24
Samba share name	The name of the Samba share.	Logs_IP120
Samba report path	The relative path to the folder in the Samba share, where the reports should be stored.	
Email sender name	The name that will appear as the sender.	X350 Mailer
SMTP server	The SMTP server name or IP address.	smtp.office365.com
SMTP Port	Port number for the SMTP server.	587 <input type="button" value="SET"/>
SMTP username	The username for the SMTP authentication if needed.	bradm@afinia.com
SMTP password	The password for the SMTP authentication if needed.	..... .....
Report recipient(s)	The email address(es) of the report recipient(s). Multiple addresses should be separated with comma.	bradm@afinia.com,rishia
Error notification recipient(s)	The email address(es) of the error notification recipient(s). Multiple addresses should be separated with comma.	bradm@afinia.com,rishia
Report BCC recipient(s)	The email address(es) of the report BCC recipient(s). Multiple addresses should be separated with comma.	
Error notification BCC recipient(s)	The email address(es) of the error notification BCC recipient(s). Multiple addresses should be separated with comma.	

SMTP security	Security option for the SMTP communication.	StartTls ▾	
CSV separator	The separation character in the CSV reports.	,	
Language	Selected language for the UI.	English ▾	
Timezone	Selected timezone.	(UTC-06:00) Central Time (Chicago) ▾	
Date pattern	Set the date pattern for UI and statistics. The statistics report's ISO 8601 format won't be affected.	01/02/2000 ▾	
Time pattern	Set the time pattern for UI and statistics. The statistics report's ISO 8601 format won't be affected.	12:34:56 ▾	
Cutter enabled	Enable/disable the cutter. With the cutter enabled, reverse movements are prohibited.	<input type="checkbox"/>	
Web tensioning distance	Sets the distance in mm of movement used to tension the web. Zero disables this function.	25	<b>SET</b>
Media sensor light	Set this option to ON if the media sensor light turns on when a label (not the gap) is under the sensor.	<input type="checkbox"/>	
Minimum Roll A diameter [mm]	The minimum roll diameter for Roll A. Once this diameter is reached, the unit will pause printing. 0 disables this feature.	0	<b>SET</b>
Maximum Roll B diameter [mm]	The maximum roll diameter for Roll B. Once this diameter is reached, the unit will pause printing. 0 disables this feature.	0	<b>SET</b>
Performance mode	The printer will automatically set the speed to the highest based on the printjob resolution.	<input checked="" type="checkbox"/>	
Days to keep unused stored jobs.	Sets the number of days to keep unused jobs stored in the main job library. Zero disables this feature.	0	<b>SET</b>

Section #HWPARAMETERS

Low ink percentage	Set the percentage limit that should trigger to ink low warning	<input type="text" value="5"/>	<input type="button" value="SET"/>
Interpage spit bar height - cyan	Sets the number of cyan rows printed in the interpage spit bar.	<input type="text" value="0"/>	<input type="button" value="SET"/>
Interpage spit bar height - magenta	Sets the number of magenta rows printed in the interpage spit bar.	<input type="text" value="0"/>	<input type="button" value="SET"/>
Interpage spit bar height - yellow	Sets the number of yellow rows printed in the interpage spit bar.	<input type="text" value="0"/>	<input type="button" value="SET"/>
Interpage spit bar height - black	Sets the number of black rows printed in the interpage spit bar.	<input type="text" value="0"/>	<input type="button" value="SET"/>
Encoder ticks per inch	Encoder rate in ticks per inch. This is the number of positive transitions on a single encoder input which corresponds to the media moving by one inch.	<input type="text" value="1352"/>	<input type="button" value="SET"/>
Media sensor polarity	Set the media sensor working mode. If the media sensor light is on when the gap/blackmark is read, set it to Normal. If the light is on when the label is read, turn to Inverted.	<input type="text" value="normal"/>	

Section #USERSETTINGS

Password	Set password for user: operator	<input type="text"/>	<input type="text"/>
Password	Set password for user: admin	<input type="text"/>	<input type="text"/>

Media pullback after print: Enabling this feature will save media by pulling back to the point where the last print finished.

Job chaining: With job chaining enabled the printer will try to print multiple jobs in the same printing session. Jobs need to have the same resolution and width to be chained.

Print until jobs are queued: The printer will automatically restart printing until the print queue is empty.

Mid-job service pagecount trigger: Pages printed before mid-job servicing is required.

Mid-job service length trigger [m]: Media length printed before mid-job servicing is required. Value in meters.

Allow interpage ejections: Enabling/disabling ink ejections (KWS, spit bars) to interpage area.

Ink Cost: Cost per liter of ink.

Light clean before print: Before a print session the printer will automatically do a light clean.

Air before movement start: Before media movement the printer will inflate the winder shafts.

Use antistatic bar: Enabling/Disabling the usage of the antistatic bar (if installed).

Print module auto start-stop: Turning this feature on will automatically start the initialization or shutdown process of the print engine when the system booted up or properly commanded to shut down.

Module fault recovery: Enabling this feature will shut down and reinitialize the module after FAULT state.

Maximum fault recovery attempts: Maximum number of trials for fault recovery. Resets after one hour.

Spit-in-Flight: Enable/disable Spit-in-Flight mode.

Use metrics: Choice between metrics or imperial systems.

Printer identifier: Unique identifier for the printer.

Cutter installed: Sets if the cutter unit is installed in the printer.

Report interval (days): Sets the report generation interval in days.

Error notifications: Email notification if the unit enters an error state.

Enable/disable file reports: If enabled, the reports are saved to the specified share.

Enable/disable email reports: If enabled, the reports are sent to the specified email.

Report format: Sets the report format to a specific version.

Samba settings: Used to configure the location of the reports on the local network.

Email report frequency: How many days should the system send the email reports. 0 means the feature is off.

Recovery after idle minutes: This parameter sets the idle time between successive print sessions, that won't trigger a light clean before the printing. Zero disables this function.

Media type check length limit [mm]: Set the distance for the media type checking function. Zero disables this function.

Email sender name: The name that will appear as the sender.

SMTP server: The SMTP server name or IP address.

SMTP Port: Port number for the SMTP server.

SMTP username: The username for the SMTP authentication if needed.

SMTP password: The password for the SMTP authentication if needed.

Report recipient(s): The email address(es) of the report recipient(s). Multiple addresses should be separated with commas.

Error notification recipient(s): The email address(es) of the error notification recipient(s). Multiple addresses should be separated with commas.

Report BCC recipient(s): The email address(es) of the report BCC recipient(s). Multiple addresses should be separated with commas.

Error notification BCC recipient(s): The email address(es) of the error notification BCC recipient(s). Multiple addresses should be separated with commas.

SMTP security: Security option for SMTP communication.

CSV separator: The separation character in the CSV reports.

Language: Sets the language for the UI.

Timezone: Sets the time zone for the printer's location.

Date pattern: Sets the date pattern for the UI and statistics.

Time pattern: Sets the time pattern for the UI and statistics.

Cutter enabled: Enable/disable the cutter.

Web tensioning distance: Sets the distance in mm of the movement used to tension the web.

Media sensor light: Set this option to ON if the media sensor light turns on when a label is under the sensor.

Minimum Roll A diameter: The minimum roll diameter for Roll A (unwind).

Maximum Roll B diameter: The maximum roll diameter for Roll B (rewind).

Performance mode: The printer will automatically set the speed to the highest based on the print job resolution.

Days to keep unused stored jobs: Sets the number of days to keep unused jobs stored in the mail job library.

### HWPParameters

Low ink percentage: Sets the percentage limit that should trigger a low ink warning.

Interpage spit bar height: Sets the number of rows each color will print in the interpage spit bar.

Encoder ticks per inch: Encoder rate in ticks per inch. Set and the factory and should not be changed.



Media sensor polarity: Sets the media sensor working mode.

## USERSETTINGS

Password: Allows the password change for the operator and admin users.

## Support Videos

Link to support videos found on the Afinia Label website.

## Sessions

Sessions				
User type	Connection type	IP address	Socket.IO	Latency
IFRAME	Local	10.249.16.1	Ig427xEwgN9uel6kAAAC	1
UNKNOWN	Local	10.249.16.1	a1z4uA6E-20igTU0AAAD	1
IFRAME	Remote	192.168.10.110	IHomHq9znCBPLeONAAAF	1
ADMINISTRATOR	Local	192.168.10.110	jW_x9_0MJfehSM7xAAAe	1

Displays a list of the active sessions for the printer.

## Settings

The screenshot shows the 'Settings' page for a printer, specifically the network configuration section. The page is titled 'Primedrive' in the top right corner. On the left, there is a sidebar with navigation options: NETWORK, INTERFACE, Frame, and LOG. The main content area is divided into three panels: 'Internet interface', 'Printer interface', and 'Engine interface'. Each panel displays the status and configuration for that interface. The 'Internet interface' panel shows IP address: 192.168.0.26, Netmask: 255.255.255.0, Default gateway: 192.168.0.254, Primary DNS: 127.0.0.53, and Secondary DNS: 8.8.4.4. The 'Printer interface' panel shows IP address: 192.168.100.2, Netmask: 255.255.255.0. The 'Engine interface' panel shows IP address: 192.168.111.2, Netmask: 255.255.255.0. Each panel has a 'SAVE CHANGES' button at the bottom right. At the bottom of the page, there is a navigation bar with icons for DASHBOARD, JOB LIBRARY, JOB EDITOR, MAINTENANCE, SETTINGS (which is currently selected), and QuickRIP.

Network details shown here.

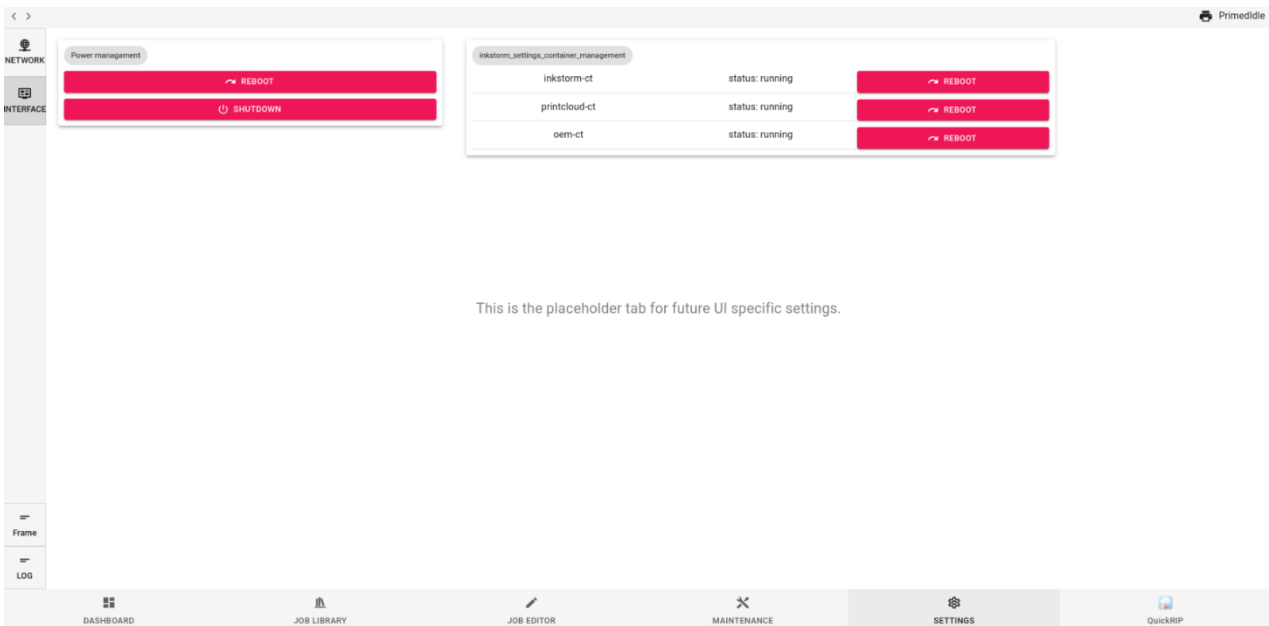

Interface screen allows for the reboot or shutdown of the computer. Also, the individual modules can be restarted.

## QuickRIP

The image below provides a visual representation of the user interface, which is how you can interact with the product. The interface is designed to be intuitive and easy to use with various components. In the following section, we will dive deeper into these components and provide insight into how they operate. By understanding the functions and behaviors of these components, users can learn how to efficiently use the system and achieve their intended goals with ease.

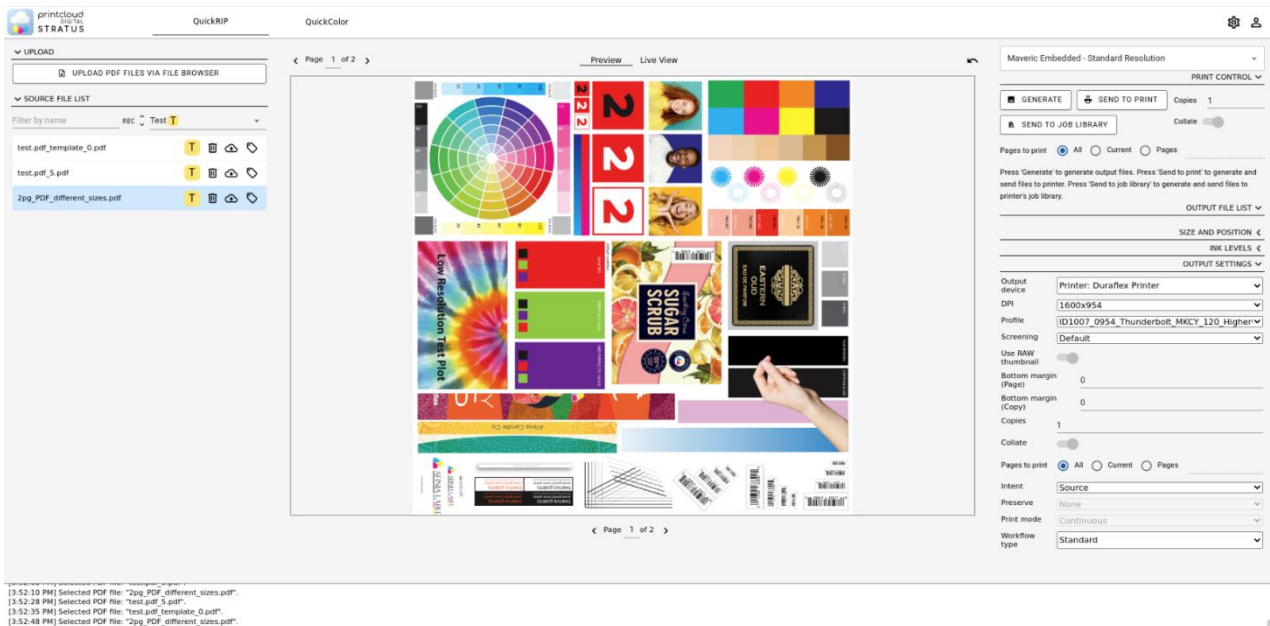

### Upload & Source files

In this section you can conveniently interact with your files by uploading, downloading, deleting, and organizing them. You can also see the preview and live view of the image that is currently chosen and manage your printer settings to ensure your documents are printed in the right format and quality.

Even though the interface is designed to be convenient to use, upon first look it may appear to be quite a lot to handle. For ease of understanding, let us break it down into three main parts to better explain them.

In this part of the interface, you have the option to upload your files through two different methods: either by using the file browser or by easily dragging and dropping them into the designated area.

Once you have uploaded your file, it will appear in the source file list section. A message will inform you that your file is currently undergoing a generation process. Once this process is complete, your file will be ready for use.

Now, let's direct our focus to the marked areas of the image and take a closer look at them.

**1:** You can filter your uploaded files by sorting them in various ways, such as by ABC order, last uploaded, last edited or assigned labels. To switch between these options, simply click on the designated area and the sorting will be applied instantly. This feature can be incredibly useful for finding specific files quickly and efficiently, depending on your needs.

**2:** You can assign one or more labels to each file, providing a customizable way to organize and categorize your files. If you don't have any available labels, please refer to [settings](#) section.

**3:** These icons allow you to interact with the file in different ways. For instance, if you want to remove the file, you can simply click on the delete icon, and the file will be removed from your system. In that case, there will be a short period of time in which you can undo the action in case you change your mind. Similarly, if you want to save the file on your device, you can use the download icon.

In addition, you can also use the available label(s) to categorize the files. This can be helpful in organizing and managing files on your system. You can assign a label to a file that describes its content, type, or any other information you like. By doing so, you can quickly search and locate files based on their labels, which can save you a lot of time and effort.

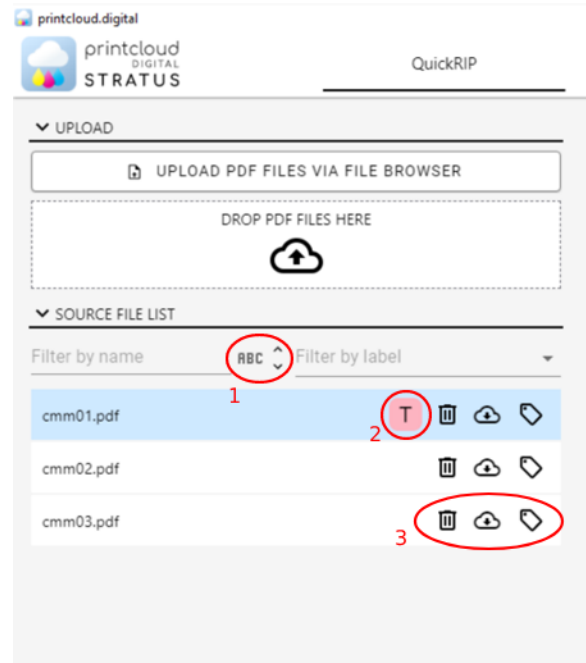

## Preview and Live View



You are provided with a *Preview* section that offers you the ability to confirm that you are working on the intended file before printing, providing an extra layer of assurance. This view can also be utilized to quickly check adjustments made to the position, rotation, and scale of the file.

In addition to the preview section, you also have access to a *Live View* feature which displays a real-time representation of how your document will appear once printed. This allows you to make any necessary adjustments and ensure that the final print is up to par with your expectations. It is important to keep in mind, however, that the *Live View* requires processing time to update any adjustments that have been made. As a result, it may take a little longer to see the changes reflected in the *Live View*.

By default, if no changes are made to the output configuration, the differences between the preview and live view may be minimal, if at all noticeable. However, it is important to keep in mind that with different output settings, the variations between the preview and live view can be quite significant. Therefore, it is recommended to utilize the live view feature when making any adjustments to the output settings to ensure that the final print matches your desired outcome.

In the images below, you can observe the distinctions between the preview (on the left), the live view without any alterations (in the center), and ultimately the live view after modifications were made to the ink levels and output settings (on the right).



## Output configurations, print control and settings

In this section, you are given the flexibility to select your printer's output configuration to ensure that your document is printed to your exact specifications.

Within this part of the interface, you can customize various aspects of the output generated by the system. This includes control over the processing and printing stage, such as adjusting the layout, size or ink levels. Additionally, users can configure the output file to meet their specific needs, e.g.: choosing the file format or setting the resolution.

Rest assured that any changes you make are automatically saved to the file you are working on. Therefore, you do not have to worry about having to reset these settings the next time you print.

Now, let's begin a thorough examination of every option featured in this specific section of the product, starting with the submenu dedicated to print control.

### Print control

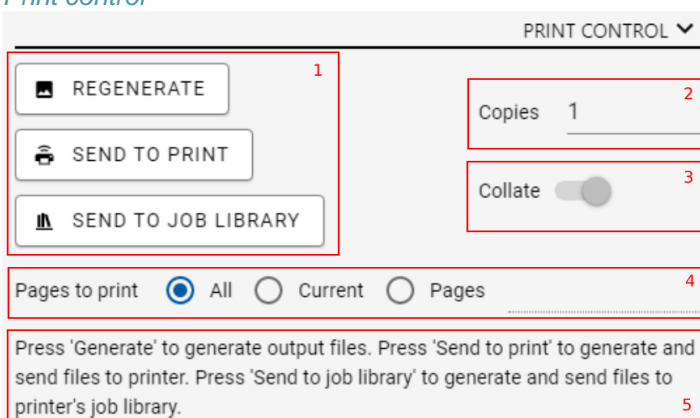

**1:** By utilizing the marked buttons, you can generate output files and subsequently select a preferred destination, be it the printer or its job library. It is important to bear in mind, however, that certain output devices or methods may not support these options, resulting in their unavailability. For instance, choosing the output to be a PDF File might preclude the option to send it to the printer.

**2:** You can enter the desired number of copies in the text field below

**3:** To ensure your printed pages are in order when printing multiple copies, simply enable the collate option. This convenient feature arranges the pages in the correct sequence, saving you time and effort in manual sorting.

**4:** When you are working with a file that contains multiple pages, you may only want to process specific pages. In this case, you can specify which pages you would like to be processed.

**5:** A general description to assist you in understanding the functions of the buttons mentioned in the first point.

After the successful generation of the file, the resulting output will be made accessible in this section. This section serves as a repository for all the files generated during the process, and users can easily access their files by navigating to this section. It is important to note that the availability of the output file is dependent on the successful completion of the generation process, and any errors encountered during the process may result in a delay or failure of the file being made available.

Upon completion of the file generation process, you will have several options available to you. You can choose to manually send the file(s) to the printer (🖨️) or its job library (📁), delete the file(s) entirely, or download (📄) the file(s) to your device for further use.

### Size and position

**1:** You have the capability to adjust the position of the file that is waiting to be printed by a specific amount which you are free to change. By looking at the *Preview* section or the *X/Y-offset* values in the box next to this panel (labeled as number 7), you can monitor how the image's position is being altered.

**2:** By utilizing these buttons, you can align the image completely to the left, right, or center, with ease.

**3:** By utilizing these buttons, you can easily rotate the image either 90 degrees to the left or right, or 180 degrees, and observe the changes in the *Preview* section or the at the *Rotation* value in the box next to this panel (labeled as number 7).

**4:** You have the capability to adjust the scale of the file that is waiting to be printed by a specific amount which you are free to change. By looking at the *Preview* section or the *Width / Height* values in the box next to this panel (labeled as number 7), you can monitor how the image is being altered.

**5:** With the help of these buttons, you can change how the image is fit inside its borders

**6:** With the use of this toggle button, you have the option to switch between displaying the values in millimeters or inches, according to your preference.

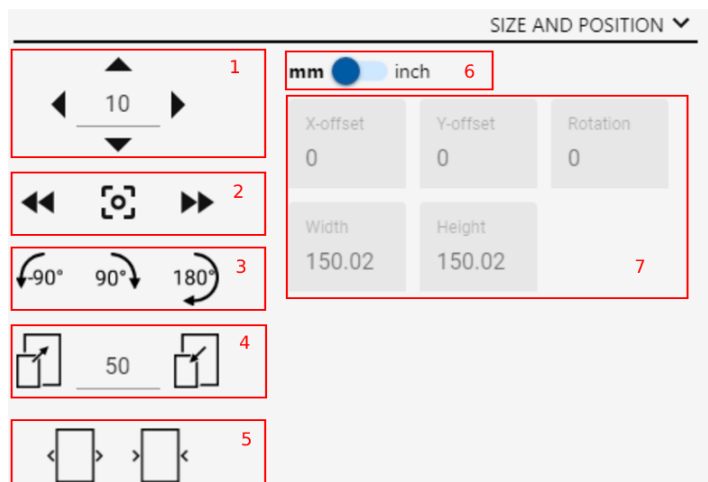

**7:** The values presented offer information on the adjustments made to the image's position, rotation, or scale, allowing you to keep track of any modifications made.

### *Ink levels*

With these sliders, you can finely tune the ink usage of your printer for the specific file being printed. Any adjustments you make can be previewed in real time within the *Live* section. You have the freedom to adjust the sliders manually or make more precise adjustments using the buttons located at both ends of the slider.

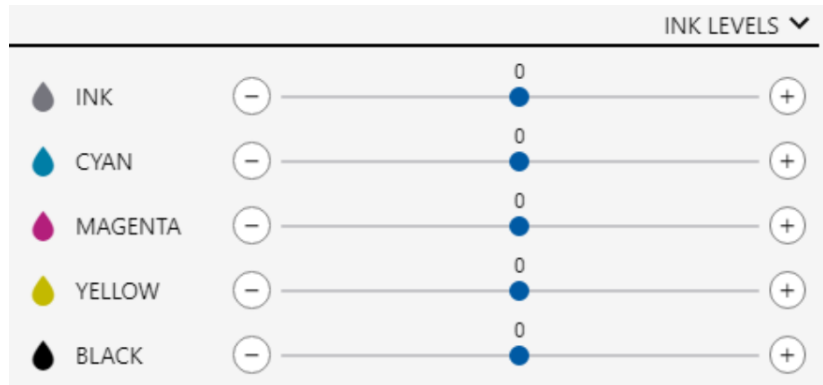

If you prefer to adjust all colors simultaneously by the same amount, you can easily achieve this by using the topmost slider. This slider enables you to set a single value that will be applied across all color channels, ensuring consistent adjustments across the board.

You can examine the contrast between these two images by comparing them directly. The image on the left exhibits ink levels set to -100, while the image on the right showcases levels set to +100.



### *Output settings*

Within this section, you have the capability to modify the output settings according to your printing needs. This includes selecting the appropriate output devices, specifying their respective resolutions, determining the printing profile to be utilized etc.

Please note that certain attributes, such as the number of copies or specific pages to be printed, may have already been adjusted because of changes made within the Print Control section.

In the upcoming section, we will delve into the concepts of intents, preserve mode, and print mode, in order to gain a deeper understanding of these settings.

### Intents

When printing an image or document, you can choose from a variety of "intent" settings that determine how the colors in the file are interpreted and reproduced on paper. Currently, the intent option includes:

**Source:** This setting uses the original color profile of the image or document being printed and does not adjust the colors to fit a specific printer profile. It's a good choice for high-quality images where color accuracy is important.

**Perceptual:** This setting adjusts the colors to fit within the color gamut of the printer while maintaining the overall appearance of the image. It aims to preserve the visual relationship between colors and is often used for printing photographic images.

**Colorimetric Relative:** This setting maps the colors from the source profile to the printer profile, aiming to preserve the colors in the image or document as closely as possible. However, it may cause colors to shift or clip if they fall outside of the printer's gamut.

**Saturation:** This setting enhances the intensity of colors in the image or document, resulting in colors appearing more vivid than they do on screen. It's often used for printing graphics or advertisements.

**Colorimetric Absolute:** This setting is similar to colorimetric relative, but it does not attempt to adjust the colors to fit within the gamut of the printer. Instead, it aims to preserve the color values as closely as possible, even if this results in colors being outside of the printer's gamut. It's a good choice for printing high-end graphics where color accuracy is paramount.

### Preserve

When selecting certain intents for printing, there are additional options that can be chosen to further refine the color output. One of these options is "preserve," which determines how the printer handles out-of-gamut colors that cannot be reproduced accurately.

The preserve option includes:

**None:** This setting allows the printer to adjust the colors freely, without attempting to preserve any specific out-of-gamut colors. This can result in more accurate overall color reproduction but may also cause some colors to appear slightly different from the original.

**Black:** This setting instructs the printer to preserve any out-of-gamut colors by replacing them with black. This can be a good option for printing images with rich, dark colors, as it can help maintain the overall tone and contrast of the image.

OUTPUT SETTINGS	
Output device	Printer: Duraflex Printer
DPI	1600x954
Profile	ID1007_0954_Thunderbolt_MKCY_120_Highe
Screening	Default
Use RAW thumbnail	<input checked="" type="checkbox"/>
Bottom margin (Page)	0
Bottom margin (Copy)	0
Copies	1
Collate	<input checked="" type="checkbox"/>
Pages to print	<input checked="" type="radio"/> All <input type="radio"/> Current <input type="radio"/> Pages
Intent	Source
Preserve	None
Print mode	Continuous
Workflow type	Standard



**Black Plane:** This setting is like "black," but instead of replacing out-of-gamut colors with solid black, it uses a halftone pattern to simulate the missing colors. This can be a good option for printing images with smooth gradients or subtle color variations, as it can help avoid banding or other printing artifacts.

### Log

```
[4:49:46 PM] Started to processing PDF file "2pg_PDF_different_sizes.pdf" with configuration "Maveric Embedded - Standard Resolution".  
[4:49:48 PM] RAW Image generated.  
[4:49:48 PM] Stream file successfully generated.  
[4:49:48 PM] Successfully processed PDF file "2pg_PDF_different_sizes.pdf" with configuration "Maveric Embedded - Standard Resolution".
```

Located at the bottom of the application is the log, which serves as a valuable source of information regarding ongoing processes. By providing useful updates and notifications, the log enables you to keep track of background operations such as generating or printing a file, allowing you to monitor progress and identify any potential issues that may arise.

### Settings

To access the application settings, simply click on the gear icon located in the upper right corner. This action will prompt the menu, which is displayed in the image below:

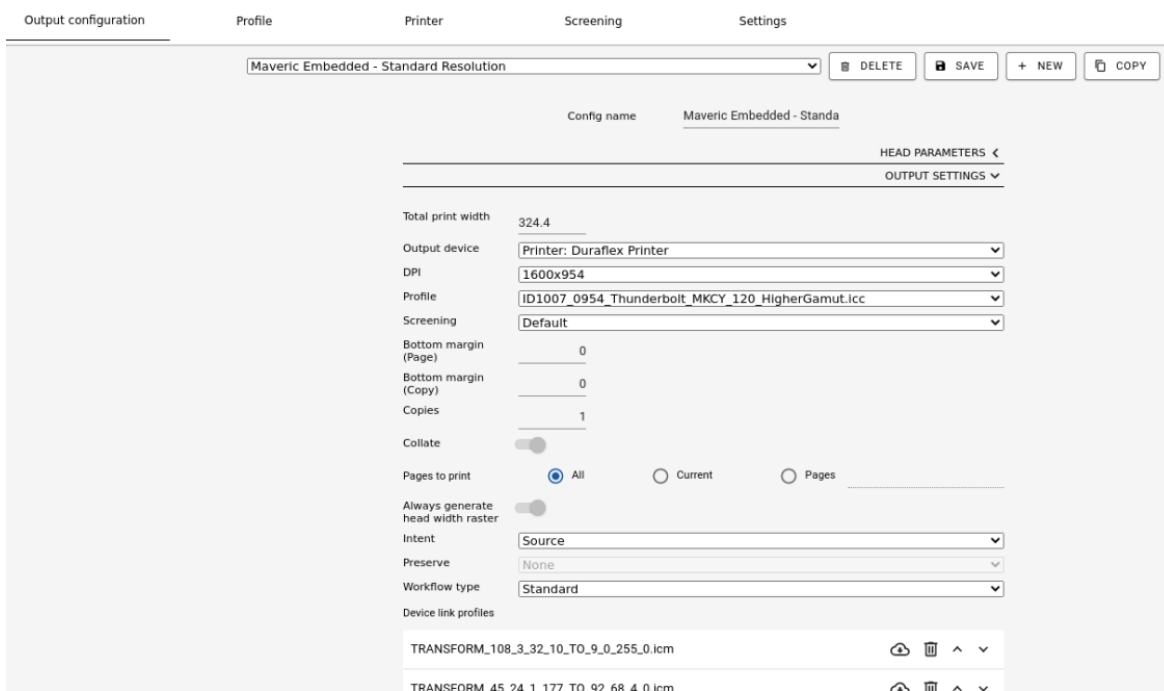

The Settings section is divided into four distinct submenus: Output Configuration, Profile, Printer, Screening and Settings. Within each of these submenus, you'll find an array of settings that can be customized to suit your preferences and needs.

In the following four sections, we provide an in-depth look into the settings offered within each of these submenus.

## Output configuration

The output configuration tab houses the printer's output settings, allowing users to customize various options to achieve their desired output results. Let us explore the various options available. The key components of the user interface have been highlighted in red for easy identification in the image below:

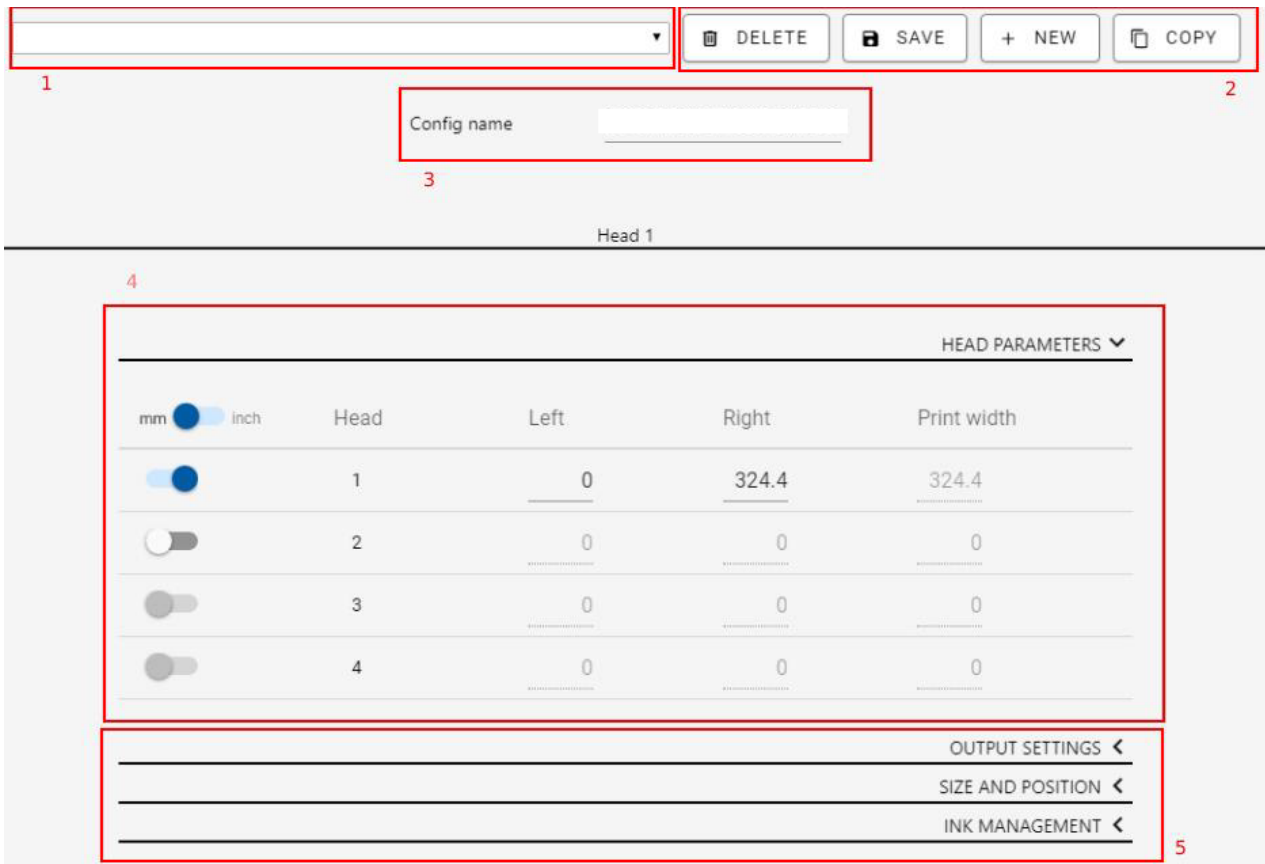

**1:** With selector, you can opt for the output configuration you would like to modify

**2:** These buttons provide you with the flexibility to perform various tasks, such as removing the existing output configuration, saving any alterations made to it, generating a brand-new configuration, or duplicating the settings of the current configuration to create a new one. If you click on the delete button, the current output configuration will be permanently removed. To prevent users from accidentally deleting configurations, by clicking the button an undo button will appear in place of the delete button. This button will have a three-second timeout period within which users can undo the deletion if required.

**3:** You can rename the current output configuration as per your preference.

**4:** This section is reserved for multi-head products and is not intended for the use of the X350.

**5:** The submenus present in this section are equivalent to the ones that were explained in sections [6](#), [7](#) and [8](#) of the previous chapter.

## Profile

With the profile settings feature, you can enhance your application by adding additional profiles through the uploading of your ICC or ICM files. This can be easily achieved by either clicking the designated upload button or by simply dragging and dropping the files into the assigned area. In addition, the uploaded profiles can be conveniently filtered using the filter field located at the top of the user interface. To further streamline the search process, the filtered results can also be sorted in either ascending or descending alphabetical order by simply clicking the arrows located on the right-hand side.

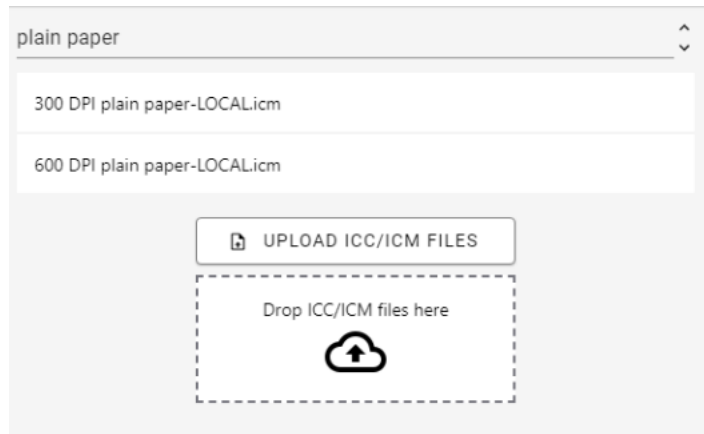

## Printer

In the printer section, you have a comprehensive view of all printers associated with the current instance. This allows you to easily monitor each printer's status and output format. Furthermore, you can customize the settings for each printer by renaming them and setting a new default IP address to better suit your specific needs. The functionality of the delete and save buttons should not be overlooked, as they offer the ability to either remove a printer's connection to the current instance or save any changes made to its settings.

## Settings

The final submenu pertains to the general settings of the application. Within this section of the user interface, you can select your preferred language and edit any labels as needed.

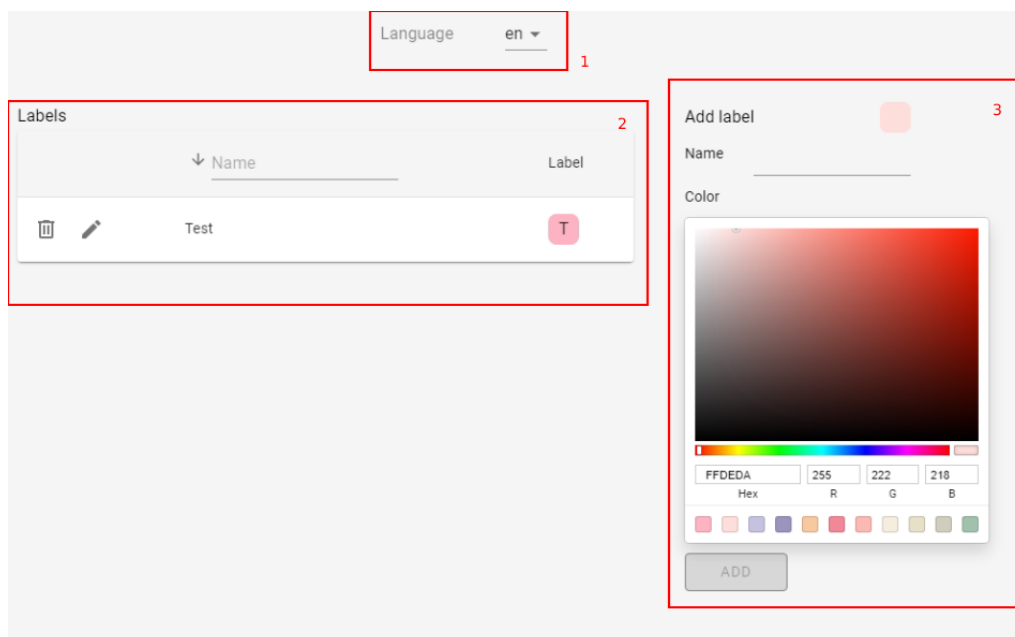

1: You have the option to select the language utilized for the user interface of the application.

2: In this section, you can conveniently access all currently available labels. From here, you have the ability to delete (🗑️) or modify (✏️) any label by simply clicking the corresponding icons. Additionally, the search and filter functions allow you to easily locate labels by name, and the alphabetical sorting feature can further streamline your search by organizing labels in either descending or ascending order.

3: In this section, you also can create new labels by specifying their name and assigning a color to them. Simply click the "Add" button to create the new label, which will immediately appear in the labels section (marked as No. 2). Please note that the "Add" button will remain disabled until a name is provided for the new label. While it is not required for label names to be unique, it is recommended to avoid any confusion.

## OPERATIONS

### Start of Day or Shift

Perform light or medium system maintenance before starting to use the printer.

### End of Day or Shift

1. Do not power off the printer at the end of the day.
2. Perform a light service and ensure the printhead is left in a capped position.

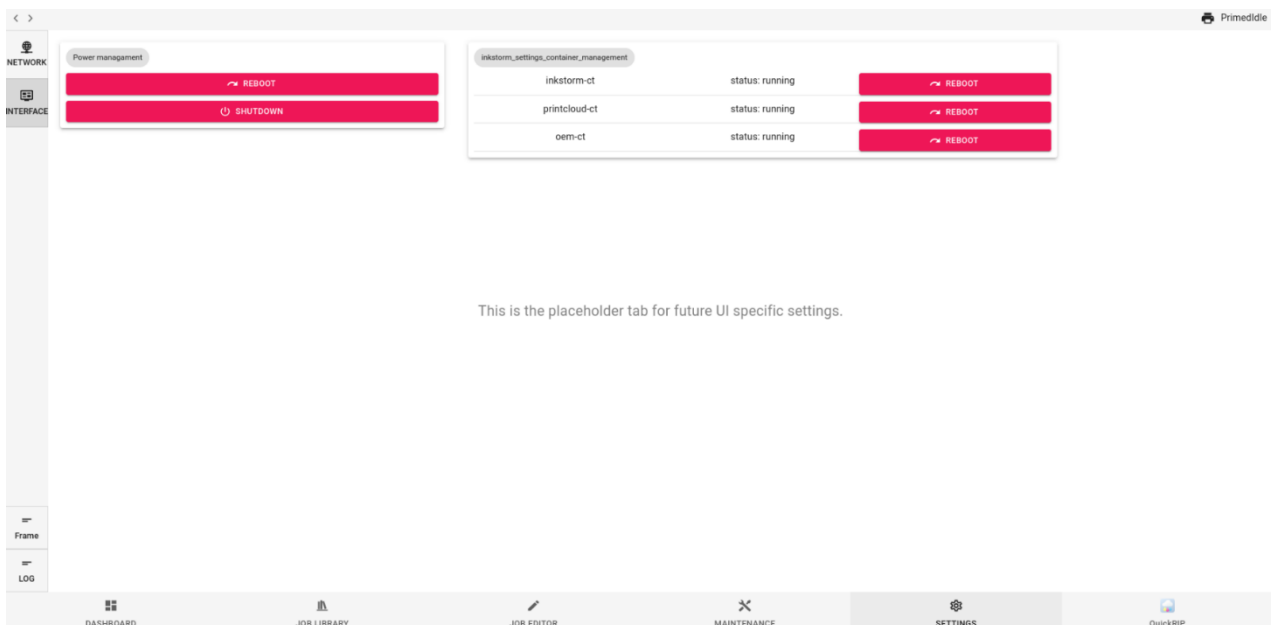

### Printhead Prime Confirmation

The system needs to be in **PRIMED\_IDLE** status prior to printing (or when not in use).

When the system is in the **PRIMED\_IDLE** status, it performs the following periodic maintenance tasks:

- Spits once every 2 hours

- Flushes once every 10 hours
- Performs a light service 15 minutes after the most recent print job
- Performs a 4-min printhead calibration flush routine once a week

If it reads **DEPRIMED\_IDLE**, the customer should perform priming, and the status will change to **PRIMED\_IDLE**.

Note: The system will not print or run periodic maintenance until it is successfully primed.

### Cap the Printhead

To avoid dehydration, the printhead should always be capped when not in use. During an error condition, the printhead can also be moved to the CAP position.

### Shut Down the Printer

Typically, the printer should not be shut down and should be kept running, but when shutdown is necessary.

### Pen-to-paper spacing (PPS) operations

In the following section the Pen-to-Paper Spacing related operations are described.



Warning: Risk of crushing hands.



Warning: Risk of damaging printer components.

To have the best print quality, the printhead nozzle array should be 0.7mm above the printable surface. The X350 supports media with thickness ranging from 0.05mm to 0.35mm, therefore, to achieve the best results with various media, the PPS should be regulated accordingly.

The X350 has a precise PPS regulation assembly that allows the operator to

- Manually adjust the PPS setting and lock to avoid accidental modifications.

- Quickly lower the spittoon holder to access the spittoon or to ease the loading of new material, without compromising the set PPS.

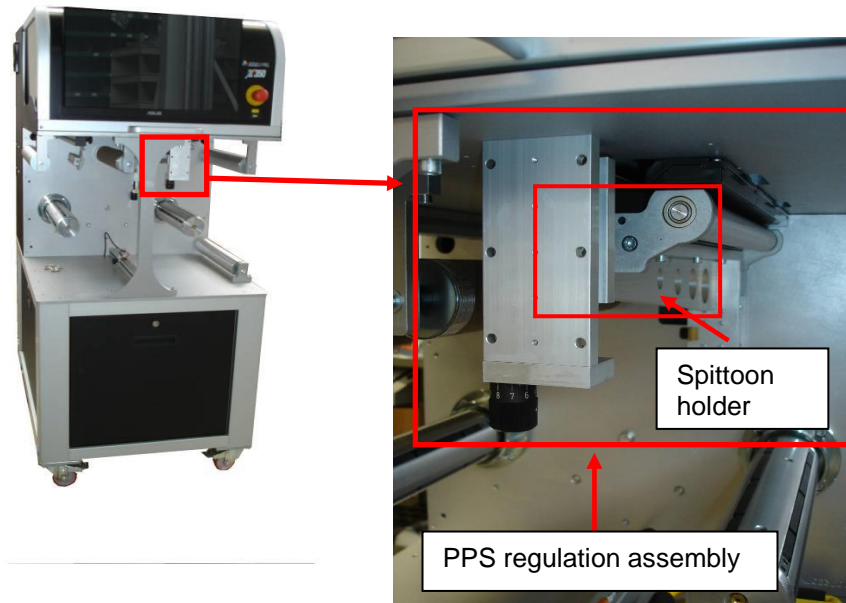

### PPS regulation

The PPS regulation assembly has two knobs on the sides. On the knob there is a numeric scale, and above each knob there is a reference marker. The position of the knobs could be fixed by tightening the grub screw above the knobs using a 2.5 Allen key.

To INCREASE the PPS (moving the printhead FURTHER from the media surface) the knobs should be turned counterclockwise.

To DECREASE the PPS (moving the printhead CLOSER to the media surface) the knobs should be turned clockwise.

Each number on the scale corresponds to 0.1mm vertical movement (one full turn is 1mm movement). The knobs should be turned simultaneously to avoid having the platen becoming not parallel with the printhead.

To prevent the spittoon platen touching the printhead, there are physical blocks at the upmost position, which keeps the platen 0.2mm away from the printhead.

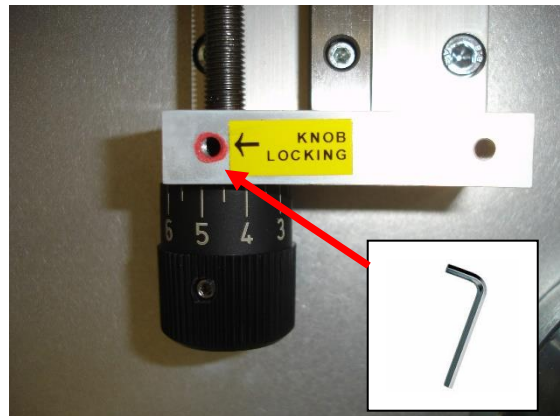
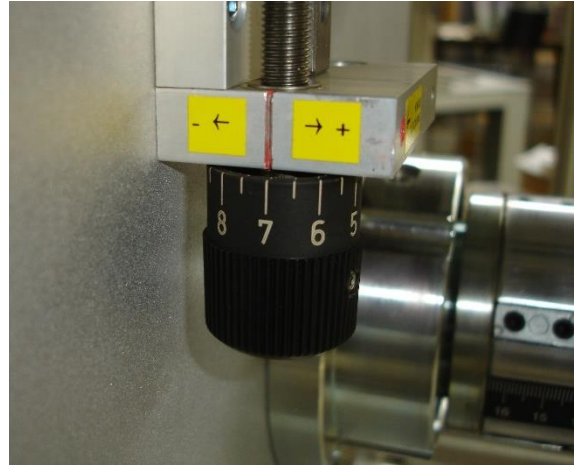
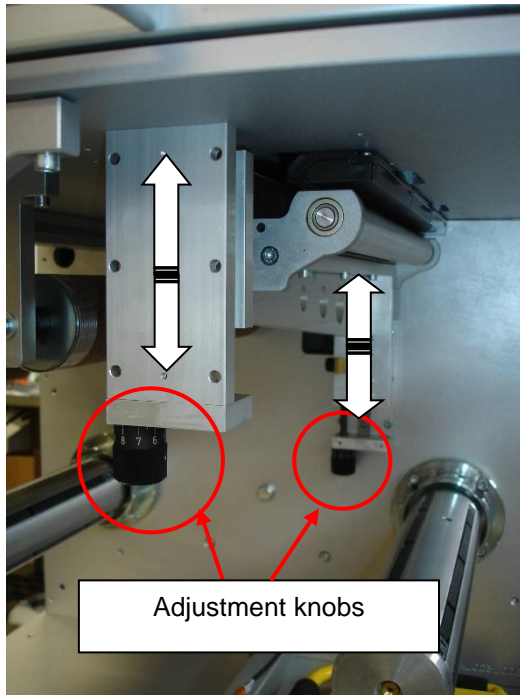

Once the desired PPS is set, tighten the grub screw to hold the knob position.

Example:

Printhead to spittoon platen distance is 0.7mm

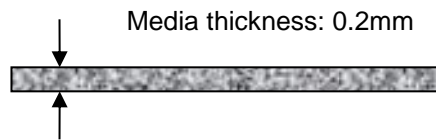
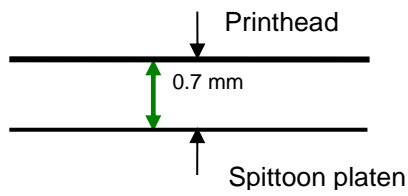

Knob set to 7

Setting the new PPS to have the recommended 0.7mm distance.

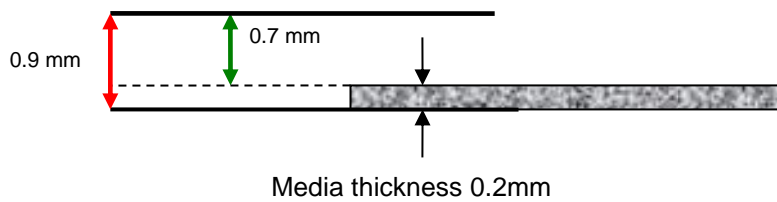

Set the knobs to 9

### Quick release of the spittoon assembly

The PPS regulation assembly has two brass hinges for quick releasing the spittoon assembly to the lowest position. This is recommended when

- A new media roll is loaded to the system,
- Accessing the Aerosol Extraction System module,
- Accessing the spittoon.

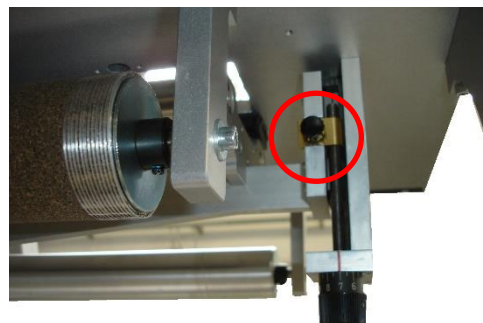
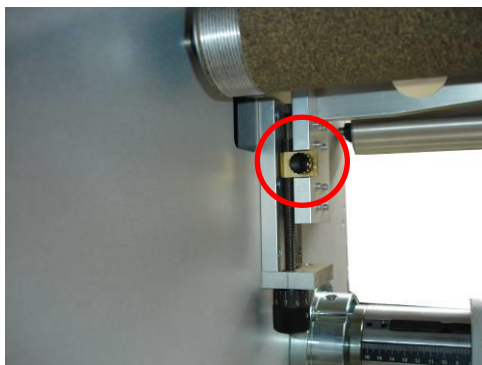

1. Remove the fixing screws from the hinges.
2. Hold the spittoon assembly from the bottom.





3. Open the hinges on both sides.

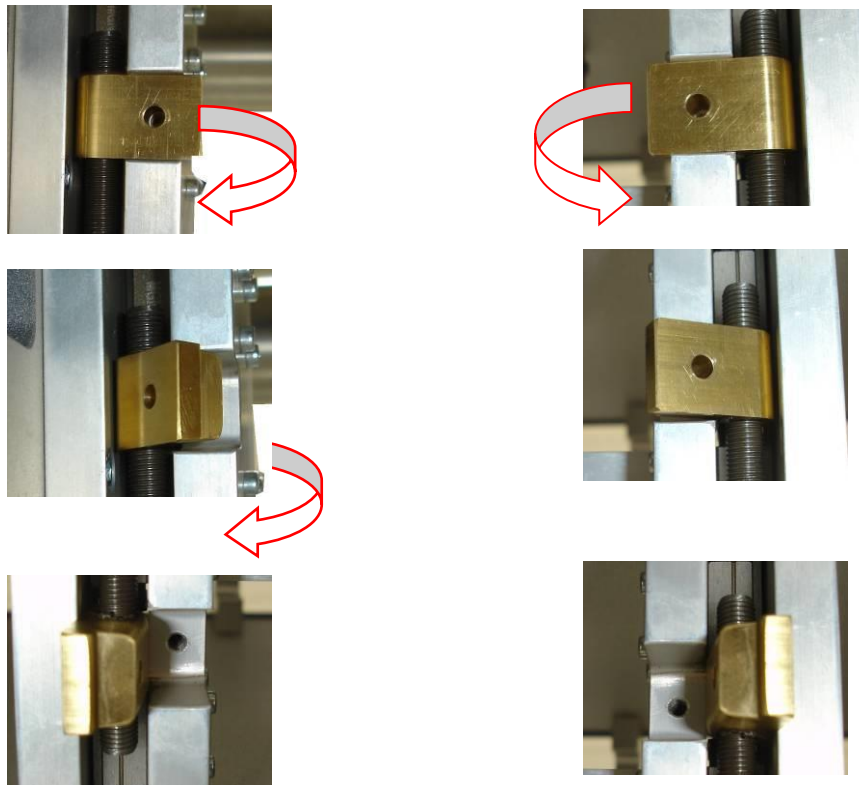

4. Accompany the spittoon assembly until it gets to the lowest position.

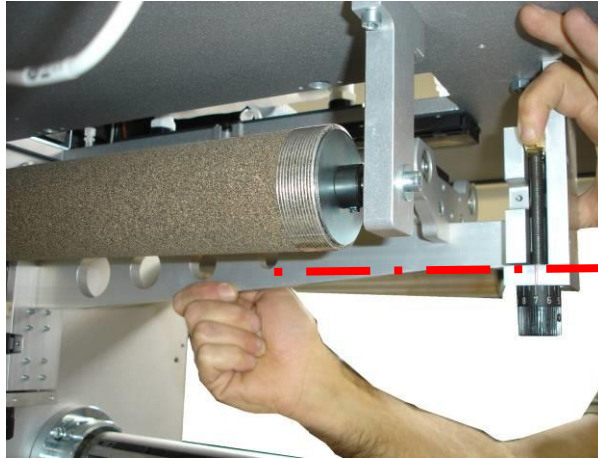

5. Having the spittoon in the lowest position gives clearance to safely and easily load new materials, or to do maintenance on the printer components in the printing zone.

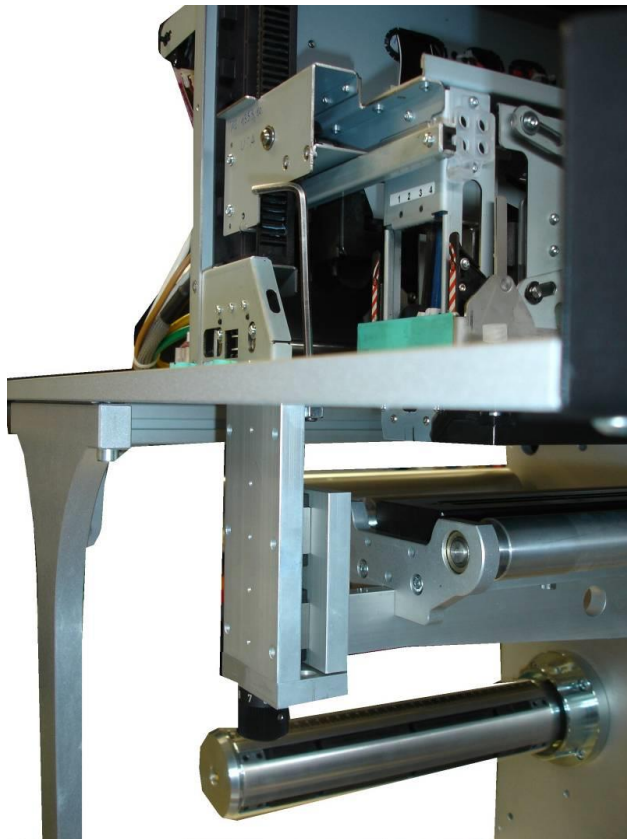

6. To put the spittoon assembly back to its original position without changing the preset PPS value, follow the instructions in reverse order.

## Inspection Tasks and Frequency

Perform the following inspection and replacement tasks at the time interval specified in the table below.

Note: All items in the table are dependent on system usage and application.

### Inspection and Replacement Tasks

Task	Check Daily	Check Weekly	Check Monthly	Check Every 750 hours	Check Every 5 Years	Replace As Needed
Area/Surface Cleaning	x					N/A
System Inspection:						
• Bulk Ink Supply Connection						
• Printhead (any ink drooling or leaking)	x					N/A
Fittings and Tubing						
Wiper Cartridge	x					x
AES Filter		x				
Fan Filter			x			x
Maintenance Module			x			x
Kinematic Mounts			x			x
Refill Pump				x		x
Circulation Pumps				x		x
Wiper Assembly					x	x
WIMM					x	x
Printhead Cradle Lift Mechanism						x

## Changing consumables

### Install the wiper cartridge

- Verify that the following conditions are met:
  - Printhead cradle is in the RAISE position
  - Wiper carrier is in the HOME position
  - The system is powered on.
- Hold the wiper cartridge in one hand and locate the blue tab protruding from the cartridge.

3. Gently, but firmly, pull down on the tab to remove it from the wiper cartridge.

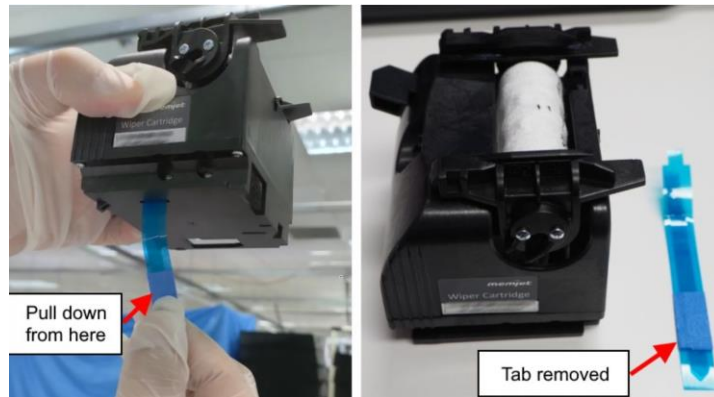

4. Move the Wiper Carrier to the SERVICE position. Insertion only happens at the SERVICE position.
5. Manually insert the wiper cartridge and reseal it properly until you hear a click sound.
6. Move the printhead to the CAP position. This will move the wiper to the HOME position.



### Installing the ink cartridges



**CAUTION:** Wear powder-free, nitrile gloves and protective glasses before starting this procedure.

The tubes and electrical cables are color coded; they have to be connected to the matching cartridge.

1. Connect the CPC connector (female) on the IDS Supply Line to the male connector on the bulk ink supply.
  - a. Press the unlock tab (see arrow in #1).
  - b. When the CPC connector (female) is unlocked (#2), insert the male connector.
  - c. The male connector presses the lock button (see arrow in #3) and moves it towards the lock position (#4).

Connectors should not come apart when pulled.

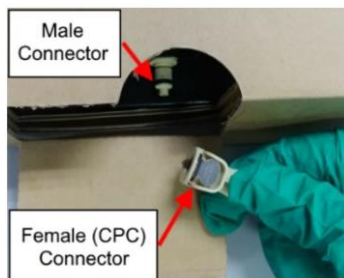
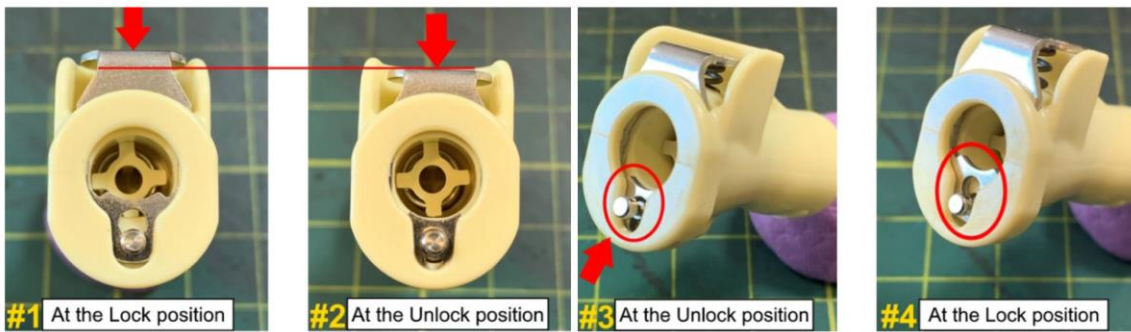

2. Connect the QAI cables (RJ12) to each ink cartridge.

### Installing the printhead

The following steps explain how to install a printhead and remove it.



**CAUTION:** To avoid contamination, wear new, powder-free, nitrile gloves before starting this procedure.

1. Verify that the Printhead Cradle is in the RAISE position before beginning this procedure.

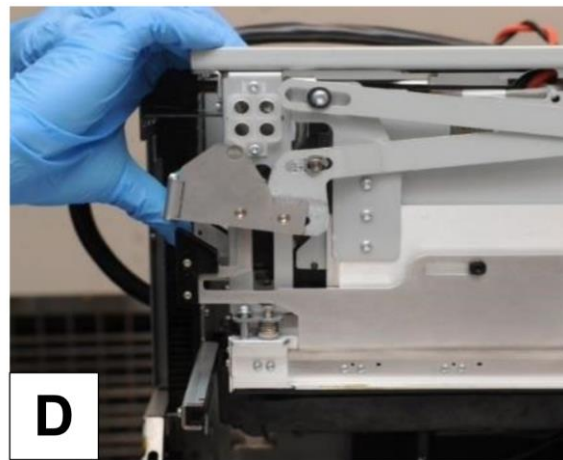
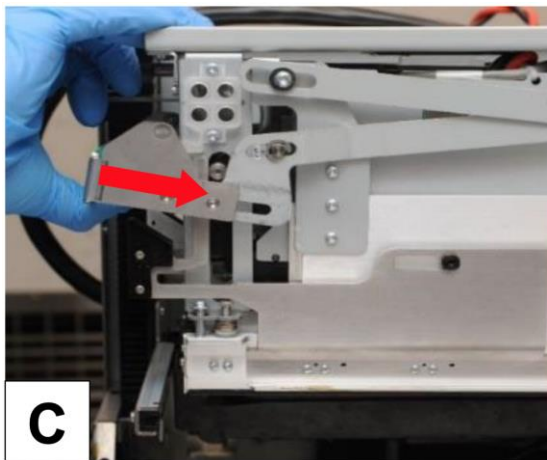

2. Unlock the printhead latch by pulling the green printhead latch out to the left side (A) and then raise it (B).
3. Slide it into the slot (C) and lock it into place (D).

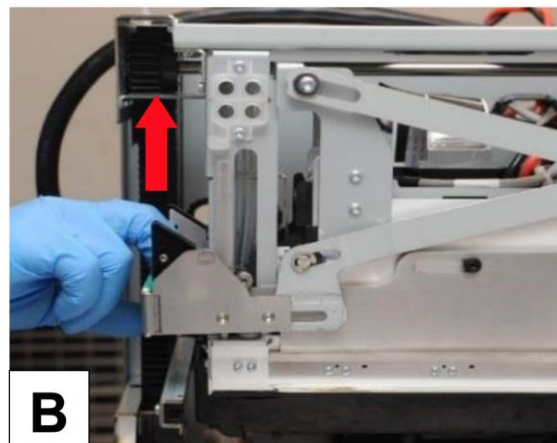
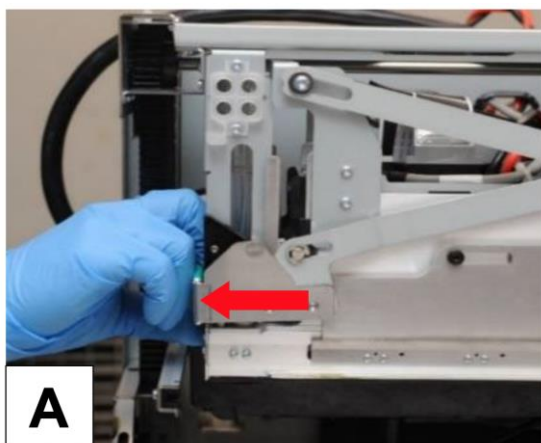

4. Ensure that the lever pin is locked into the barb holder slot.
5. Remove the printhead from the cardboard box and foil bag.



6. Open the red protective case and remove the two orange ink port covers.

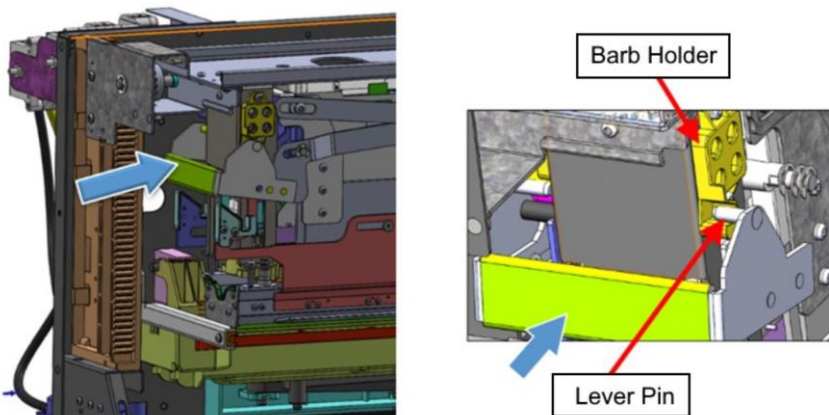
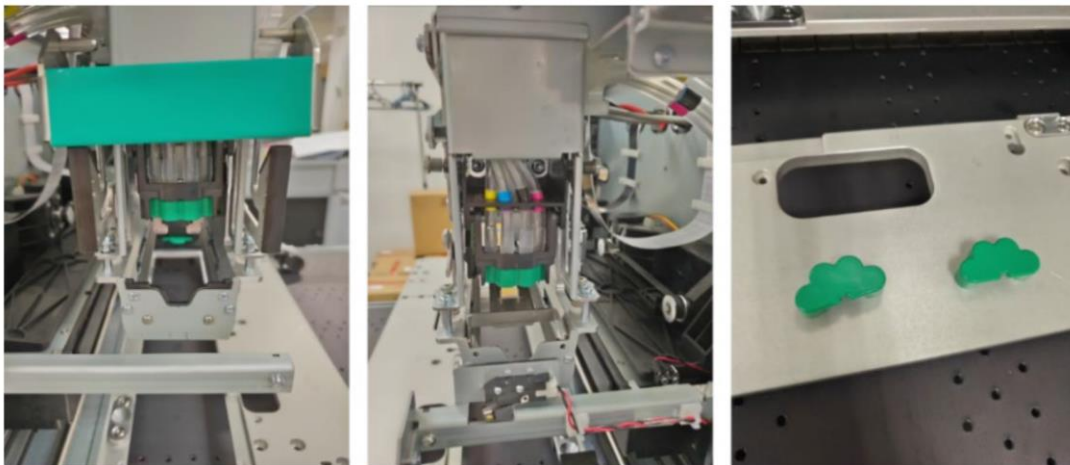

7. If the unit has been transported, on the Print Module, remove the two green covers from the fluidic couplings (one at each end).
8. Keep the red protective case and fluidic coupling covers for storage and shipping. Close the protective case during storage and put the green fluidic coupling covers in a clean plastic bag to prevent contamination.



**CAUTION:** Avoid contact with the printhead nozzle surface to prevent nozzle damage. Avoid contact with printhead ink ports and print unit couplings to prevent contamination. Do not touch the printhead electrical connectors (pads), nozzles, or contact pin area. Only handle the printhead via the black plastic areas.

9. With one hand, hold the side of the printhead with your index finger and thumb. With the other hand, hold the handle of the printhead and ensure that the red orientation key is oriented as shown in below.

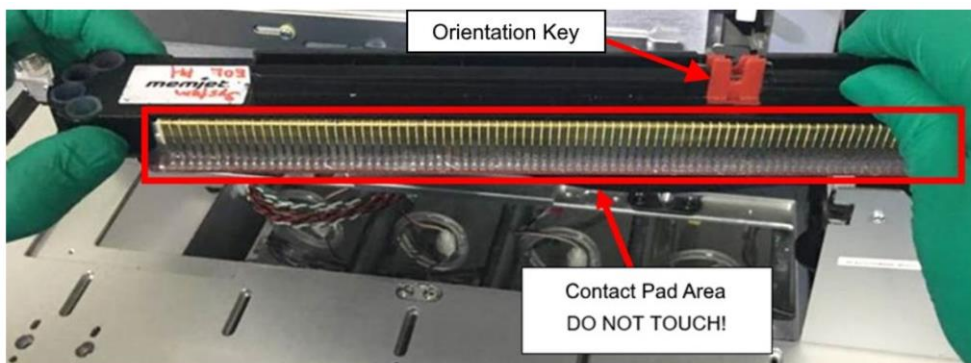

10. Align the red orientation key with the keyway inside the cradle and slide it along the plastic guide.

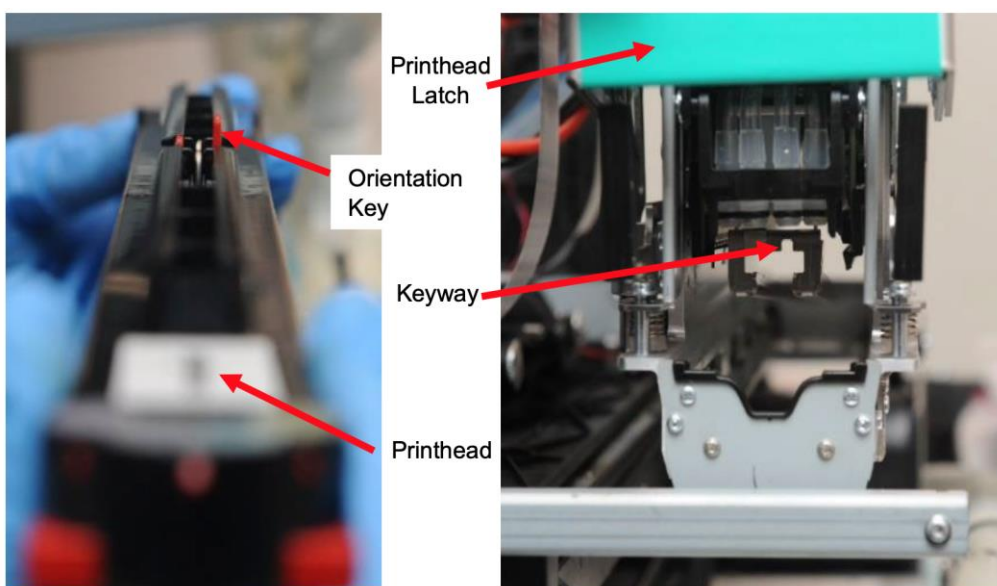



11. After you insert the printhead, push it with one finger to ensure that it is seated.

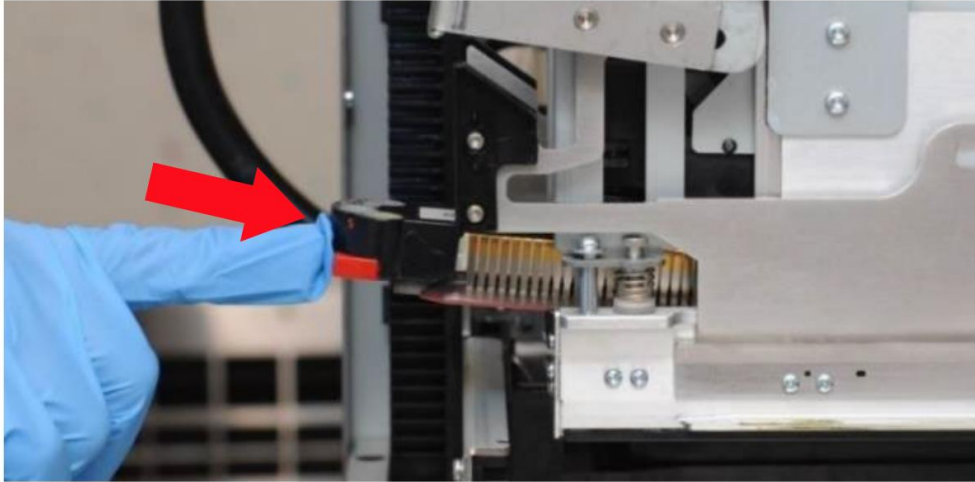

12. Disengage the printhead latch lever pin from the barb holder slot and pull it out to the side of the print module (E) shown below, then push the latch down (F).

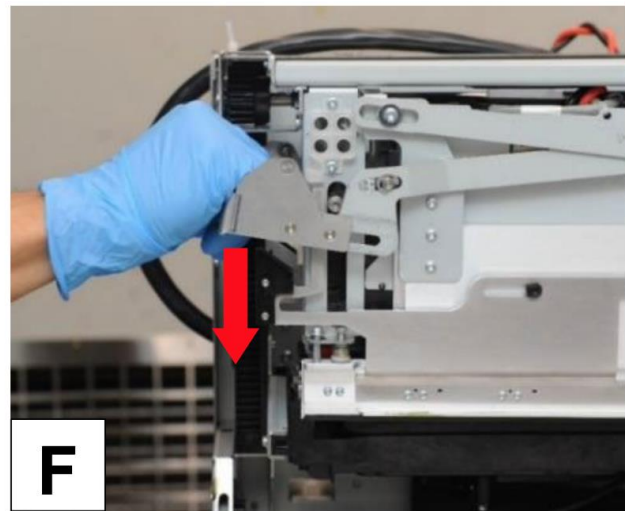
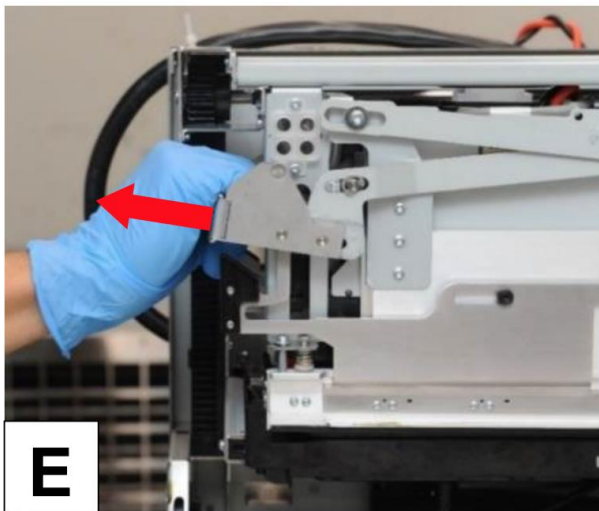

13. Below, visually inspect both ends of the installed printhead to ensure that the lower printhead surface (red part) is flush with the frame (aluminum part, silver in color). If it is not flush, remove the printhead and install again.

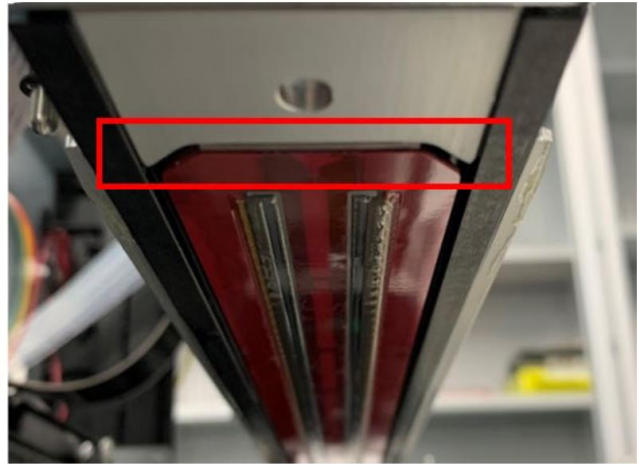
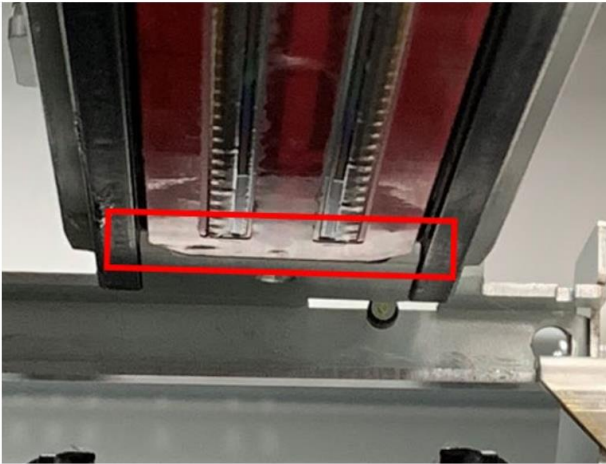

14. Slide the latch into the print module (G) until it is fully engaged (H).

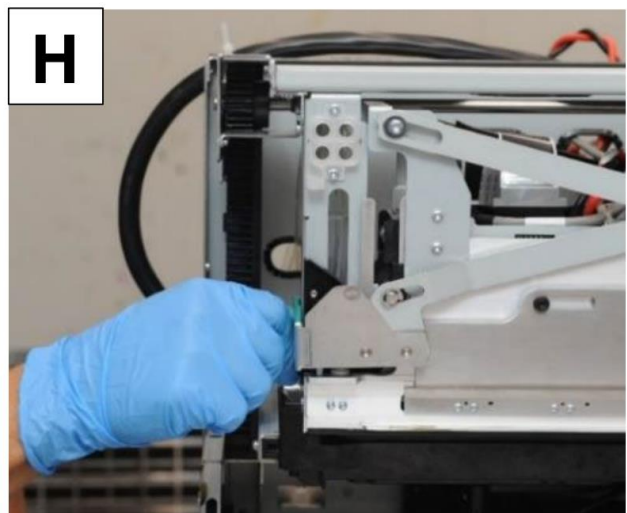
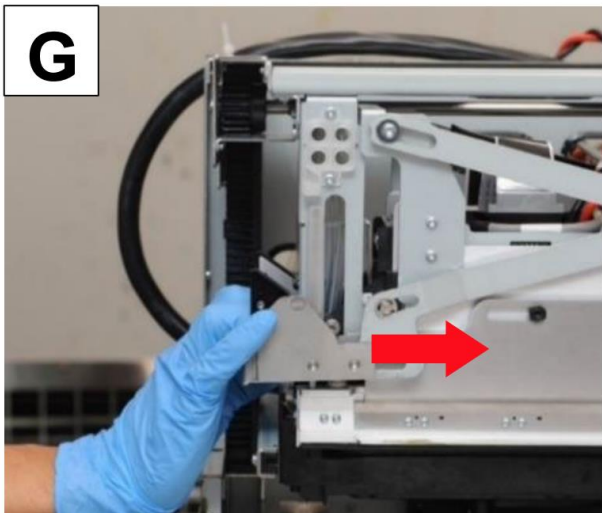

15. Verify that the printhead latch is fully engaged.



16. Verify that the three (3) labels on the Print Module are on the same plane.

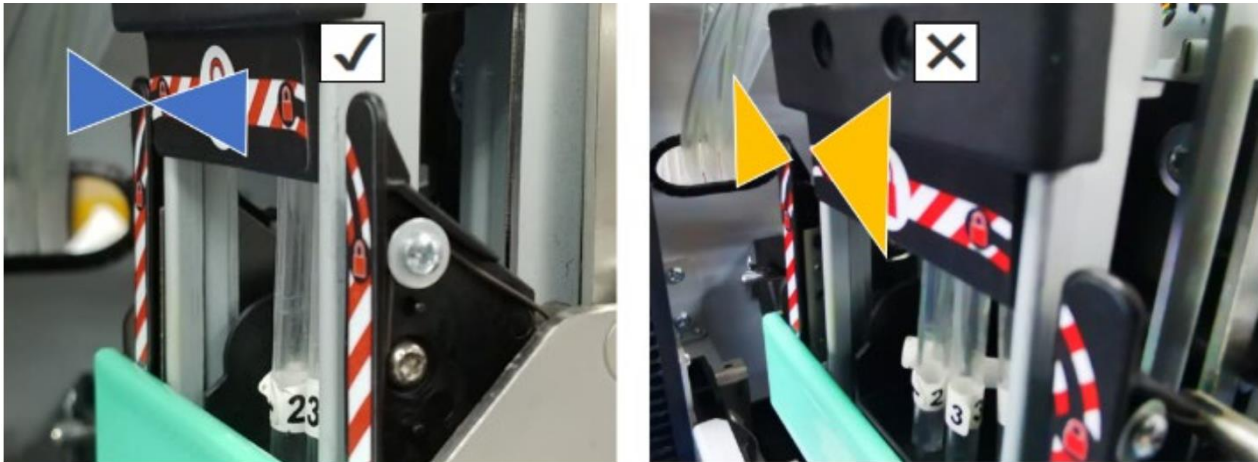

17. When the Printhead Cradle reaches the PRINT position, verify that it is fully seated into the datum surface by carefully pushing down on the green printhead latch:

- If there is no movement, that means the cradle is correctly seated.
- If there is movement, then the cradle is not fully seated. Contact Technical Support.

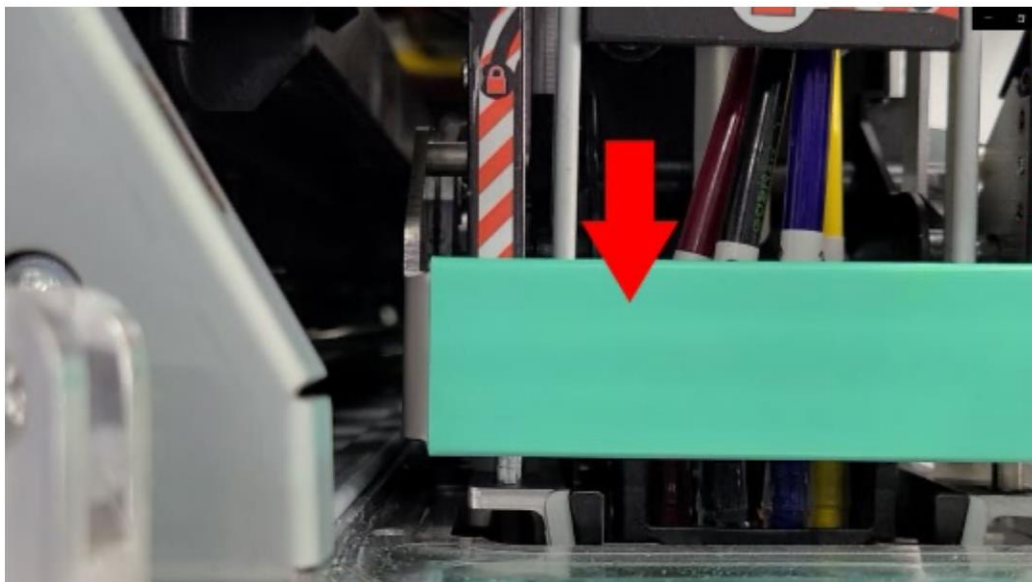

## PRINthead INSERTION TROUBLESHOOTING



Warning: Risk of damaging printer components.

### Printhead Insertion and Reinsertion

If a printhead insertion error occurs, try the following steps:

1. Locate the printhead handle and pull it in the direction shown below, taking care not to lift the handle.

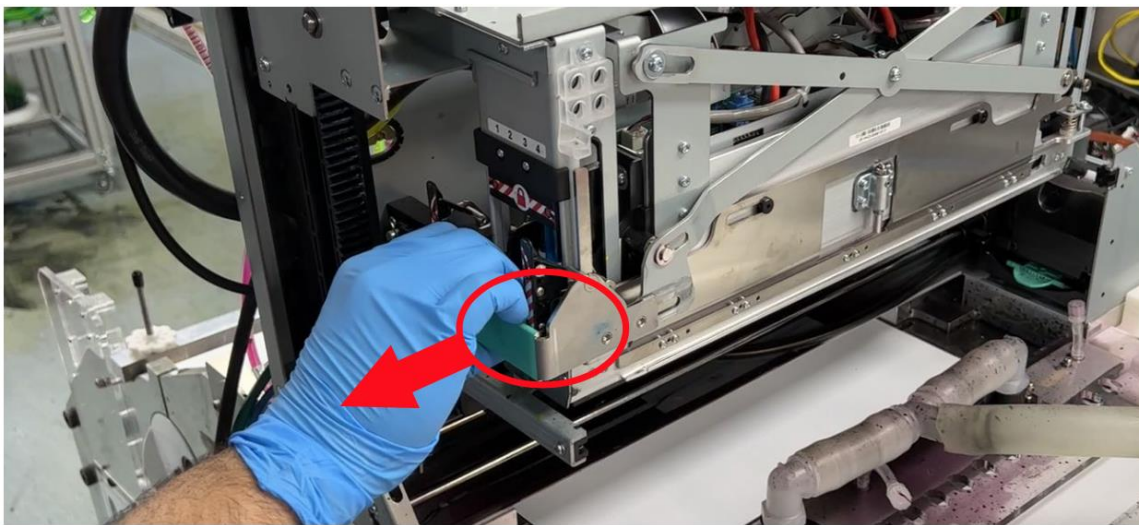

2. Push the printhead handle back into position so it locks



3. If the printhead insertion failure remains, then repeat from Step 1. If the printhead insertion continues to fail, refer to the next section.

### Checking Printhead FFC Connectivity

The above procedure should resolve most printhead insertion problems. If you have performed this procedure twice and you are still getting insertion errors, then refer to Technical Bulletin TB0009 FFC Retainer and follow these steps:

1. Unscrew and remove the cover.

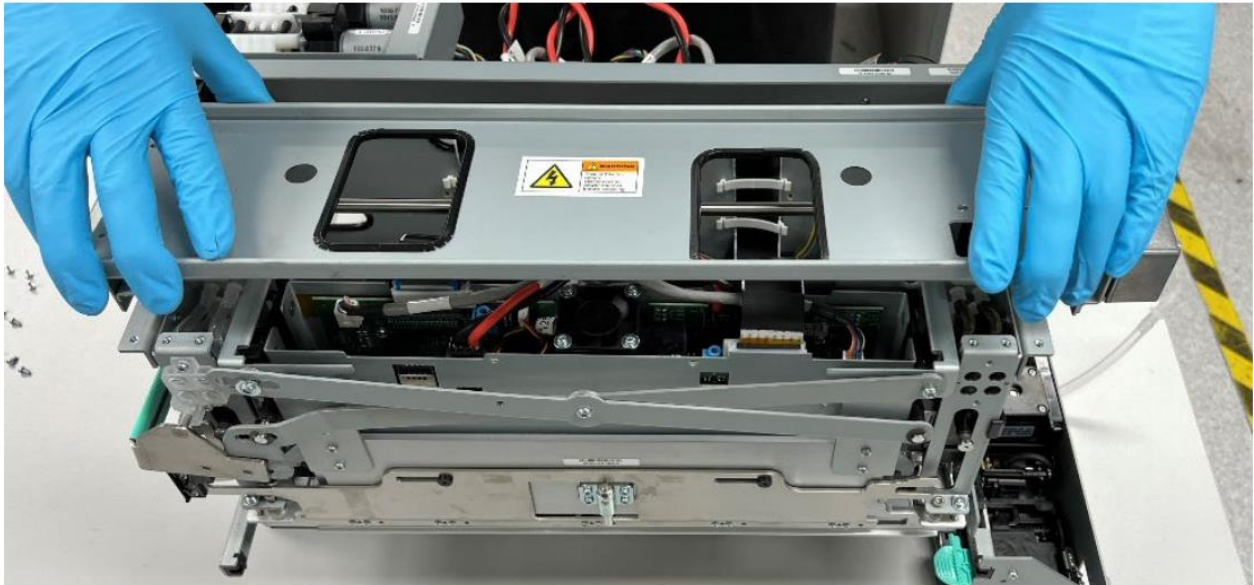

2. Unscrew and remove the FFC retainer clamp.

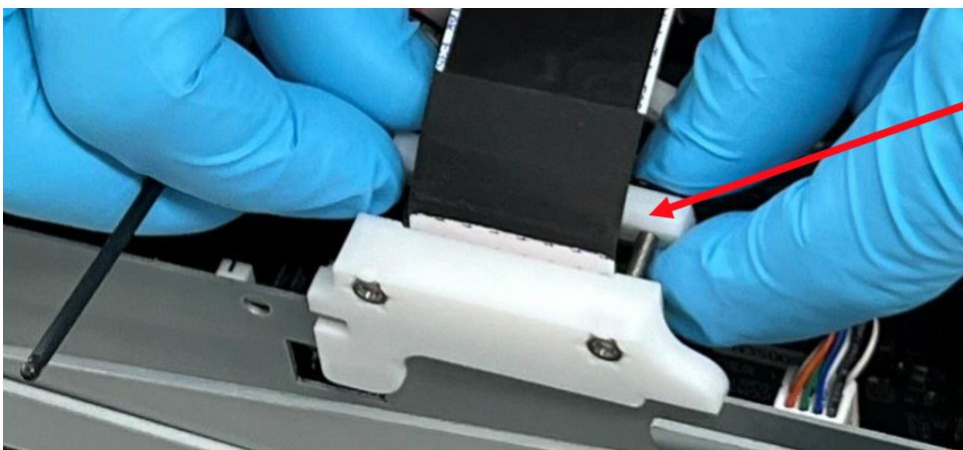

FFC Retainer  
Clamp

3. Undo the FFC clip.

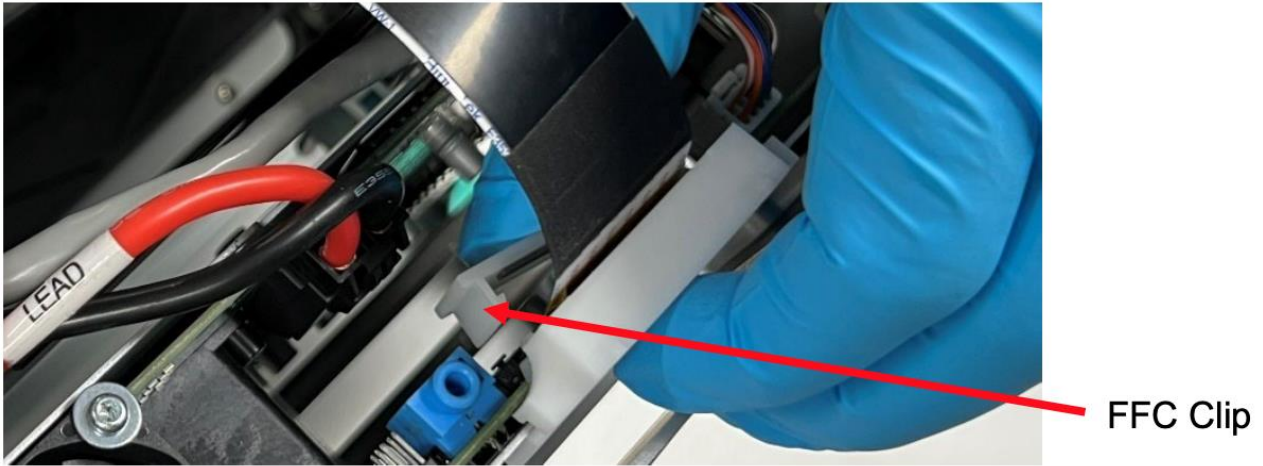

4. Remove the FFC cables, inspect the notches and the conductors. If there are no problems found, reinsert the FFC, reinstall the clip and the FFC retainer clamp and reassemble the print unit as per the technical bulletin.
5. If you are still getting printhead insertion errors, contact technical assistance.

## PRINthead MAINTENANCE

The table below shows a brief list of operations to preserve and maintain print component health.

Task	Description
Cap the Printhead	Printhead should be in capped position when not in use to prevent nozzles dehydrating.
Light service	Perform at the beginning and end of the shift to make sure nozzles are clean. If any printhead health issues, perform light service to restore nozzle health.
Medium service	Perform if light service is not successful in recovering the Printhead print quality. Medium service uses a higher suction vacuum than light service.
Heavy service	<ul style="list-style-type: none"> <li>• A heavy service consumes significant waste ink and time and is not needed during normal operations.</li> <li>• Only perform this rarely and only if successive light and medium services do not recover print quality.</li> </ul> <p>CAUTION: Never perform more than two heavy services back-to- back, or the WIMM tank may overflow.</p>
Replace wiper	Moves the wiper carriage to the loading/unloading position
Prime	<ul style="list-style-type: none"> <li>• Circulates ink from the ink reservoir to the printhead.</li> <li>• Initialize the printing system before priming to avoid the valve being left in an unknown position.</li> </ul>
Deprime	<ul style="list-style-type: none"> <li>• Drains ink from the printhead to the ink reservoir.</li> <li>• Initialize the printing system before depriming to avoid the valve being left in an unknown position.</li> </ul>

# FORK SENSOR

## Sensor adjustment

### SIMPLE AUTO-ADJUSTMENT

To be used in most applications.

Place the label support (or the background of the notch to be detected) between the fork prongs, using the marks available on the fork's edges for centering.

Press button "P1" for 1 second, then release it when LED "AUTO" starts blinking: that means the sensor is working in the auto-adjustment session.

After a while led "AUTO" stops blinking and turns off: that means the sensor has completed the auto-adjustment session.

Wait for 10 seconds: after that led "AUTO" turns on indicating that the sensor is ready for use.

### FINE AUTO-ADJUSTMENT

Recommended when there is not enough contrast between the object to be detected [label or notch] and its support [or background]).

Place the label support (or the background of the notch to be detected) between the fork prongs, using the marks available on the fork's edges for centering.

Press button "P1" for 1 second, then release it when LED "AUTO" starts blinking: that means the sensor is working in the auto-adjustment session.

After a while led "AUTO" stops blinking and turns off: that means the sensor has completed the auto-adjustment session on the background.

Perform steps 3 and 4 within 10 seconds. Place the label (or the notch to be detected) between the fork prongs, using the marks available on the fork's edges for centering.

Press button "P1": LED "AUTO" starts blinking again for a while; when it stops blinking, it means that the second and last auto-adjustment session is over too. The sensor is ready for use.

## Alarm signal

The fork sensor SF30PM-FM provides an alarm signal by blinking rapidly and continuously LED "AUTO". Alarm signal appears during the auto-adjustment session in two cases:

Either the background or the object to be detected are not detectable by the sensor because their transparency is out of the sensor reading range.

In the FINE AUTO-ADJUSTMENT mode, the difference in transparency between background and the object to be detected is lower than the lowest detectable by the sensor.



### LIGHT/DARK WORKING MODE

The fork sensor SF30PM-FM can work in light and dark mode. It is possible to select the working mode during the FINE AUTO- ADJUSTMENT as follows:

To select the light working mode: perform the first reading on background and the second one on the object to be detected.

To select the dark working mode: perform the first reading on the object to be detected and the second one on background.

N.B.: If you perform the SIMPLE AUTO-ADJUSTMENT the sensor will always work in the light mode.

### ALTERNATE READING MODE

It is possible to program the sensor so that it detects the presence of the object alternatively. This function is useful in case you want to detect the object (for example labels) which have an empty or more transparent area inside. This way the sensor will provide the output corresponding to "object present" even while detecting the empty or more transparent area inside the object.

To select sensor's working mode, alternate reading mode or continuous reading mode, follow these steps:  
Disconnect sensor's power supply.

While keeping button "P1" pressed, re-connect sensor's power supply.

Keep the button pressed for 4 seconds to enter into the reading mode modifying session: led "AUTO" starts blinking; the way it blinks indicates which reading mode is active at present: blink - pause - blink - pause ...: continuous reading mode (normal) double blink - pause - double blink - pause ...: alternate reading mode.

By pressing for a moment, the button "P1" (after having released it) the opposite reading mode will be selected. If for 10 seconds the button "P1" is not pressed, led "AUTO" will stop blinking, indicating that the sensor has quit the reading mode modifying session and is ready to work.

## Disclaimer

This document is provided to the recipient subject to and in accordance with the terms of

1. a non-disclosure agreement; and/or
2. a commercial agreement

Signed by recipient and the author and/or provider of this document.

This document contains draft and preliminary information that may vary and is provided for discussion purposes only. It is not to be used as a basis for commercial assessment.

To the extent permitted by law, and except as may be expressly agreed in writing by recipient and the author and/or provider, this document is provided "AS IS" without warranty of any kind, including but not limited to, implied warranties of accuracy, merchantability, fitness for a particular purpose and non-infringement of any third-party intellectual property rights.

The author and/or provider will not be liable for any misstatements or omissions, including in relation to instructions for the operation, use or maintenance of any equipment, samples, components or software. Recipient acknowledges and agrees that whilst care has been taken in compiling this information, it may contain estimates and draft information, and may not be current, accurate or complete.

Only representation made in executed agreements will be binding on recipient and the author and/or provider of this document.

Some of the materials used in this document are based on samples or scans created by other Afinia Label programs.

## **Contact Support**

USA:

PH: 952-556-1608

Email: [support@afinialabel.com](mailto:support@afinialabel.com)

Afinia Label  
8150 Mallory Court  
Chanhassen, MN 55317

United Kingdom:

PH: 44-845-250-7949

Email: [support@afinia.co.uk](mailto:support@afinia.co.uk)

Afinia Label  
7 Harriott Drive  
Heathcote Industrial Estate  
Warwick CV34 6TJ  
United Kingdom