Contents

SureColor T3475/T5475 User's Guide	9
Introduction to Your Printer	10
Printer Features	10
Optional Equipment and Replacement Parts.....	11
Notations Used in the Documentation	11
Printer Part Locations	11
Product Parts - Front	12
Product Parts - Top/Inside.....	13
Product Parts - Side.....	14
Using the Control Panel	14
Control Panel.....	15
Changing the LCD Screen Language.....	17
Selecting the Date and Time	18
Setting a Password and Locking the Control Panel	19
Using AirPrint	21
Wi-Fi or Wired Networking	22
Network Security Recommendations	22
Wi-Fi Infrastructure Mode Setup.....	23
Selecting Wireless Network Settings from the Control Panel	24
Wi-Fi Direct Mode Setup	26
Enabling Wi-Fi Direct Mode	26
Wi-Fi Protected Setup (WPS).....	28
Using WPS to Connect to a Network	28
Printing a Network Status Sheet.....	29
Printing a Network Connection Report	30
Network Connection Report Codes and Messages	32
Changing or Updating Network Connections	37
Accessing the Web Config Utility	37
Changing a USB Connection to a Wi-Fi Connection.....	38
Changing a Wi-Fi Connection to a Wired Network Connection.....	38

Connecting to a New Wi-Fi Router	39
Disabling Wi-Fi Features	40
Media Handling	41
Roll Paper Handling	41
Loading Roll Paper	41
Cutting Roll Paper	47
Cutting Roll Paper Manually.....	48
Removing Roll Paper.....	50
Loading Single Cut Sheets.....	52
Compatible Epson Papers.....	55
Paper or Media Type Settings - Printing Software.....	58
Selecting the Paper Settings for Each Source - Control Panel	59
Paper Type Settings - Control Panel	61
Creating Custom Paper Configurations.....	62
Selecting Custom Paper Configurations.....	62
Printing from a Computer	64
Printing with Windows	64
Selecting Basic Print Settings - Windows	65
Document Size Options - Windows.....	67
Paper Source Options - Windows	67
Print Mode Options - Windows.....	68
Color Mode Options - Windows	68
Level Options - Windows	69
Using Layout Manager - Windows	71
Selecting Print Layout Options - Windows.....	76
Page Layout Options - Windows.....	76
Selecting Advanced Settings - Windows	78
Roll Paper Options - Windows	79
Selecting Additional Settings - Windows	81
Printing Your Document or Photo - Windows.....	82
Checking Print Status - Windows.....	83
Saving, Sharing, and Customizing the Printer Settings	83
Saving and Sharing Print Settings - Windows	83

Editing Print Setting Displays - Windows	85
Selecting Default Print Settings - Windows.....	86
Changing the Language of the Printer Software Screens	87
Changing Automatic Update Options	88
Printing with the Built-in Epson Driver - Windows 10 S.....	89
Selecting Print Settings - Windows 10 S.....	90
Printing on a Mac	92
Selecting Basic Print Settings - Mac	93
Paper Size Options - Mac	97
Paper Source Options - Mac.....	97
Print Mode Options - Mac	97
Color Mode Options - Mac	98
Level Options - Mac	99
Selecting Print Layout Options - Mac.....	100
Selecting Advanced Settings - Mac	100
Managing Color - Mac	103
Color Matching Options - Mac.....	104
Sizing Printed Images - Mac.....	104
Selecting Printing Preferences - Mac	105
Printing Preferences - Mac.....	105
Printing Your Document - Mac.....	106
Checking Print Status - Mac.....	107
Printing CAD Drawings.....	108
Printing CAD Drawings from the Printer Driver	108
Printing CAD Drawings in HP-GL/2 or HP RTL Mode.....	110
Printing from a USB Memory Device	112
USB Memory Device Requirements.....	112
Connecting and Printing from a USB Memory Device	112
Memory Device Settings Menu.....	113
Using Your Printer as a Copier.....	116
Connecting a Scanner to Your Printer	116
Placing Originals in the Scanner	117
Printing Enlarged Copies from the Scanner	118

Supported Copy Sizes	119
Using the Control Panel Menus.....	121
Accessing the Printer's Menus	121
Paper Setting Menu.....	122
Basic Settings Menu.....	126
Printer Settings Menu.....	128
Network Settings Menu	135
System Administrator Settings Menu	135
Maintenance Menu.....	137
Printer Status/Print Menu	138
Replacing Ink Cartridges and Maintenance Boxes.....	139
Check Cartridge and Maintenance Box Status.....	139
Checking Ink Cartridge and Maintenance Box Status on the LCD Screen	139
Checking Ink Cartridge and Maintenance Box Status with Windows.....	140
Checking Cartridge and Maintenance Box Status - Mac	141
Purchase Epson Ink Cartridges and Maintenance Box	143
Ink Cartridge and Maintenance Box Part Numbers.....	143
Removing and Installing Ink Cartridges.....	143
Replacing the Maintenance Box.....	146
Adjusting Print Quality.....	151
Print Head Maintenance.....	151
Print Head Nozzle Check.....	151
Checking the Nozzles Using the Product Control Panel	151
Checking the Nozzles Using a Computer Utility	153
Print Head Cleaning	155
Cleaning the Print Head Using the Product Control Panel	156
Cleaning the Print Head Using a Computer Utility.....	157
Using the Powerful Cleaning Utility	159
Using Easy Adjustment	161
Adjusting Paper Feed Using the Product Control Panel	162
Adjusting Print Length Using the Product Control Panel	164
Aligning the Print Head Using the Product Control Panel	164
Cleaning the Roll Paper Feeder	165

Maintenance and Transportation	167
Replacing the Cutter.....	167
Replacing the Borderless Pads	170
Cleaning the Platen and Borderless Pad Edges.....	176
Moving or Transporting Your Product.....	179
Discharging Ink.....	181
Solving Problems	183
Checking for Software Updates.....	183
Product Status Messages	184
Resetting Control Panel Defaults	185
Solving Printer Problems.....	186
Printer Does Not Turn On	186
LCD Screen Shuts Off	186
Solving Network Problems	187
Product Cannot Connect to a Wireless Router or Access Point	187
Network Software Cannot Find Product on a Network.....	188
Product Does Not Appear in Mac Printer Window	189
Cannot Print Over a Network.....	190
Solving Printing Problems	191
Nothing Prints	192
Print Head Moves But Nothing Prints	192
Solving Paper Problems.....	193
Paper Feeding Problems.....	193
Paper Cutting/Ejection Problems.....	194
Paper is Creased.....	194
Roll Paper Jam Problems	195
Cut Sheet Paper Jam Problems	197
Solving Print Quality Problems	198
Overall Print Quality is Poor.....	199
Lines Are Misaligned	200
Prints are Scuffed or Smearred	200
Prints are Not Positioned Properly.....	201
Cannot Make Enlarged Copies from Scanner	202

Uninstall Your Product Software.....	202
Uninstalling Product Software - Windows.....	202
Uninstalling Product Software - Mac.....	203
Where to Get Help.....	204
Technical Specifications	206
Windows System Requirements	206
Mac System Requirements	207
Paper Specifications	207
Printable Area Specifications	208
Ink Cartridge Specifications.....	210
Dimension Specifications	211
Electrical Specifications	212
Environmental Specifications	213
Interface Specifications	213
Network Interface Specifications	213
Safety and Approvals Specifications	214
Notices	217
Important Safety Instructions.....	217
General Product Safety Instructions	217
Ink Cartridge Safety Instructions.....	219
LCD Screen Safety Instructions.....	220
Wireless Connection Safety Instructions	220
FCC Compliance Statement.....	221
Binding Arbitration and Class Waiver	221
Trademarks	225
Copyright Notice.....	225
A Note Concerning Responsible Use of Copyrighted Materials.....	226
Default Delay Times for Power Management for Epson Products	226
Copyright Attribution	226

SureColor T3475/T5475 User's Guide

Welcome to the SureColor T3475/T5475 *User's Guide*.

Note: Depending on your model, some LCD screens may look different and not all features may be available.

For a printable PDF copy of this guide, [click here](#).

Introduction to Your Printer

Refer to these sections to learn more about your printer and this manual.

[Printer Features](#)

[Notations Used in the Documentation](#)

[Printer Part Locations](#)

[Using the Control Panel](#)

[Using AirPrint](#)

Printer Features

The Epson SureColor T3475/T5475 printers include these special features:

High productivity

- Print accurate A1/D-size prints in 22 seconds (SureColor T5475) or 25 seconds (SureColor T3475)
- Available 110-, 350-, or 700-ml color ink cartridges with next generation UltraChrome XD2, 4-color, all-pigment ink
- HP-GL2 support for CAD software
- Wirelessly print from computers, tablets, or smartphones

Reliability

- Improved anti-dust design for reduced print head nozzle maintenance
- PrecisionCore Micro TFP print head offers Precision Droplet Control
- Nozzle Verification Technology detects nozzle condition and adjusts print quality

High resolution

- Prints at resolutions up to 2400 dpi

Easy-to-use setup and operation

- Intuitive, easy-to-read, 4.3-inch, color LCD touchscreen
- Print directly from USB flash drives (no PC required)
- Print directly from your smartphone or tablet using Wi-Fi Direct
- Included printer stand provides versatile placement options
- Easy-to-use software

- Supports roll paper or one cut sheet up to 24 inches (609.6 mm) [SureColor T3475] or 36 inches (914.4 mm) [SureColor T5475] wide

[Optional Equipment and Replacement Parts](#)

Parent topic: [Introduction to Your Printer](#)

Optional Equipment and Replacement Parts

You can purchase genuine Epson ink, paper, and accessories from an Epson authorized reseller. To find the nearest reseller, visit proimaging.epson.com (U.S.) or proimaging.epson.ca (Canada), select your product series and product, and click the **Where to Buy** button. Or call 800-GO-EPSON (800-463-7766) in the U.S. or 800-807-7766 in Canada.

Option or part	Part number
Roll media spindle (24") (SureColor T3475)	C12C933281
Roll media spindle (36") (SureColor T5475)	C12C933301
Maintenance box	T699700
Borderless replacement pad kit	C13S400064
Replacement printer cutter blade	S902007
1-year extended Epson Preferred Plus service plan	EPPT3454B1

Parent topic: [Printer Features](#)

Notations Used in the Documentation

Follow the guidelines in these notations as you read your documentation:

- **Warnings** must be followed carefully to avoid bodily injury.
- **Cautions** must be observed to avoid damage to your equipment.
- **Notes** contain important information about your printer.
- **Tips** contain additional printing information.

Parent topic: [Introduction to Your Printer](#)

Printer Part Locations

Check the printer part illustrations to learn about the parts on your printer.

Product Parts - Front

Product Parts - Top/Inside

Product Parts - Side

Parent topic: Introduction to Your Printer

Product Parts - Front

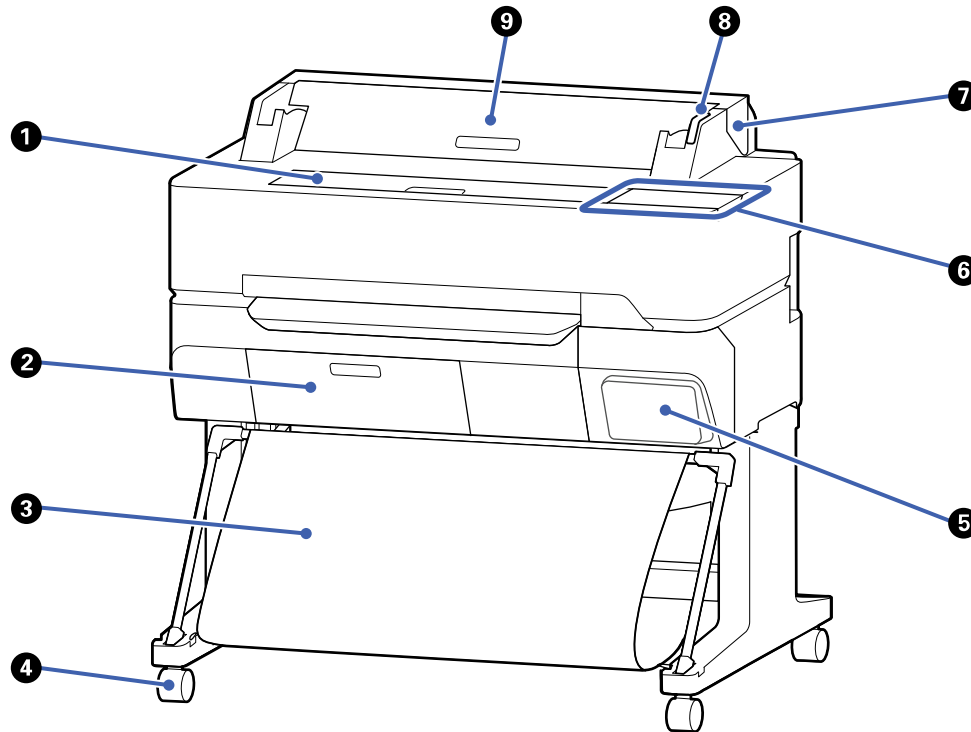

- 1 Front cover
- 2 Maintenance box cover
- 3 Paper basket
- 4 Casters (included with stand)
- 5 Cartridge cover

- 6 Control panel
- 7 Roll paper cover
- 8 Alert light
- 9 Cut sheet cover

Parent topic: [Printer Part Locations](#)

Product Parts - Top/Inside

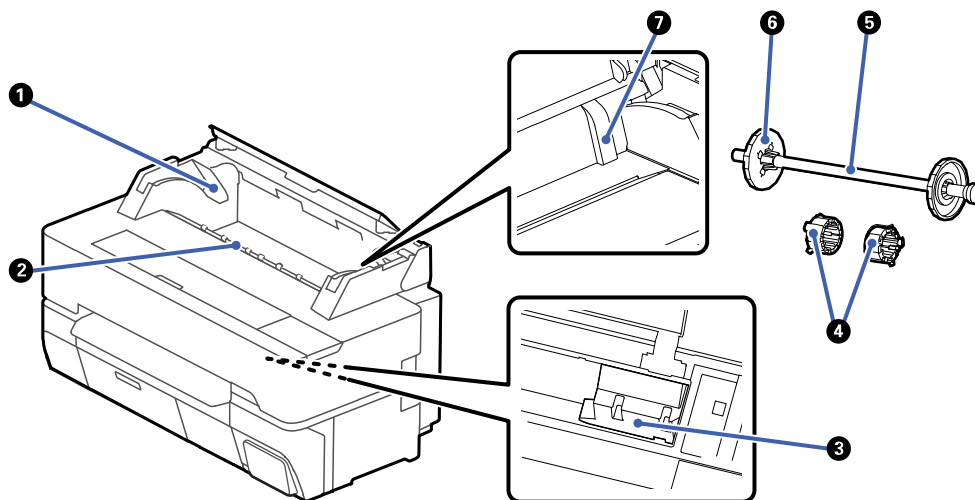

- 1 Spindle holder
- 2 Paper feeder
- 3 Print head
- 4 Roll core adapters (for 3-inch roll paper core)
- 5 Roll paper spindle
- 6 Translucent paper stop
- 7 Cut sheet paper guide

Parent topic: [Printer Part Locations](#)

Product Parts - Side

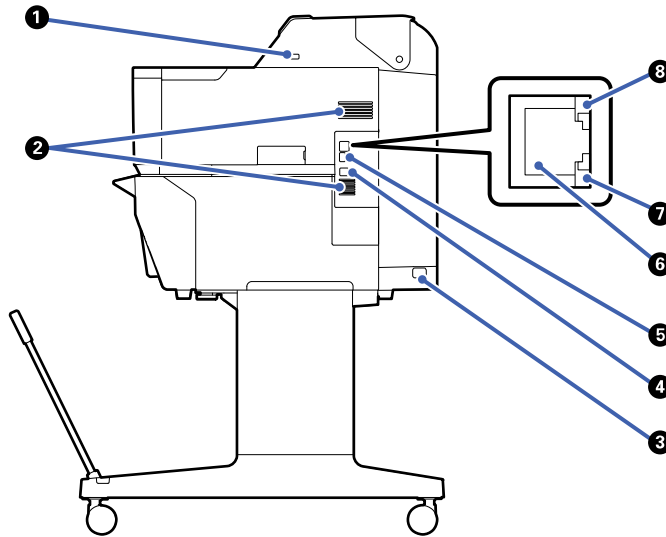

- 1 USB port (for flash drives)
- 2 Air vents
- 3 AC inlet
- 4 **USB** port (for computer connection)
- 5 **OPTION** port (for scanner connection)
- 6 Ethernet **LAN** port
- 7 Data light
- 8 Status light

Caution: Do not block the air vents shown above.

Parent topic: [Printer Part Locations](#)

Using the Control Panel

See these sections to learn about the control panel and select control panel settings.

- Control Panel
 - Changing the LCD Screen Language
 - Selecting the Date and Time
 - Setting a Password and Locking the Control Panel
- Parent topic:** Introduction to Your Printer

Control Panel

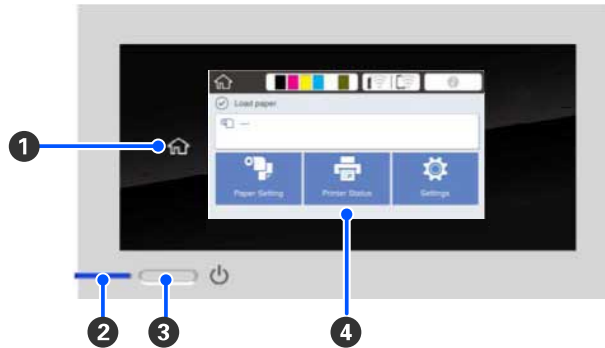

- 1 home button
- 2 power light
- 3 power button
- 4 LCD touchscreen

LCD Screen Display

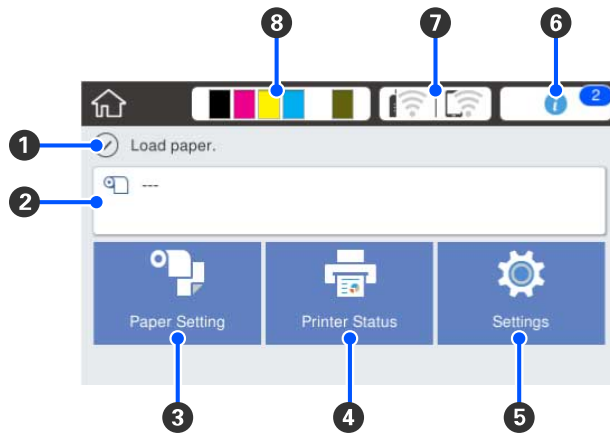



- 1 Status messages
- 2 Roll paper information
(When roll paper is not loaded, --- is displayed.)
- 3 **Paper Setting** menu
- 4 **Printer Status** menu (or **Enlarged Copy** if you connect a scanner)
- 5 **Settings** menu
- 6 Information display (displays notifications or warnings)

7 Network icons

 : No Ethernet connection

 : Ethernet connection established

 : No Wi-Fi connection

 : Wi-Fi network error or the product is searching for a connection

 : Wi-Fi connection established; the number of bars indicates signal strength

 : No Wi-Fi Direct connection

 : Wi-Fi Direct connection established

8 Consumables status icons (display remaining ink cartridge and maintenance box levels)

Parent topic: [Using the Control Panel](#)

Changing the LCD Screen Language

You can change the language used on the LCD screen.

1. Press the  home button, if necessary.
2. Select **Settings** > **Language**.

You see this screen:



3. Select a language.
4. Press the  home button to exit.

Parent topic: [Using the Control Panel](#)

Selecting the Date and Time

Before using your product, select the current date, time, and daylight saving phase in your area, and choose your preferred date and time format.

Note: This setting can be locked by an administrator. If you cannot access or change this setting, contact your administrator for assistance.

1. Press the  home button, if necessary.
2. Select **Settings** > **General Settings** > **Basic Settings** > **Date/Time Settings**.

You see this screen:

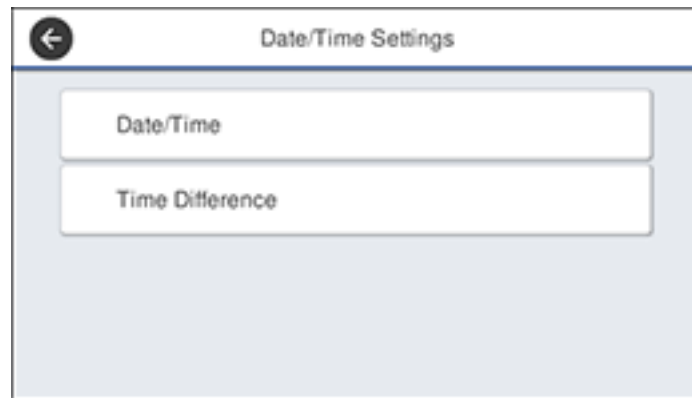

3. Select **Date/Time**.
4. Select the date format you want to use.
5. Use the on-screen keyboard to enter the current date and select **OK**.
6. Select the time format you want to use.
7. Use the on-screen keyboard to enter the current time and select **OK**.
8. Press the  home button to exit.

Parent topic: [Using the Control Panel](#)

Setting a Password and Locking the Control Panel

You can set an administrator password to lock the following settings and prevent them from being changed:

- Network settings
- Certain Printer Settings
- Certain Maintenance Settings
- System Administration settings
- Web Config settings
- EpsonNet Config settings

Note: The locked settings may be different depending on your specific model.

Note: This setting can be locked by an administrator. If you cannot access or change this setting, contact your administrator for assistance.

Note: For more information on administration settings, see the [Administrator's Guide](#).

1. Press the  home button, if necessary.
2. Select **Settings** > **General Settings** > **System Administration** > **Security Settings** > **Admin Settings**.

You see a screen like this:

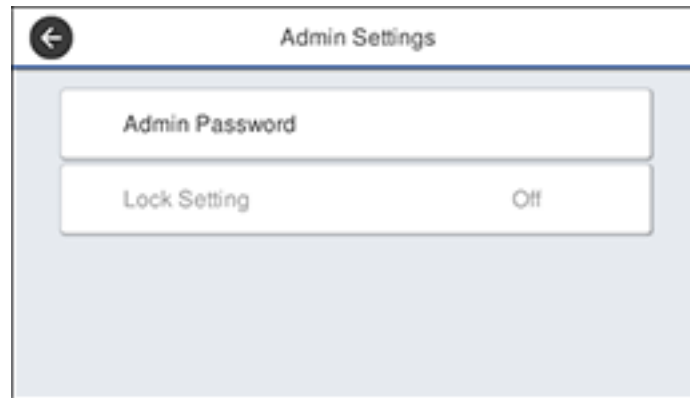

3. Select **Admin Password**.
4. Select **Register**.
5. Use the on-screen keyboard to enter a password and select **OK**.
6. Enter the password again to confirm and select **OK**.

Note: Keep a copy of your password in a safe place.

7. Select **OK**.
8. Select **Lock Setting > On** to lock the settings.

A prompt appears confirming that you want to enable locked settings. Select **Yes** to enable the setting and return to the home screen.

You must enter the admin password to access any of the locked settings.

Note: If you forget your password, contact Epson for assistance.

Parent topic: [Using the Control Panel](#)

Using AirPrint

AirPrint enables instant wireless printing from iPhone, iPad, iPod touch, and Mac without the need to install drivers or download software.



1. Load paper in your product.
2. Set up your product for wireless printing. See the link below.
3. Connect your Apple device to the same wireless network that your product is using.
4. Print from your device to your product.

Note: For details, see the AirPrint page on the Apple website.

Parent topic: [Introduction to Your Printer](#)

Related topics

[Wi-Fi or Wired Networking](#)

Wi-Fi or Wired Networking

See these sections to use your product on a Wi-Fi or wired network.

[Network Security Recommendations](#)

[Wi-Fi Infrastructure Mode Setup](#)

[Wi-Fi Direct Mode Setup](#)

[Wi-Fi Protected Setup \(WPS\)](#)

[Printing a Network Status Sheet](#)

[Printing a Network Connection Report](#)

[Changing or Updating Network Connections](#)

Network Security Recommendations

To help deter unauthorized access to your product over a network, you should protect your network environment using appropriate security measures.

Security measures such as these can help deter threats such as loss of user data, use of telephone and fax lines, and other intrusions:

- **Enable security on your wireless LAN**

Enable the appropriate security on the wireless LAN you plan to use with your product. Network security such as a network password can deter interception of traffic over the wireless LAN. Your router may already have a default password enabled by your Internet service provider (ISP). See your ISP and router documentation for instructions on how to change the default password and better secure your network.

- **Connect your product only to a network protected by a firewall**

Connecting your product directly to the Internet may leave it vulnerable to security threats. Instead, connect it to a router or other network connection protected by a firewall. Your router may already have a firewall set up by your Internet service provider; check with your ISP for confirmation. For best results, set up and use a private IP address for your network connection.

- **Change the default administrator password on your product**

If your product has an option to set an administrator password, change the default administrator password to deter access by unauthorized users to personal data stored on your product, such as IDs, passwords, and contact lists.

Parent topic: [Wi-Fi or Wired Networking](#)

Wi-Fi Infrastructure Mode Setup

You can set up your product to communicate with your computer using a wireless router or access point. The wireless router or access point can be connected to your computer over a wireless or wired network.

Note: You cannot connect to a wired and wireless network at the same time.

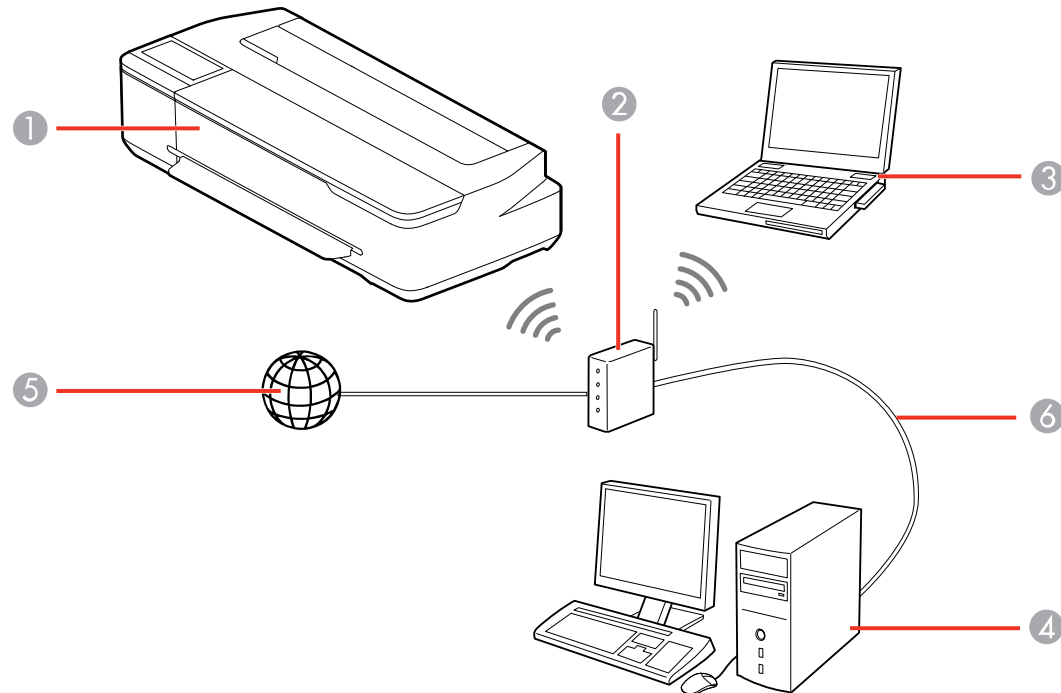

- 1 Epson product
- 2 Wireless router or access point
- 3 Computer with a wireless interface
- 4 Computer
- 5 Internet
- 6 Ethernet cable (used only for wired connection to the wireless router or access point)

Selecting Wireless Network Settings from the Control Panel



Parent topic: [Wi-Fi or Wired Networking](#)

Selecting Wireless Network Settings from the Control Panel

You can select or change wireless network settings using your product control panel.

To install your product on a wireless network, install the necessary software by downloading it from the Epson website. The installer program guides you through network setup.

Note: This setting can be locked by an administrator. If you cannot access or change this setting, contact your administrator for assistance.

1. Press the  home button, if necessary.
2. Select the   icon.

You see a screen like this:

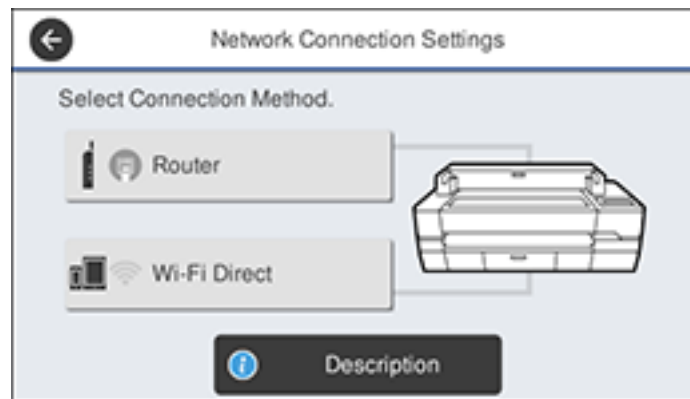



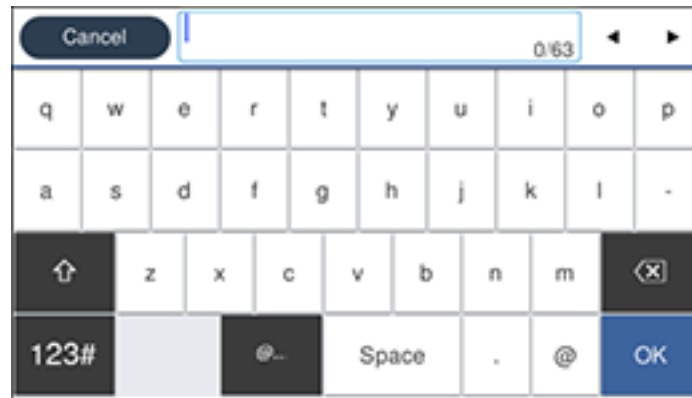

3. Select **Router** > **Start Setup** or **Change Settings**> **Wi-Fi Setup Wizard**.
4. Select the name of your wireless network or select **Enter Manually** to enter the name manually. Use the on-screen keyboard to enter your network name.

5. Select the **Enter Password** field and enter your wireless password using the on-screen keyboard.



Note: The network name and password are case sensitive. Be sure to correctly enter uppercase and lowercase letters, and numeric or special characters.

- To move the cursor, press the left or right arrows.
 - To enter numbers or symbols, select **123#**.
 - To change the case of letters, select .
 - To delete the previous character, select .
 - To enter a space, select **Space**.
6. Select **OK** when you finish entering your password.
 7. Confirm the displayed network settings and select **Start Setup** to save them.
 8. If you want to print a network setup report, select **Print Check Report**. (Otherwise, select **OK**.)
 9. Press the  home button to exit.

You see the  icon on the LCD screen and should be able to connect to your product directly from your computer or device, and then print. If you are printing from a computer, make sure you installed the network software from the Epson website.

Note: If you don't see the  icon, you may have selected the wrong network name or entered the password incorrectly. Repeat these steps to try again.

Parent topic: [Wi-Fi Infrastructure Mode Setup](#)

Wi-Fi Direct Mode Setup

You can set up your product to communicate directly with your computer or another device without requiring a wireless router or access point. In Wi-Fi Direct Mode, the product itself acts as a network access point for up to 8 devices.

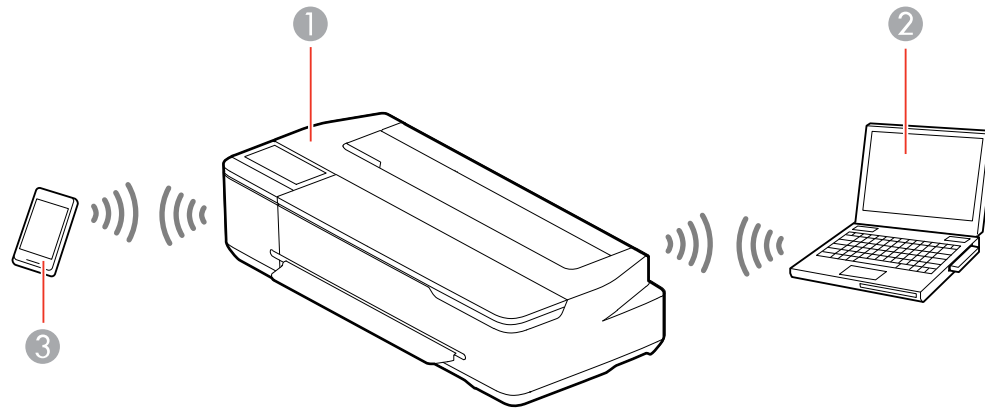

- 1 Epson product
- 2 Computer with a wireless interface
- 3 Other wireless device



[Enabling Wi-Fi Direct Mode](#)

Parent topic: [Wi-Fi or Wired Networking](#)

Enabling Wi-Fi Direct Mode

You can enable Wi-Fi Direct mode to allow direct communication between your product and computer or other devices without a wireless router or access point.

Note: This setting can be locked by an administrator. If you cannot access or change this setting, contact your administrator for assistance.

1. Press the  home button, if necessary.
2. Select the   icon.

You see a screen like this:

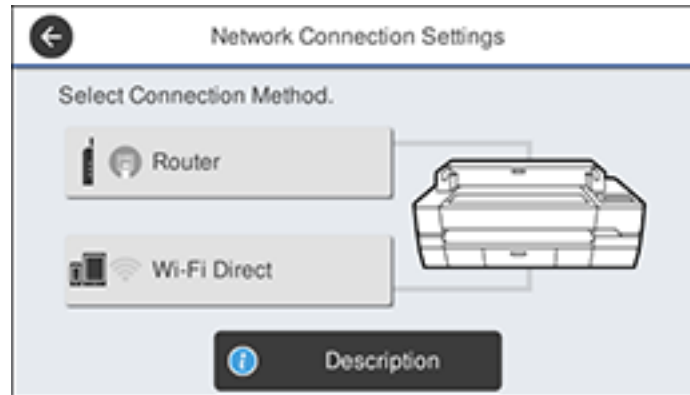



3. Select **Wi-Fi Direct > Start Setup > Start Setup**.

You see a screen like this:



4. Use your computer or wireless device to select the Wi-Fi network name (SSID) displayed on the LCD screen, then enter the password shown.
5. Press the  home button to exit.

You see the   icon on the LCD screen and should be able to connect to your product directly from your computer or device, and then print. If you are printing from a computer, make sure you installed the network software from the Epson website.

Note: If you don't see the  icon on the LCD screen, you may have selected the wrong network name or entered the password incorrectly. Repeat these steps to try again.

Parent topic: [Wi-Fi Direct Mode Setup](#)

Wi-Fi Protected Setup (WPS)

If your network uses a WPS-enabled wireless router or access point, you can quickly connect your product to the network using Wi-Fi Protected Setup (WPS).

Note: To check if your router is WPS-enabled, look for a button labeled **WPS** on your router or access point. If there is no hardware button, there may be a virtual WPS button in the software for the device. Check your network product documentation for details.



[Using WPS to Connect to a Network](#)

Parent topic: [Wi-Fi or Wired Networking](#)

Using WPS to Connect to a Network

If you have a WPS-enabled wireless router or access point, you can use Wi-Fi Protected Setup (WPS) to connect your product to the network.

Note: This setting can be locked by an administrator. If you cannot access or change this setting, contact your administrator for assistance.

1. Press the  home button, if necessary.
2. Select the   icon.

You see a screen like this:

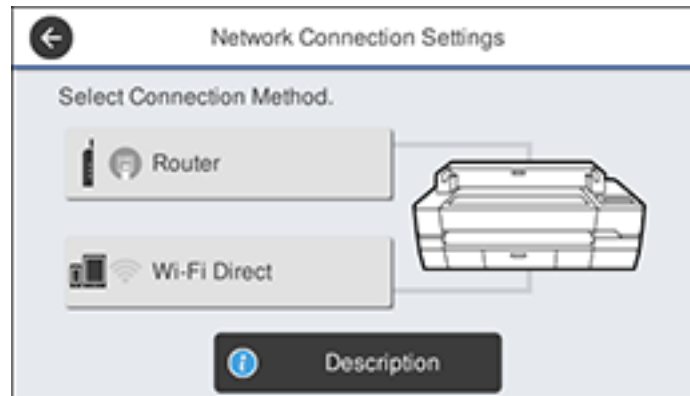

3. Select **Router** > **Start Setup** or **Change Settings**> **Push Button Setup (WPS)**.
4. Follow the instructions on the LCD screen to complete WPS setup.
5. Press the  home button to exit.

You see the  icon on the LCD screen and should be able to connect to your product directly from your computer or device, and then print. If you are printing from a computer, make sure you installed the network software from the Epson website.

Note: If you don't see the  icon, repeat these steps to try again.

Parent topic: [Wi-Fi Protected Setup \(WPS\)](#)

Printing a Network Status Sheet

You can print a network status sheet to help you determine the causes of any problems you may have using your product on a network.

Before you begin, make sure paper is loaded in the product.

1. Press the  home button, if necessary.
2. Select **Settings** > **General Settings** > **Network Settings** > **Network Status**.

You see a screen like this:

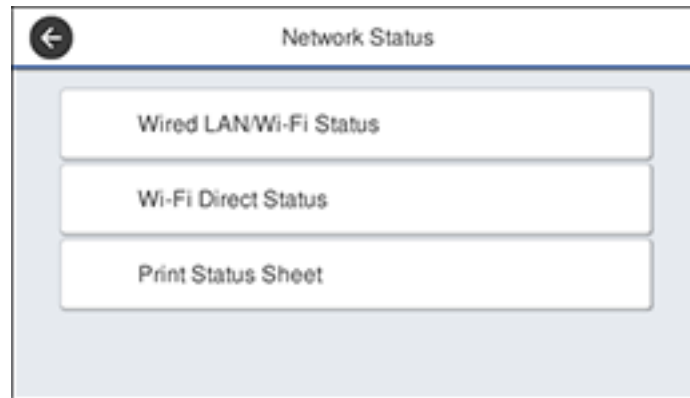

3. Select **Print Status Sheet > Print**.

Examine the settings shown on the network status sheet to diagnose any problems you have.

Parent topic: [Wi-Fi or Wired Networking](#)

Printing a Network Connection Report

You can print a network connection report to view solutions to any problems you may have using your product on a network.

1. Press the  home button, if necessary.
2. Select **Settings**.
3. Select **General Settings**.

You see a screen like this:



4. Select **Network Settings**.
5. Select **Connection Check**.
6. Select **Print Check Report**.
7. Select **Print**.

Examine the error codes and solutions shown on the network connection report.

[Network Connection Report Codes and Messages](#)

Parent topic: [Wi-Fi or Wired Networking](#)

Network Connection Report Codes and Messages

Check the error codes and messages on the network connection report to solve problems you may encounter with network connections. The tables here list solutions to problems based on the error codes and messages that may appear on the top of the report.

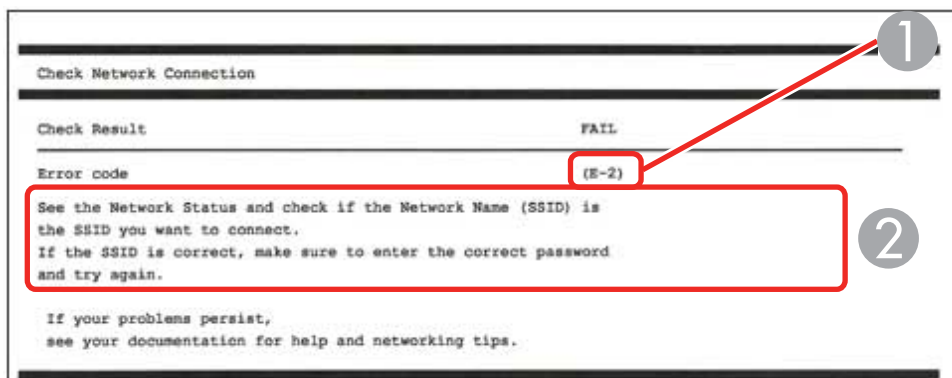

- 1 Error code
- 2 Message

Note: Error codes and messages listed here may not all apply to your product.

Error Codes and Messages

Error code and message	Solution
E-1 Confirm that the network cable is connected and network devices such as hub, router, or access point are turned on.	Make sure your router, access point, and/or hub are turned on, and the network cable is securely connected to your device and to your product. If you are trying to set up Wi-Fi, remove the network cable and set up Wi-Fi again. Ethernet and Wi-Fi cannot be connected at the same time.

Error code and message	Solution
<p>E-2, E-3, or E-7</p> <p>No wireless network names (SSID) found. Confirm that the router/access point is turned on and the wireless network (SSID) is set up correctly. Contact your network administrator for assistance.</p> <p>No wireless network names (SSID) found. Confirm that the wireless network name (SSID) of the PC you wish to connect is set up correctly. Contact your network administrator for assistance.</p> <p>Entered security key/password does not match the one set for your router/access point. Confirm security key/password. Contact your network administrator for assistance.</p>	<p>Check the following:</p> <ul style="list-style-type: none"> • Make sure your router or access point is turned on, and is correctly connected to your computer or network device. • Turn off the router or access point, wait about 10 seconds, and turn it on again. • Move your product closer to your router or access point, and remove any obstacles between them. Also move your product away from devices such as wireless phones or microwaves. • Confirm that the SSID shown on the network connection report matches the label on your router or access point. Also make sure your SSID uses only ASCII characters and symbols, or your product cannot display the SSID correctly. • If you are trying to connect using the WPS push button method, make sure your router or access point supports it. • If you are using a network password, check the label on your router or access point to confirm that you are using the correct password, or check with your network administrator or router/access point documentation. • If you are connecting to a smart device that generates an SSID, check the device documentation for the SSID and password you should use. • If your wireless connection suddenly disconnects, and another smart device was added to the network using a WPS push button method or your network was set up using a non-WPS push button method, try downloading and installing your product software again.

Error code and message	Solution
<p>E-5 Security mode (e.g. WEP, WPA) does not match the current setting of the printer. Confirm security mode. Contact your network administrator for assistance.</p>	<p>If the security on your router or access point is not one of the following types, change the type of security on your router or access point and reset your product's network settings.</p> <ul style="list-style-type: none"> • WEP-64 bit (40 bit) • WEP-128 bit (104 bit) • WPA PSK (TKIP/AES); also known as WPA Personal • WPA2 PSK (TKIP/AES); also known as WPA2 Personal • WPA (TKIP/AES) • WPA2 (TKIP/AES)
<p>E-6 MAC address of your printer may be filtered. Check whether your router/access point has restrictions such as MAC address filtering. See the documentation of the router/access point or contact your network administrator for assistance.</p>	<p>If your router or access point has MAC address filtering enabled, register your product's MAC address so it is not filtered. Locate the MAC address on the network connection report and check your router or access point documentation for instructions.</p> <p>If your router or access point is using shared authentication with WEP security, confirm that you are using the correct authentication key and index.</p> <p>If your router or access point limits the number of connected devices, raise the connection limit. See your router or access point documentation for instructions.</p>
<p>E-8 Incorrect IP address is assigned to the printer. Confirm IP address setup of the network device (hub, router, or access point). Contact your network administrator for assistance.</p>	<p>If your product's Obtain IP Address setting is set to Auto, enable DHCP on your router or access point. If it is set to Manual, the IP address may be out of range or on a different network segment; set a valid IP address using your product control panel or the Web Config utility.</p> <p>You can also try turning off your product and the router or access point, waiting about 10 seconds, and turning them on again.</p>

Error code and message	Solution
<p>E-9</p> <p>Confirm the connection and network setup of the PC or other device. Connection using the EpsonNet Setup is available. Contact your network administrator for assistance.</p>	<p>Make sure your computer or network device are turned on. Also make sure that you can access the Internet and other devices on the same network from the devices you are trying to connect to your product.</p> <p>If you still cannot connect to your product, turn off your router or access point, wait about 10 seconds, and turn it on again. Download and install your product software again to reset your network settings.</p>
<p>E-10</p> <p>Confirm IP address, subnet mask, and default gateway setup. Connection using the EpsonNet Setup is available. Contact your network administrator for assistance.</p>	<p>Make sure other devices on the network are turned on and do the following:</p> <ul style="list-style-type: none"> • If your product's Obtain IP Address setting is set to Manual, check the IP address, subnet mask, and default gateway addresses on the network connection report to see if they are correct. If not, correct the settings. • If DHCP is enabled, set your product's Obtain IP Address setting to Auto. If you want to use the DHCP-assigned address as a static address, set the Obtain IP Address setting to Manual, enter the product's IP address as listed on the network connection report, and set the subnet mask to 255.255.255.0. <p>If you still cannot connect to your product, turn off your router or access point, wait about 10 seconds, and turn it on again.</p>
<p>E-11</p> <p>Setup is incomplete. Confirm default gateway setup. Connection using the EpsonNet Setup is available. Contact your network administrator for assistance.</p>	<p>If you set your product's TCP/IP Setup setting to Manual, check that the default gateway address listed on the network connection report is correct. Also turn on the device that is set as the default gateway.</p>

Error code and message	Solution
<p>E-12</p> <p>Confirm the following:</p> <ul style="list-style-type: none"> -Entered security key/password is correct -Index of the security key/password is set to the first number -IP address, subnet mask, or default gateway setup is correct <p>Contact your network administrator for assistance.</p>	<p>Make sure other devices on the network are turned on and do the following:</p> <ul style="list-style-type: none"> • Make sure the IP address, subnet mask, and default gateway addresses are correct, if you are entering them manually. • Confirm that the subnet mask and default gateway addresses for other devices are the same. • Make sure the IP address does not conflict with other devices. <p>If you still cannot connect to your product, do the following:</p> <ul style="list-style-type: none"> • Turn off your router or access point, wait about 10 seconds, and turn it on again. • Download and install your product software again to reset your network settings. • If your router or access point uses WEP security with several registered passwords, make sure that the first registered password is set on your product.
<p>E-13</p> <p>Confirm the following:</p> <ul style="list-style-type: none"> -Entered security key/password is correct -Index of the security key/password is set to the first number -Connection and network setup of the PC or other device is correct <p>Contact your network administrator for assistance.</p>	<p>Make sure your router, access point, and/or hub are turned on. Also make sure the TCP/IP setup on your router, access point, and/or hub is not set manually; this may cause your product's network settings to differ from the manually set up devices.</p> <p>If you still cannot connect to your product, do the following:</p> <ul style="list-style-type: none"> • Turn off your router or access point, wait about 10 seconds, and turn it on again. • Download and install your product software again to reset your network settings. • If your router or access point uses WEP security with several registered passwords, make sure that the first registered password is set on your product.

Network Environment Messages

Message	Solution
The Wi-Fi environment needs to be improved. Turn the wireless router off and then turn it on. If the connection does not improve, see the documentation for the wireless router.	Move your product closer to your router or access point, and remove any obstacles between them. Then turn off your router or access point, wait about 10 seconds, and turn it back on again. If you still cannot connect to your product, check the documentation that came with your router or access point for solutions.
*No more devices can be connected. Disconnect one of the connected devices if you want to add another one.	You can connect up to 8 computers or other devices to your product using a Wi-Fi Direct (Simple AP) connection. If you want to add another device, disconnect an existing connected device first.

Parent topic: [Printing a Network Connection Report](#)

Changing or Updating Network Connections

See these sections to change or update how your product connects to a network.

[Accessing the Web Config Utility](#)

[Changing a USB Connection to a Wi-Fi Connection](#)

[Changing a Wi-Fi Connection to a Wired Network Connection](#)

[Connecting to a New Wi-Fi Router](#)

[Disabling Wi-Fi Features](#)

Parent topic: [Wi-Fi or Wired Networking](#)

Accessing the Web Config Utility

You can select your product's network settings and confirm its operating status using a web browser. You do this by accessing your product's built-in Web Config utility from a computer or other device that is connected to the same network as your product.

Note: For more information on the Web Config utility, see the [Administrator's Guide](#).

1. Print a network status sheet.
2. Locate the IP address for your product that is listed on the network status sheet.

3. On a computer or other device connected to the same network as your product, open a web browser.
4. Enter your product's IP address into the address bar.
You see the available Web Config utility options.

Parent topic: [Changing or Updating Network Connections](#)

Related tasks

[Printing a Network Status Sheet](#)

Changing a USB Connection to a Wi-Fi Connection

If you have already connected your product to your computer using a USB connection, you can change to a Wi-Fi connection.

1. Disconnect the USB cable from your product.
2. Uninstall your product software.
3. Download and install your product software from the Epson website using the instructions on the *Start Here* sheet.



Parent topic: [Changing or Updating Network Connections](#)

Related concepts

[Uninstall Your Product Software](#)

Changing a Wi-Fi Connection to a Wired Network Connection

If you have already connected your product to your computer wirelessly, you can change to a wired network connection if necessary.

1. Press the  home button, if necessary.
2. Select the   icon.

You see a screen like this:

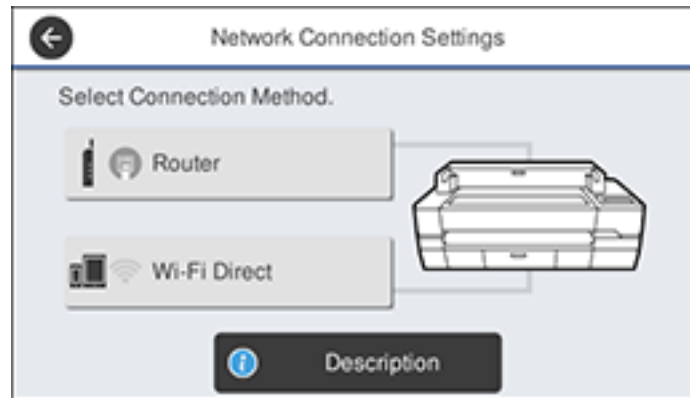

3. Select **Description** > **Wired LAN Connection Method** > **Start Setup**.
The Wi-Fi connection is disabled. Select **OK**.
4. Connect one end of an Ethernet network cable to the product's **LAN** port.
5. Connect the other end to any available LAN port on your router or access point.

Parent topic: [Changing or Updating Network Connections](#)

Connecting to a New Wi-Fi Router

If you change the wireless router you have been using on your network, you need to update your product's Wi-Fi connection to the new router.

Note: If you switch to a 5 GHz wireless router, set the router to operate in dual band (2.4 GHz and 5 GHz) mode. See your router documentation for instructions.

1. Do one of the following:
 - **Windows:** Uninstall your product software.
 - **Mac:** Go to the next step.
2. Download and install your product software from the Epson website using the instructions on the *Start Here* sheet.

Parent topic: [Changing or Updating Network Connections](#)

Related concepts



[Uninstall Your Product Software](#)

Disabling Wi-Fi Features

You may need to disable your product's Wi-Fi features if you change your network connection type or need to solve a problem with your network connection.

Note: Before disabling Wi-Fi features, make a note of your product's SSID (network name) and password.

Note: This setting can be locked by an administrator. If you cannot access or change this setting, contact your administrator for assistance.

1. Press the  home button, if necessary.
2. Select the   icon.

You see a screen like this:

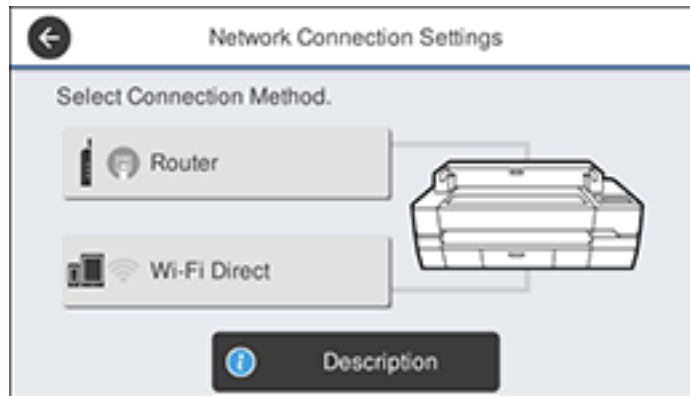

3. Select **Router** > **Start Setup** or **Change Settings** > **Others** > **Disable Wi-Fi**.
4. Select **Yes** to disable Wi-Fi.

Parent topic: [Changing or Updating Network Connections](#)

Media Handling

See these sections to load and handle media on your product.

[Roll Paper Handling](#)

[Loading Single Cut Sheets](#)

[Compatible Epson Papers](#)

[Paper or Media Type Settings - Printing Software](#)

[Selecting the Paper Settings for Each Source - Control Panel](#)

[Creating Custom Paper Configurations](#)

Roll Paper Handling

See these sections to load, cut, and remove roll paper in your product.

[Loading Roll Paper](#)

[Cutting Roll Paper](#)

[Removing Roll Paper](#)

Parent topic: [Media Handling](#)

Loading Roll Paper

Load roll paper onto the spindle before loading the roll onto the printer.

Note: To prevent dust from accumulating inside the printer, always keep the roll paper cover and cut sheet cover closed unless you are loading or unloading media.

1. Remove any tape and protective paper from the roll. Make sure the paper is cut straight across to avoid paper feeding problems.

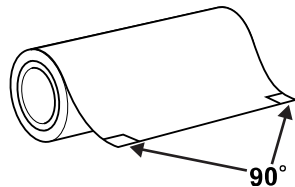

Note: Avoid touching the surface of your paper or leaving it on a dusty area.

2. Make sure **Load paper** is displayed on the home screen. If it is not shown, make sure to remove any roll paper or cut sheet paper from the printer.
3. Open the cut sheet and roll paper covers.

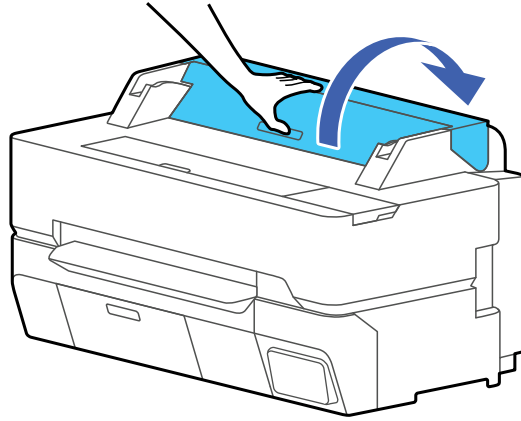

4. Remove the spindle.

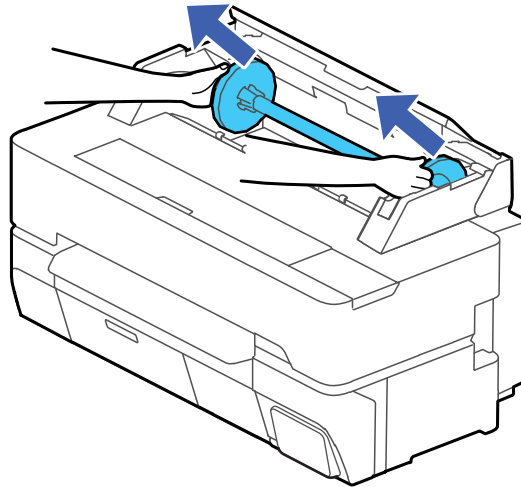

5. Remove the transparent paper stop from the spindle.

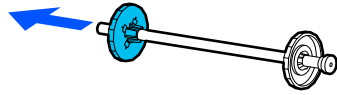

6. Do one of the following:

- **2-inch roll core:** If installed, remove the 3-inch core adapters from both paper stops. Push the two tabs on the paper stop to remove the adapter.

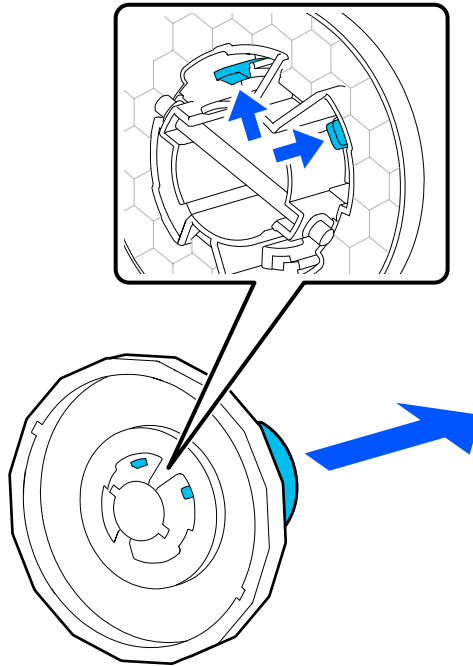

- **3-inch roll core:** Install the 3-inch core adapters on both paper stops. Align the triangle marks on the paper stop with the triangle marks on the adapter and push the adapter in until the tabs are secured.

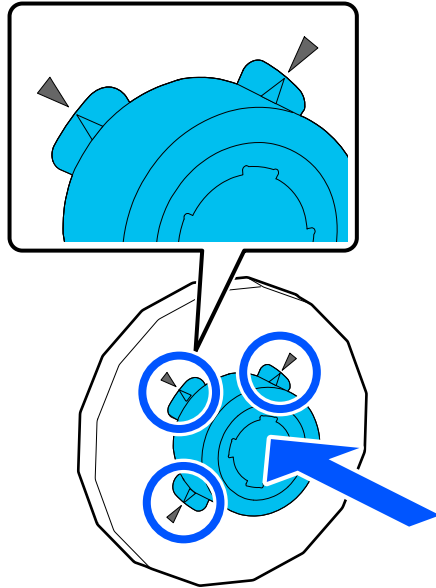

7. Insert the spindle into the roll paper core as shown, with the lead edge of the roll paper facing as shown.

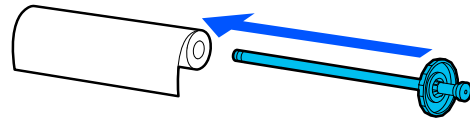

8. Push the fixed paper stop against the roll paper until there is no gap between the paper stop and the roll paper.

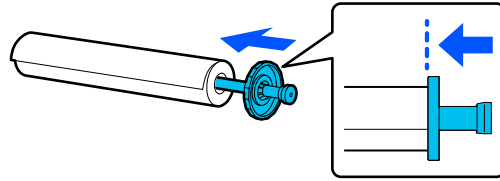

9. Attach the transparent paper stop to the spindle and press it in until there is no gap between the paper stop and the roll paper.

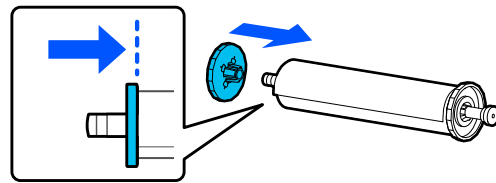

10. Place the roll paper into the spindle holders with the black end of the spindle on the right.

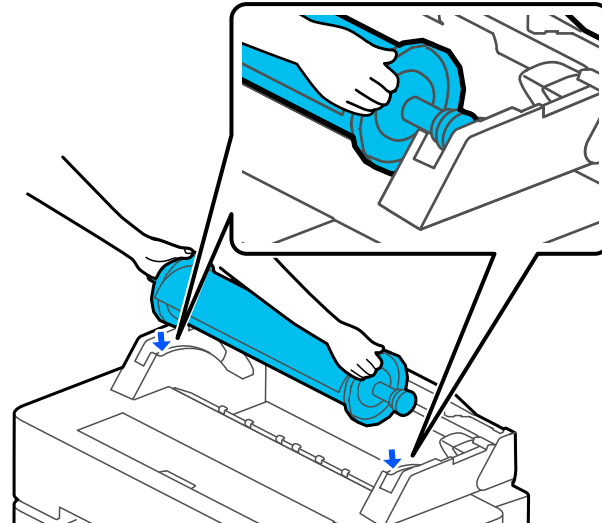

11. Slide the spindle along the spindle holders to fully load the roll.

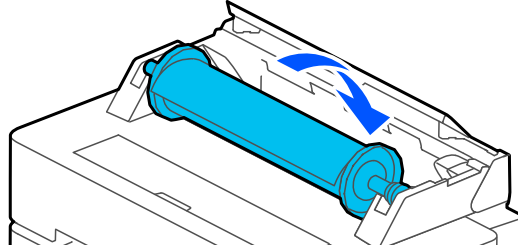

12. Insert the leading edge of the roll paper into the paper feeder until you hear a beep.

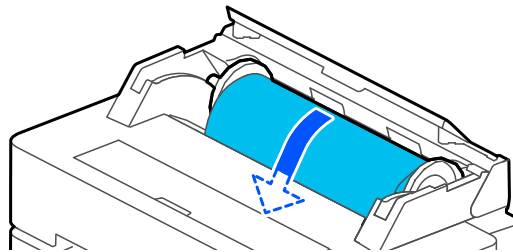
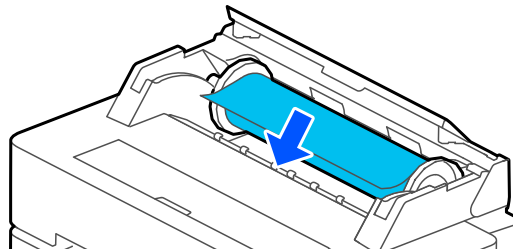

Note: Make sure the leading edge of the roll paper is not bent or skewed, or a paper jam or skew error may occur.

13. Close the roll paper cover and the cut sheet cover.

14. Select the paper type you loaded on the LCD screen and set the remaining amount, if necessary.

Note: If the roll paper has a barcode printed on it, the printer will read it and automatically load the correct settings. If you do not select settings within 90 seconds, the printer uses the displayed settings automatically.

15. Open the paper basket.

Note: If you are printing banners or other media larger than can fit in the paper basket, close the paper basket. Hold the ejected paper in both hands and support it so that the paper does not touch the floor.

Parent topic: [Roll Paper Handling](#)

Related references

[Paper Specifications](#)

[Compatible Epson Papers](#)

[Roll Paper Options - Windows](#)

Related tasks

[Removing Roll Paper](#)

[Selecting Advanced Settings - Mac](#)

Cutting Roll Paper

The printer has a built-in cutter that can automatically cut most paper types. When **Auto Cut** is turned on, paper is automatically cut after each page prints, or if the roll paper leading edge is not straight.

Caution: The built-in cutter is not recommended for use with commercially available canvas or synthetic paper, as it may dull the blade and require more frequent blade replacement. When you print on this paper type, turn off the **Auto Cut** setting and cut the print off the roll manually.

To switch between automatic or manual cutting methods, adjust the **Auto Cut** settings in the printer driver. The setting selected in the printer driver overrides the control panel setting.

[Cutting Roll Paper Manually](#)

Parent topic: [Roll Paper Handling](#)

Related references

[Roll Paper Options - Windows](#)

Related tasks

[Selecting Advanced Settings - Mac](#)

Cutting Roll Paper Manually

You can keep your prints on the roll until you manually cut them.

1. Turn off the **Auto Cut** setting in the printer driver or the control panel, depending on the situation:
 - If you want to cut the paper manually, turn off the setting in the printer driver. Select **Advanced > Roll Paper Option > Auto Cut**.

Note: The **Auto Cut** setting in the printer driver overrides the control panel setting. The printer driver setting returns to automatic cutting when you close the application.

- If you are using a paper type that cannot be cut with the built-in cutter, turn off the setting in the control panel. From the roll paper information area, select **Advanced Media Setting > Auto Cut > Off**.
 - If you want to turn off Auto Cut during enlarged copying, HP-GL/2 mode printing, or printing directly from the flash drive, turn off the setting in the control panel. From the roll paper information area, select **Advanced Media Setting > Auto Cut > Off**. The setting option will be saved for the currently selected paper type.
2. Print your document and wait for printing to finish.
 3. From the roll paper information area, select **Feed/Cut Paper**.

4. To move the paper into cutting position, press and hold **Forward** or **Backward** until the position you want to cut appears at the dotted line as shown.

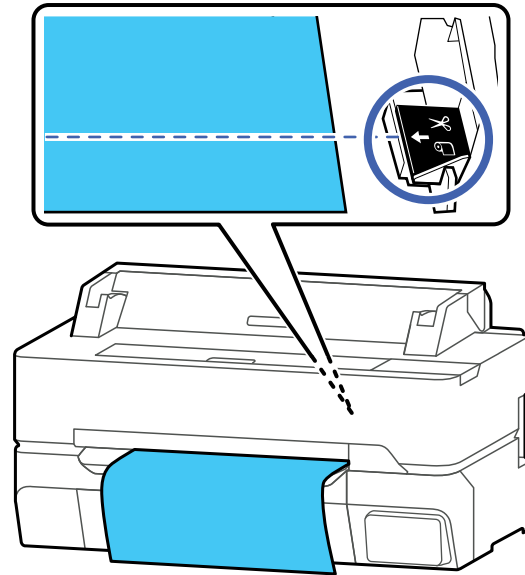

Note: You cannot set a cut position further inside than the bottom margin. When the length of paper beyond the cutting position is shorter than the minimum length, the paper will be fed automatically until the minimum length is reached.

- Plain paper or tracing paper: 3.9 inches (100 mm)
 - Photo paper or coated paper: 3.1 inches (80 mm)
 - Synthetic or other thick paper: 2.4 inches (60 mm)
5. To cut the paper, select **Cut**.
- If the **Auto Cut** setting is turned off only in the printer driver, the paper is cut and the paper leading edge returns to the print wait position.
 - If the **Auto Cut** setting is turned off in the control panel, select **Cut** to manually cut the paper using the built-in cutter or select **Print Cutting Guideline** to print a line on the paper to guide with manual cutting. Select **Done** when you are finished to rewind the paper.

Parent topic: [Cutting Roll Paper](#)

Removing Roll Paper

When you finish printing on roll paper, you should remove it from the printer to avoid indenting or creasing the lead edge of the paper.

1. Select **Remove** on the LCD screen. The roll paper rewinds automatically.

Note: Make sure the roll paper is rewound completely before removing it from the printer.

2. Open the cut sheet cover and roll paper cover.

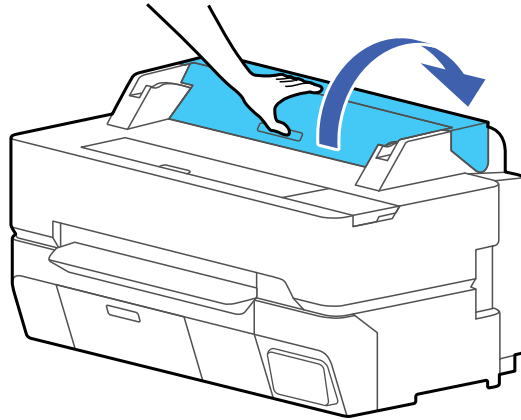

3. Hold both ends of the spindle and lift it up from the spindle holders.

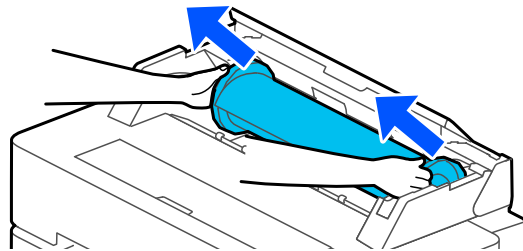

4. Remove the transparent paper stop from the spindle.

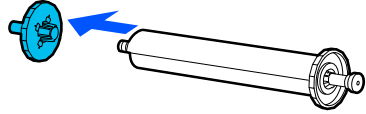

5. Remove the spindle from the roll paper.

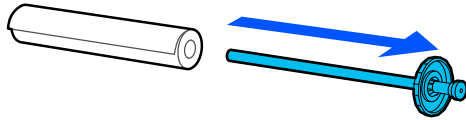

6. Place the roll paper in its original package.

Note: Store roll paper on its end or horizontally (if the packaging end-caps are installed). Never store roll paper on its side, as a flat spot can develop and lead to imaging artifacts on the prints. Do not store roll paper in dusty areas. Print head maintenance and cleanings increase if dust accumulates on the paper.

7. Attach the transparent paper stop to the empty spindle.

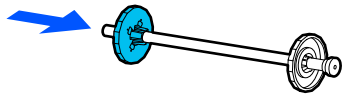

8. Place the spindle back into the printer.

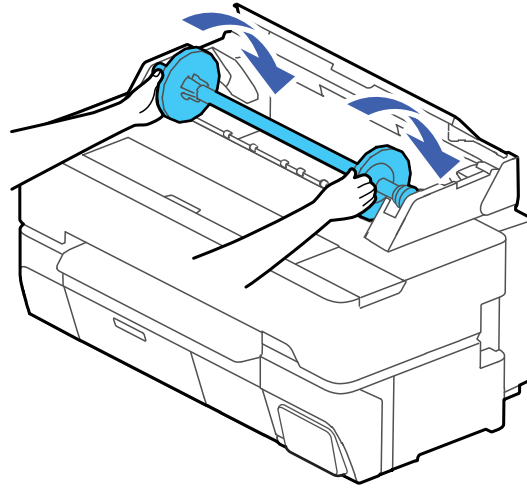

9. Close the roll paper cover and the cut sheet cover.

Note: To prevent dust from accumulating inside the printer, always keep the roll paper cover and cut sheet cover closed unless you are loading or unloading media.

Parent topic: [Roll Paper Handling](#)

Loading Single Cut Sheets

You can print on a variety of cut sheet paper types and sizes up to 24 inches (61 cm) [SureColor T3475] or 36 inches (91 cm) [SureColor T5475] wide and 0.1 inch (0.3 mm) thick. You can load and print on one sheet at a time.

Before printing on cut sheets, remove any loaded roll paper.

1. Make sure **Load paper** is displayed on the home screen. If it is not shown, make sure to remove any roll paper or cut sheet paper from the printer.
2. Select **Paper Setting > Cut Sheet (1 sheet)** on the LCD screen.

3. Open the cut sheet cover.

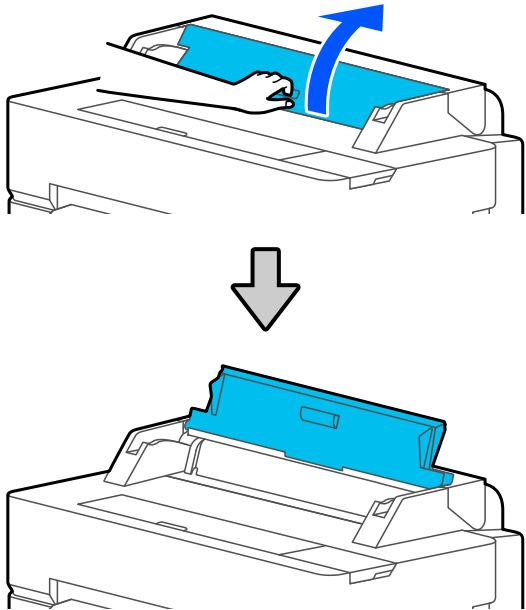

4. Load one sheet of paper, printable side up in portrait orientation. Align the right edge of the paper with the right hand guide on the printer and insert the paper into the printer.

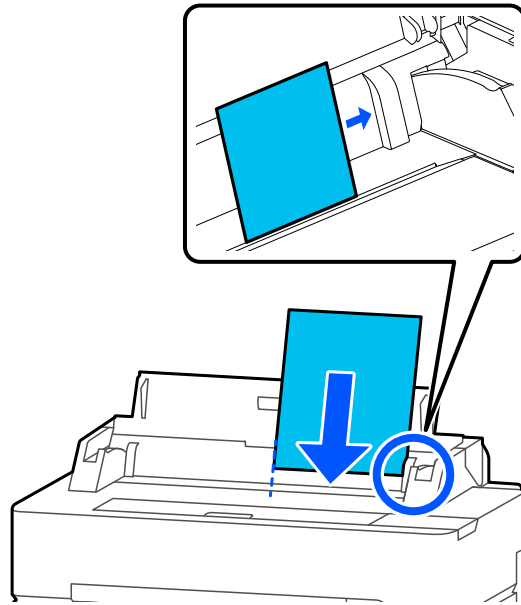

5. Insert the paper into the paper feeder until you hear a beep.

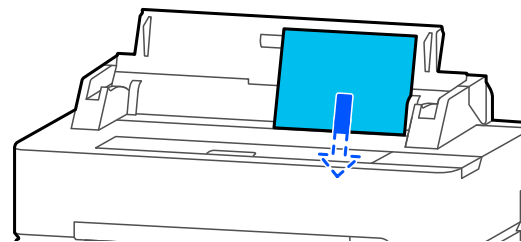

6. Make sure the leading edge of the paper is straight to prevent a skew error or paper jam. If it is straight, select **OK**, otherwise, select **Cancel** and reload the paper.
7. Select the paper type and size you loaded on the LCD screen.

To eject a loaded cut sheet without printing, select **Paper Setting > Cut Sheet (1 sheet) > Remove**. Select **OK** and pull the paper out of the printer as shown.

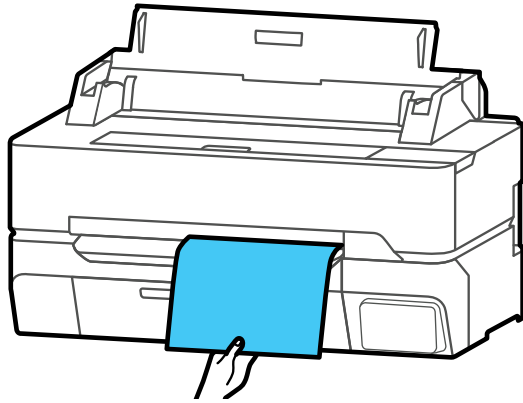

Parent topic: [Media Handling](#)

Related references

[Compatible Epson Papers](#)

[Paper Specifications](#)

Compatible Epson Papers

You can purchase genuine Epson ink, paper, and accessories from an Epson authorized reseller. To find the nearest reseller, visit proimaging.epson.com (U.S.) or proimaging.epson.ca (Canada), select your product series and product, and click the **Where to Buy** button. Or call 800-GO-EPSON (800-463-7766) in the U.S. or 800-807-7766 in Canada.

Note: Paper/media availability varies by country.

For the most updated list of supported Epson papers, visit proimaging.epson.com (U.S.) or proimaging.epson.ca (Canada).

Roll Paper

Note: When using 3-inch roll cores, this product supports only plain roll paper. Epson cannot guarantee feed or print quality for other media on 3-inch roll cores.

Paper Type	Size	Part number	Amount
Epson Singleweight Matte Paper	17 inches (432 mm) × 132 feet (40.2 m)	S041746	1 roll
	24 inches (610 mm) × 132 feet (40.2 m)	S041853	1 roll
	36 inches (914 mm) × 132 feet (40.2 m)	S041854	1 roll
Epson Doubleweight Matte Paper	24 inches (610 mm) × 132 feet (40.2 m)	S041385	1 roll
	36 inches (914 mm) × 132 feet (40.2 m)	S041386	1 roll
Epson Premium Luster Photo Paper (260)	8.3 inches (211 mm) × 32 feet (9.8 m)	S041408	1 roll
	13 inches (330 mm) × 32 feet (9.8 m)	S041409	1 roll
	10 inches (254 mm) × 100 feet (30.5 m)	S042077	1 roll
	16 inches (406 mm) × 100 feet (30.5 m)	S042079	1 roll
	20 inches (508 mm) × 100 feet (30.5 m)	S042080	1 roll
	24 inches (610 mm) × 100 feet (30.5 m)	S042081	1 roll
	36 inches (914 mm) × 100 feet (30.5 m)	S042082	1 roll
Epson Premium Semigloss Photo Paper (170)	24 inches (610 mm) × 100 feet (30.5 m)	S041393	1 roll
	36 inches (914 mm) × 100 feet (30.5 m)	S041394	1 roll

Paper Type	Size	Part number	Amount
Epson Premium Semimatte Photo Paper (250)	16 inches (406 mm) × 100 feet (30.5 m)	S042149	1 roll
	24 inches (610 mm) × 100 feet (30.5 m)	S042150	1 roll
	36 inches (914 mm) × 100 feet (30.5 m)	S042151	1 roll
Epson Premium Glossy Photo Paper (170)	16.5 inches (419 mm) × 100 feet (30.5 m)	S042076	1 roll
	24 inches (610 mm) × 100 feet (30.5 m)	S041390	1 roll
	36 inches (914 mm) × 100 feet (30.5 m)	S041391	1 roll
Epson Premium Glossy Photo Paper (250)	24 inches (610 mm) × 100 feet (30.5 m)	S041638	1 roll
	36 inches (914 mm) × 100 feet (30.5 m)	S041639	1 roll
Epson Enhanced Matte Paper	17 inches (432 mm) × 100 feet (30.5 m)	S041725	1 roll
	24 inches (610 mm) × 100 feet (30.5 m)	S041595	1 roll
	36 inches (914 mm) × 100 feet (30.5 m)	S041596	1 roll
Enhanced Adhesive Synthetic Paper	24 inches (610 mm) × 100 feet (30.5 m)	S041617	1 roll
Poster Paper Production (175)	17 inches (432 mm) × 175 feet (53.3 m)	S450225	1 roll
	24 inches (610 mm) × 175 feet (53.3 m)	S450226	1 roll
	36 inches (914 mm) × 175 feet (53.3 m)	S450227	1 roll

Paper Type	Size	Part number	Amount
Poster Paper Production (210)	17 inches (432 mm) × 200 feet (60.9 m)	S450230	1 roll
	24 inches (610 mm) × 200 feet (60.9 m)	S450231	1 roll
	36 inches (914 mm) × 200 feet (60.9 m)	S450232	1 roll

Cut Sheets

Paper Type	Size	Part number	Amount
Epson Ultra Premium Photo Paper Luster	Letter (8.5 × 11 inches [216 × 279 mm])	S041405	50 sheets
		S041913	250 sheets
Epson Premium Photo Paper Glossy	Letter (8.5 × 11 inches [216 × 279 mm])	S041667	50 sheets
Epson Premium Photo Paper Semi-gloss	Letter (8.5 × 11 inches [216 × 279 mm])	S041331	20 sheets
Epson Premium Presentation Paper Matte	Letter (8.5 × 11 inches [216 × 279 mm])	S041257	50 sheets
Epson Singleweight Matte Paper	13 × 19 inches (330 × 483 mm)	S041909	100 sheets
	17 × 22 inches (432 × 559 mm)	S041907	100 sheets

Parent topic: [Media Handling](#)

Paper or Media Type Settings - Printing Software

For this paper	Select this Paper Type or Media Type setting
Plain paper 16 to 20 lb (60 to 75 g/m ²)	Plain Paper
Epson Singleweight Matte Paper	Singleweight Matte Paper
Epson Doubleweight Matte Paper	Doubleweight Matte Paper
Epson Premium Presentation Paper Matte	Enhanced Matte Paper
	Archival Matte Paper

For this paper	Select this Paper Type or Media Type setting
Coated paper (generic)	Coated Paper (Generic)
Epson Premium Glossy Photo Paper (170)	Premium Glossy Photo Paper (170)
Epson Premium Semigloss Photo Paper (170)	Premium Semigloss Photo Paper (170)
Epson Premium Photo Paper Glossy	Premium Glossy Photo Paper
	Photo Paper Glossy
Epson Premium Photo Paper Semi-gloss	Premium Semigloss Photo Paper
Epson Premium Luster Photo Paper (260)	Premium Luster Photo Paper
Epson Ultra Premium Photo Paper Luster	
Photo paper (generic)	Photo Paper (Generic)
Tracing paper/vellum paper	Tracing Paper
	Tracing Paper <Low Duty>
	Matte Film
Enhanced Synthetic Paper	Enhanced Synthetic Paper
Enhanced Adhesive Synthetic Paper	Enhanced Adhesive Synthetic Paper
	Enhanced Low Adhesive Synthetic Paper
Polyester banner (generic)	Heavy Weight Polyester Banner
Backlight Film Roll	Backlight Film Roll
Blueprint paper	Blueprint Paper

Note: The settings listed here are available only when printing from your computer; they do not apply to your product's control panel settings.

Parent topic: [Media Handling](#)

Selecting the Paper Settings for Each Source - Control Panel

You can change the default paper size and paper type for each source using the control panel on the product.

1. Press the  home button, if necessary.

2. Select **Paper Setting**.

You see a screen like this:

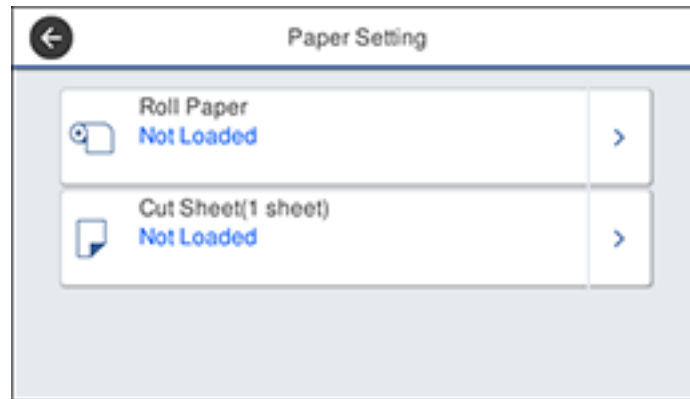

3. Select the paper source you want to select settings for.

You see a screen like this:

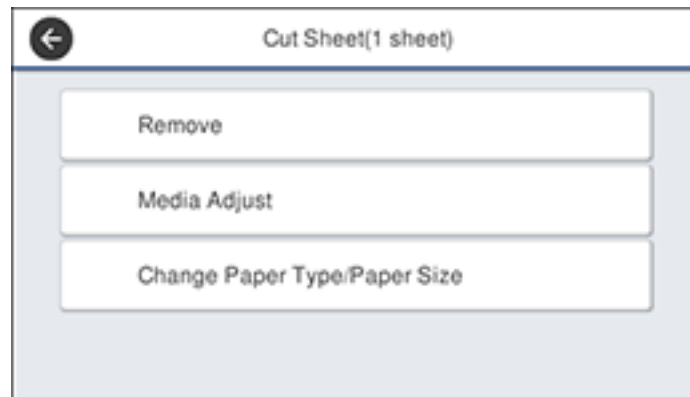

4. Select **Change Paper Type/Paper Size**.
5. Select **Paper Type**.
6. Select the paper type for the paper you loaded.

7. Select **Paper Size**.
8. Select the paper size you loaded.
9. Press the  home button to exit.

[Paper Type Settings - Control Panel](#)

Parent topic: [Media Handling](#)

Paper Type Settings - Control Panel

Select a **Paper Type** setting that matches the paper you loaded. If you do not see your paper type listed, select a general category such as **Others**.



For this paper	Select this Paper Type or Media Type setting
Plain paper 16 to 20 lb (60 to 75 g/m ²)	Plain Paper
Epson Singleweight Matte Paper	Singleweight Matte
Epson Doubleweight Matte Paper	Doubleweight Matte
Epson Premium Presentation Paper Matte	Enhanced Matte
	Archival Matte
Coated paper (generic)	Coated Paper (Generic)
Epson Premium Glossy Photo Paper (170)	Premium Glossy 170
Epson Premium Semigloss Photo Paper (170)	Premium Semigloss 170
Epson Premium Photo Paper Glossy	Premium Glossy Sheet
	Photo Paper Glossy
Epson Premium Photo Paper Semi-gloss	Premium Semigloss Sheet
Epson Premium Luster Photo Paper (260)	Premium Luster Sheet
Epson Ultra Premium Photo Paper Luster	
Photo paper (generic)	Photo Paper (Generic)
Tracing paper/vellum paper	Tracing Paper
	Tracing Paper <LowDuty>
	Matte Film
Enhanced Synthetic Paper	Enhanced Synthetic

For this paper	Select this Paper Type or Media Type setting
Enhanced Adhesive Synthetic Paper	Enhanced Adhesive Syn.
	Enhanced Low Adh. Syn.
Polyester banner (generic)	Heavyweight Polyester
Backlight Film Roll	Backlight Film Roll
Blueprint Paper	Blueprint Paper

Parent topic: [Selecting the Paper Settings for Each Source - Control Panel](#)

Creating Custom Paper Configurations

You can create and store up to 10 custom paper configurations for use if printing on non-Epson paper or paper that is not supported by the Epson printer driver.

1. Load the type of paper that you want to configure in the printer.
2. Press the  home button, if necessary.
3. Select **Settings > General Settings > Printer Settings > Custom Paper Setting**.
4. Select a number for the custom paper configuration.
5. Select **Change Name** and enter a name.
6. Select **OK** when you are done.
7. Select **Change Reference Paper**.
8. Select a paper type that is similar to the paper that you want to use.
9. Select **Advanced Media Setting**.
10. Select any additional settings as necessary.
11. When you finish changing the custom paper configuration settings, press the  home button to exit the menu.

[Selecting Custom Paper Configurations](#)

Parent topic: [Media Handling](#)

Selecting Custom Paper Configurations

Once you have created a custom paper configuration, you can select the configuration whenever you print on the associated media.

1. Press the  home button, if necessary.
2. Select the paper type you are printing on.

Note: If you do not have paper loaded in the printer, the printer will ask you to load paper before continuing.

3. Select **Change Paper Type** or **Change Paper Type/Paper Size**.
4. Select **Paper Type > Others > Custom Paper**.
5. Select the custom paper configuration you want to use.
6. Press the left arrow button to exit the menu.

Parent topic: [Creating Custom Paper Configurations](#)

Printing from a Computer

Before printing from your computer, make sure you have set up your product and installed its software as described on the *Start Here* sheet.

Note: If you have an Internet connection, it is a good idea to check for updates to your product software on Epson's support website. If you see a Software Update screen, select **Enable automatic checking** and click **OK**. The update scans your system to see if you have the latest product software. Follow the on-screen instructions.

[Printing with Windows](#)

[Printing with the Built-in Epson Driver - Windows 10 S](#)

[Printing on a Mac](#)

[Printing CAD Drawings](#)

Printing with Windows

You can print with your product using any Windows application, as described in these sections.

Note: If you are using your Epson product with the Windows 10 S operating system, you cannot use the software described in this section. You also cannot download and install any Epson product software from the Epson website for use with Windows 10 S; you must obtain software only from the Windows Store.

[Selecting Basic Print Settings - Windows](#)

[Selecting Print Layout Options - Windows](#)

[Selecting Advanced Settings - Windows](#)

[Selecting Additional Settings - Windows](#)

[Printing Your Document or Photo - Windows](#)

[Saving, Sharing, and Customizing the Printer Settings](#)

[Selecting Default Print Settings - Windows](#)

[Changing the Language of the Printer Software Screens](#)

[Changing Automatic Update Options](#)

Parent topic: [Printing from a Computer](#)

Selecting Basic Print Settings - Windows

Select the basic settings for the document you want to print.

1. Open a document for printing.
2. Select the print command in your application.

Note: You may need to select a print icon on your screen, the **Print** option in the File menu, or another command. See your application's help utility for details.

3. If necessary, select your product name as the printer you want to use.

Note: You may also need to select **Preferences**, **Properties**, **Print Settings**, or **Printer Properties** to view your print settings.

You see the Printer Settings window:

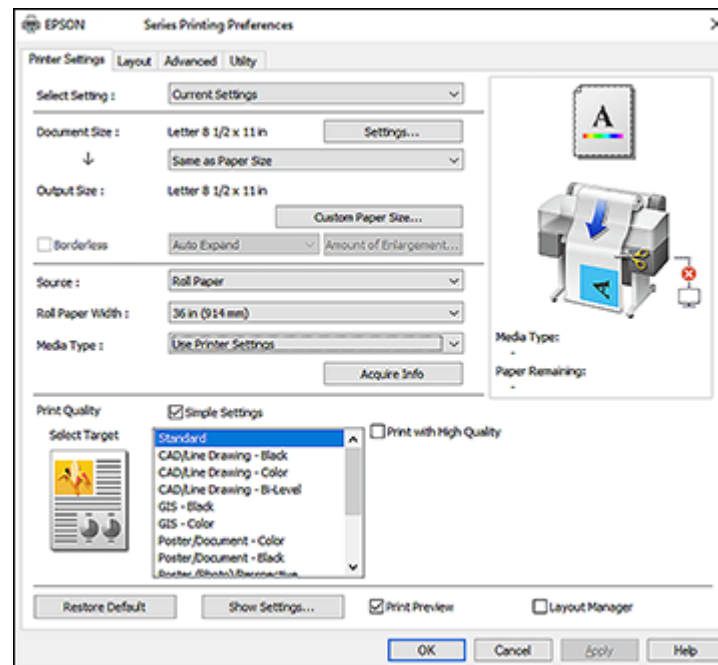

4. Select the **Current Settings** option or a custom setting.

5. Click **Settings** to select the **Document Size** setting that matches the size of the document you are printing.
6. If you want your printout to be a different size than the selected document size, select the **Output Size** setting.

Note: If you select **Fit to Output Size**, you can select a different output size. If you select **Same as Paper Size**, the **Document Size** and **Output Size** settings are the same.

Note: Select **Custom Paper Size** to set a user-defined output size.

7. If you are printing a borderless photo, select **Borderless**. You can select **Amount of Enlargement** to access additional options for borderless printing.
8. Select the **Source** setting that matches the paper source you are using.

Note: If you select **Roll Paper**, select the width of the roll as the **Roll Paper Width** setting.

9. Select the **Media Type** setting that matches the paper you loaded.

Note: If you want to use paper settings that have been set in the printer's control panel, select **Use Printer Settings**.

Note: Click **Acquire Info** to refresh the settings if you loaded or changed paper after opening the print window.

10. Select the **Select Target** setting that matches the type of document you are printing.

Note: If you want the printer driver to determine print settings based on the document type, select the **Simple Settings** checkbox. Deselect the checkbox if you want to select your own color correction, print mode, or other settings.

11. If you want to prioritize quality over print speed, select the **Print with High Quality** checkbox.
12. If you deselect the **Simple Settings** checkbox, the following options are available:
 - **Print Mode:** choose a printout color
 - **Color Mode:** choose a color mode to fine-tune printout colors
 - **Level:** choose speed or quality as the printing priority
 - **High Speed:** select to speed up printing, but quality may be reduced

- **Finest Detail:** select to smooth out jagged edges in low-resolution images

Note: The **Finest Detail** setting may reduce print speed, especially if the printer is connected wirelessly. Use a wired connection if you enable this setting.

Note: Available options depend on the selected **Select Target** setting.

13. To see a preview of how your document will print, select **Print Preview**. (The preview appears after you click **Print** but before printing starts.)
14. To layout multiple print data or images for printing all at once, select **Layout Manager**.

[Document Size Options - Windows](#)

[Paper Source Options - Windows](#)

[Print Mode Options - Windows](#)

[Color Mode Options - Windows](#)

[Level Options - Windows](#)

[Using Layout Manager - Windows](#)

Parent topic: [Printing with Windows](#)

Related tasks

[Printing Your Document or Photo - Windows](#)

Document Size Options - Windows

You can select any of the Document Size options to size your printed image.

Same as Paper Size

Sizes your printed image to fit the selected paper size.

Fit to Roll Paper Width

Sizes your printed image to fit the width of the roll paper you loaded.

Fit to Output Size

Sizes your printed image to fit the selected output size.

Others

Sizes your printed image to a specified size.

Parent topic: [Selecting Basic Print Settings - Windows](#)

Paper Source Options - Windows

You can select any of the available options in the Source menu to print on the paper loaded in that source.

Roll Paper

Selects roll paper loaded in the roll paper holder.

Sheet

Selects the cut sheet loaded in the paper feeder.

Parent topic: [Selecting Basic Print Settings - Windows](#)

Print Mode Options - Windows

You can select a Print Mode option to determine the color of your printouts.

Color

Select to print your document in color.

Black

Select to print your document in black and white (grayscale is supported).

Black (Bi-Level)

Select to print CAD drawings in black and white (grayscale is not supported).

Colored Paper (Yellow)

Select if you are printing your document on yellow paper. This option is used for some poster applications.

Parent topic: [Selecting Basic Print Settings - Windows](#)

Color Mode Options - Windows

You can adjust the **Color Mode** setting to fine-tune the colors in your printout or turn off color management in your printer software.

EPSON Standard (sRGB)

Optimizes the sRGB space and corrects the color.

Business Graphics

Performs color correction to optimize your images based on the sRGB space.

Line Drawing

Optimizes color correction for line drawings by processing the border between lines and the background as discontinuous.

GIS

Performs optimal printing for topographic maps and other geographic information system (GIS) data.

ICM

Automatically adjusts colors based on the printer's ICC profile and the selected **Media Type** setting, using the Image Color Matching system. Click the **Advanced** button to choose the input profile and other settings.

Note: In most cases, you get better results by applying color management in your application, rather than in the printer driver.

Off (No Color Adjustment)

Turns off color management in your printer software so you can manage color using only your application software.

Note: An ICC profile is required if color management is turned off.

Click **Settings** to open the **Color Controls** window, where you can specify values for adjusting brightness, contrast, saturation, and individual Cyan, Magenta, and Yellow color tones. You can choose from two Gamma settings, and use either a color circle or slide bar to adjust color.

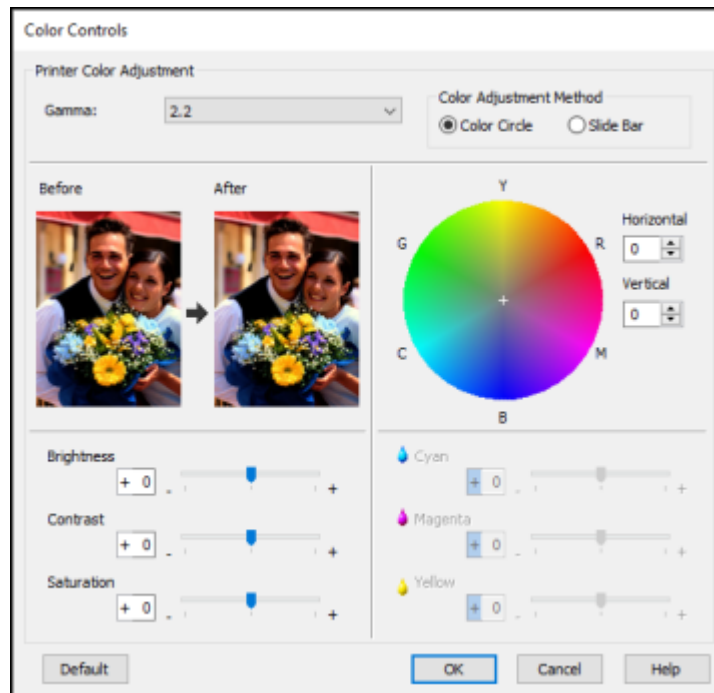

Parent topic: [Selecting Basic Print Settings - Windows](#)

Level Options - Windows

You can select a print speed or print quality priority for your printouts.

Speed

Select to prioritize print speed over print quality; quality may be reduced.

Quality

Select to prioritize print quality over print speed.

Max Quality

Select to use the maximum print quality; print speed may be slower.

Quality Options

Select print speed or print quality levels using a slider.

Parent topic: [Selecting Basic Print Settings - Windows](#)

Using Layout Manager - Windows

Layout Manager lets you include multiple pieces of print data created in different applications onto one sheet of paper for printing.

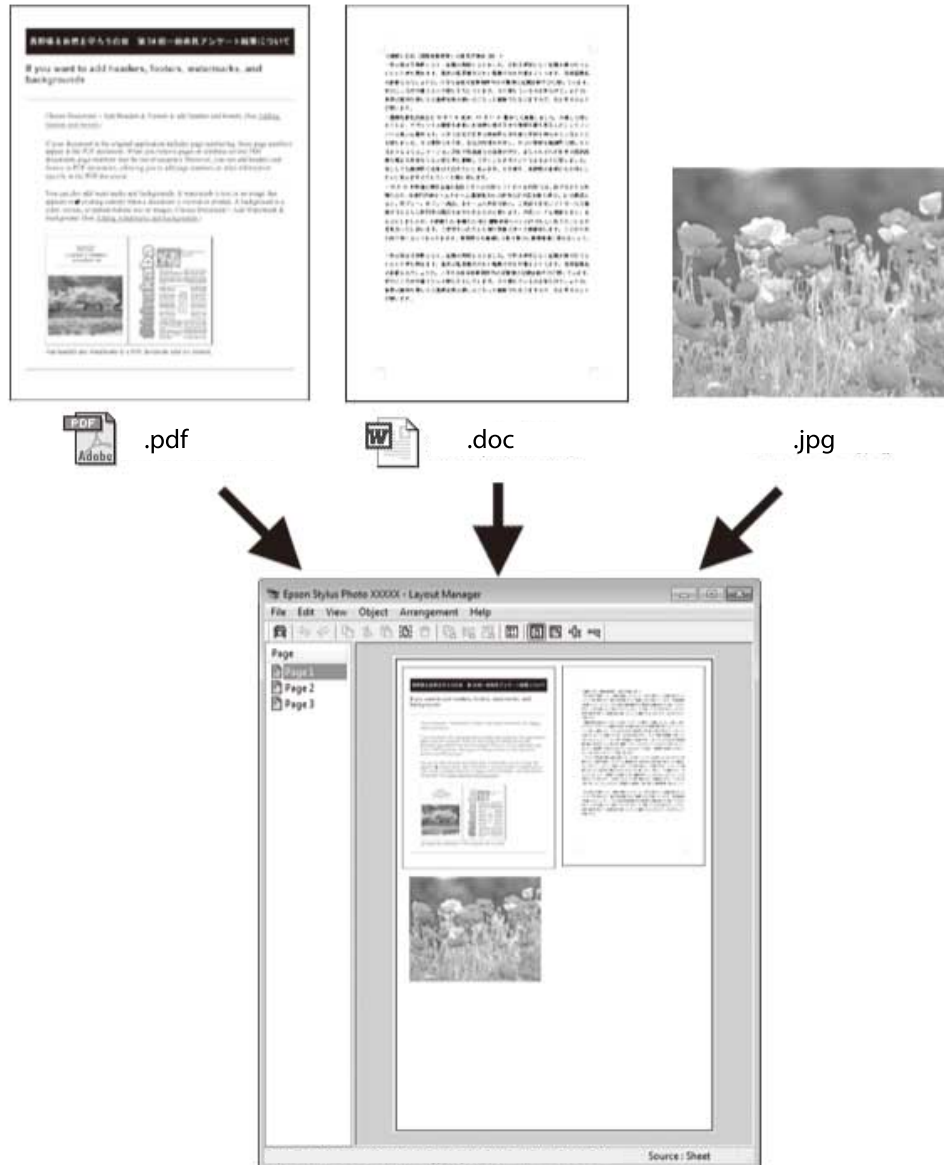

You can also place the same print data multiple times as shown here.

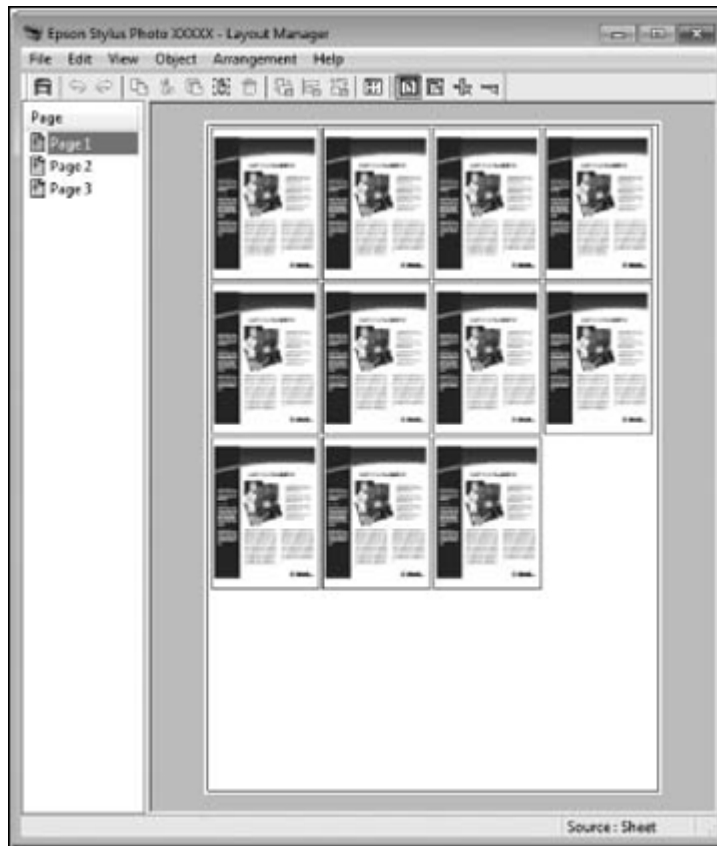

You can place print data in different sizes and orientations to maximize media usage, as shown here.

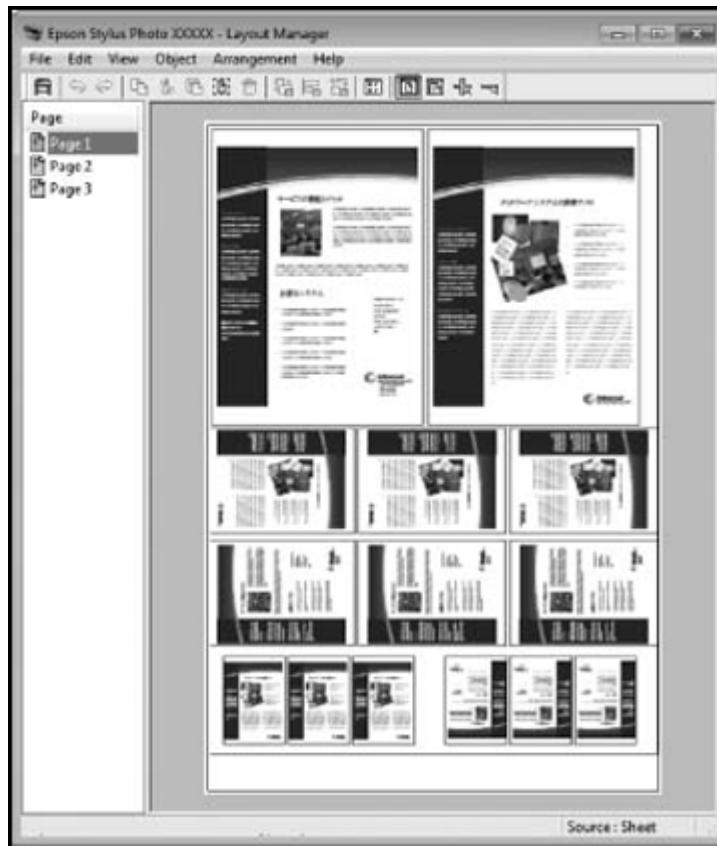

You can place print data on roll paper as shown here.

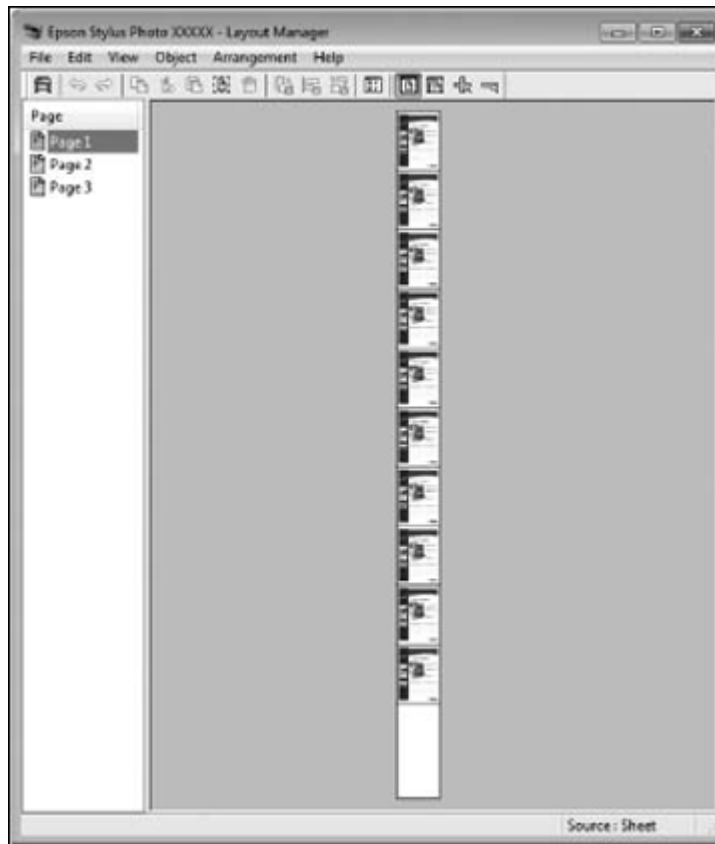

1. Open the file you want to print in your application.
2. Select the print command in your application.
3. Select the **Layout Manager** checkbox on the Printer Settings tab.
4. Choose an option for the **Document Size** setting that matches the size of the document in your application.
5. Click **OK** and then click **Print**, if necessary.

The Layout Manager screen opens and displays one page in the layout.

6. Leave the Layout Manager screen open and repeat steps 1 to 4 to arrange additional print data. The pages are added to the Layout Manager screen.
7. Do the following to arrange objects on the Layout Manager screen:
 - Drag pages to move and resize them.
 - Use the tool buttons and the Object menu to align and rotate pages.
 - Resize and replace whole pages in the Preference or Arrangement Settings screens.

Note: See the Layout Manager screen help for details.

8. Click **File > Properties** and select your print settings, including the size of the paper you are printing on.
9. Open the **File** menu on the Layout Manager screen and click **Print**.

Note: To save the current job to a file, open the **File** menu on the Layout Manager screen, save the file, and close the Layout Manager screen. To open the saved file later for editing or reprinting, right-click the printer icon in the Windows taskbar, click **Layout Manager**, and select the file.

Parent topic: [Selecting Basic Print Settings - Windows](#)

Selecting Print Layout Options - Windows

You can select a variety of layout options for your document on the Layout tab.

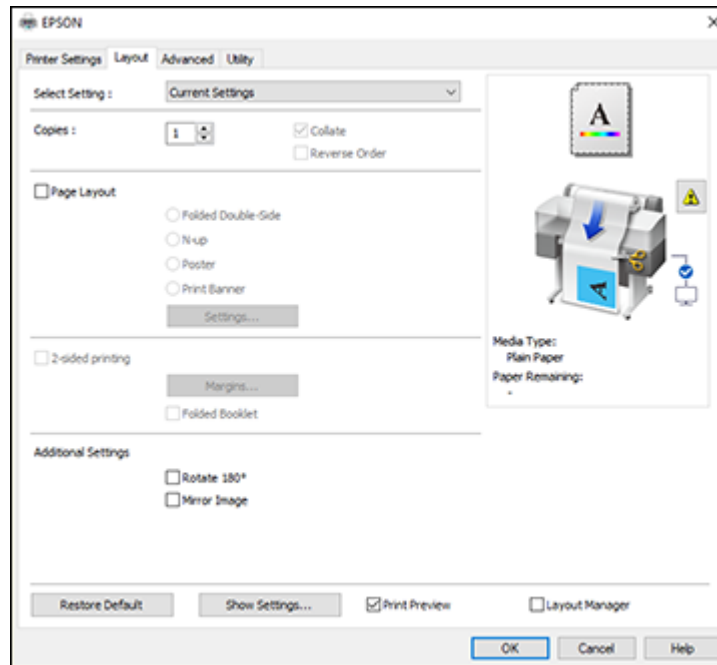

- To select multiple copies and their print order, select the **Copies**, **Collate**, and **Reverse Order** options.
- To print multiple pages on one sheet of paper, or print one image on multiple sheets of paper, select the **Page Layout** checkbox and select the option you want.
- To print on both sides of the paper, select the **2-sided Printing** checkbox and select the options you want.
- To rotate or flip the printed image, select the **Rotate 180°** or **Mirror Image** checkbox.

[Page Layout Options - Windows](#)

Parent topic: [Printing with Windows](#)

Page Layout Options - Windows

You can select these Page Layout options to set up your multi-page print job.

Note: Available options depend on the **Paper Source** setting.

Folded Double-Side

Prints two consecutive pages on one sheet of paper. The second page is flipped and printed next to the first page, allowing the sheet to be folded to make a 2-sided document. Click **Settings** to select a binding edge option and set margins.

N-up

Prints 2 (**2-up**) or 4 (**4-up**) pages on one sheet of paper. Click **Settings** to choose the number of pages per sheet and set the page order.

Poster

Prints one image on multiple sheets of paper to create a large poster. Click the **Settings** button to select the layout and guideline options.

Print Banner

Select when using a Windows application designed for banners.

Parent topic: [Selecting Print Layout Options - Windows](#)

Selecting Advanced Settings - Windows

You can select advanced printing settings on the Advanced tab.

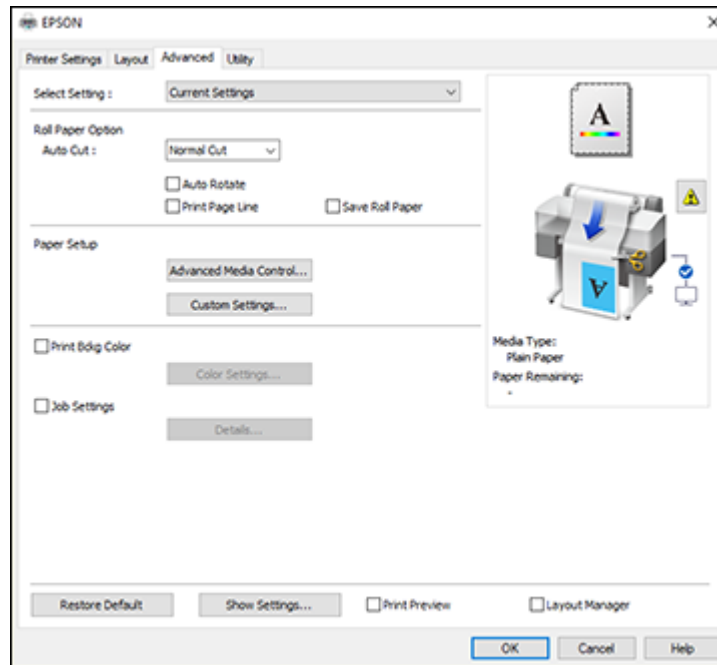

- To control how roll paper is cut after printing, select an **Auto Cut** option. Select other roll paper options as necessary.
- To print on cut sheet paper with 14 mm margins above and below your print, select **Vertical Centering**.

Note: This setting is only available when the **Source** setting is set to **Cut Sheet (1 sheet)**.

- To adjust the ink saturation level, select **Advanced Media Control**.
- To create or edit custom printing settings, select **Custom Settings**.
- To print a color background on the page, select the **Print Bkg Color** checkbox and click **Color Settings** to select the color you want to use.

- To print the time, date, and other information about your print job at the top or bottom of the page, select the **Job Settings** checkbox and click **Details** to select the settings you want to use.

[Roll Paper Options - Windows](#)

Parent topic: [Printing with Windows](#)

Roll Paper Options - Windows

Select any of the available roll paper options.

Note: Some settings may not be available, depending on the Roll Paper Option you selected for your paper size.

Auto Cut

- **Off:** Select this option to cut your prints manually.
- **Normal Cut:** Creates a margin at the top and bottom of your image and automatically cuts the paper. These margins vary by media type and may be changed from their defaults using custom media settings.

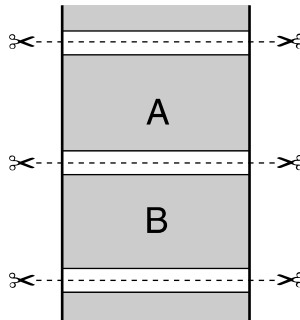

- **Single Cut:** Prints images end-to-end with no gap between them. Borderless images may overlap slightly.

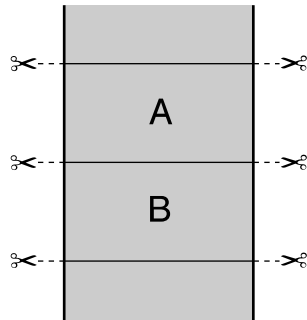

- **Double Cut:** Increases the space between each image and trims each print individually, providing the cleanest edge for borderless printing.

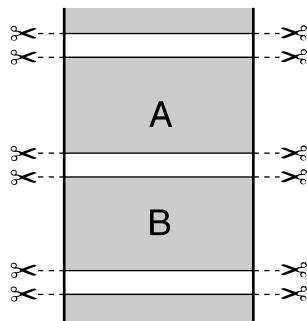

Auto Rotate

Automatically positions the image or print data to fit the roll paper.

Print Page Line

Prints lines between pages as a guide for manual cutting.

Save Roll Paper

When Auto Cut is enabled, the printer cuts the roll paper at the end of the image as positioned on the page.

Parent topic: [Selecting Advanced Settings - Windows](#)

Selecting Additional Settings - Windows

You can run maintenance utilities and select additional settings that apply to all your print jobs on the Utility tab.

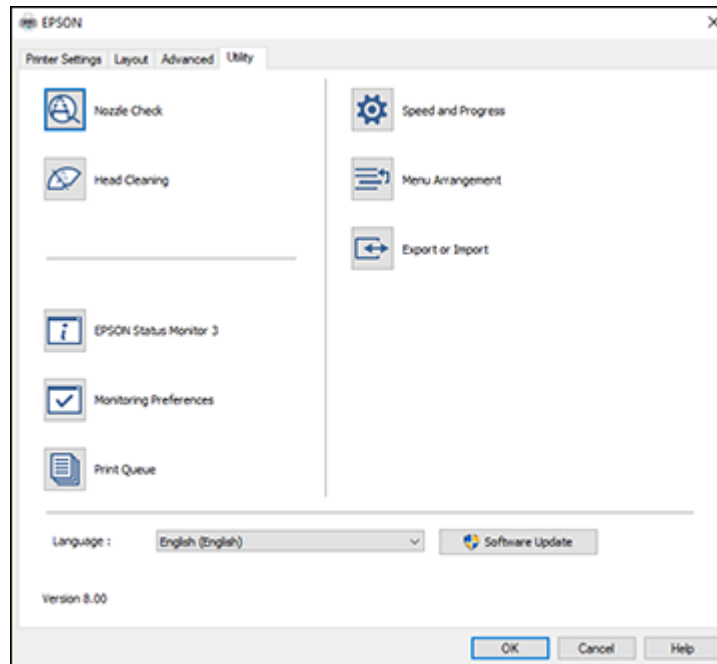

- Click **Nozzle Check** to print a nozzle check pattern to check whether the print head nozzles are clogged.
- Click **Head Cleaning** to clean the print head if you notice banding or gaps in your printouts.
- Click **Epson Status Monitor 3** to check the printer's status.
- Click **Monitoring Preferences** to select the error notifications displayed on the Epson Status Monitor 3 screen, or add a shortcut to the utility in the Windows taskbar.
- Click **Print Queue** to display a list of all waiting print jobs, view information on the data waiting to be printed, and delete or reprint the jobs.
- Click **Speed and Progress** to select various printing options.

- Click **Menu Arrangement** to arrange the **Select Setting**, **Media Type**, and **Paper Size** options by frequency of use.
- Click **Export or Import** to save the print settings to a file or import them from a file. This is useful when you want to select the same print settings on multiple computers.
- Select a **Language** option for the language you want to use for the printer software screens.

Parent topic: [Printing with Windows](#)

Related tasks

[Checking the Nozzles Using a Computer Utility](#)

[Cleaning the Print Head Using a Computer Utility](#)

Printing Your Document or Photo - Windows

Once you have selected your print settings, you are ready to save your settings and print.

1. Click **OK** to save your settings.

You see your application's Print window, such as this one:

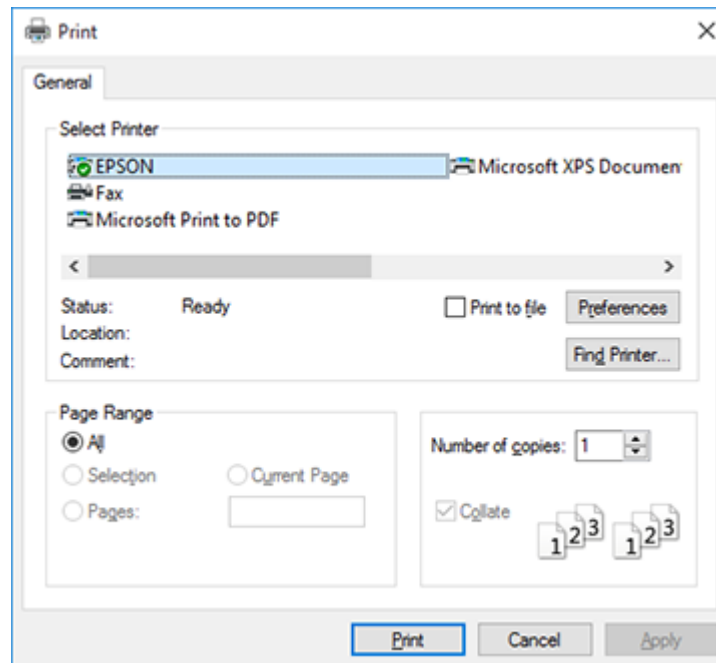

2. Click **OK** or **Print** to start printing.

[Checking Print Status - Windows](#)

Parent topic: [Printing with Windows](#)

Checking Print Status - Windows

During printing, you see this window showing the progress of your print job. It allows you to control printing and check ink cartridge status.

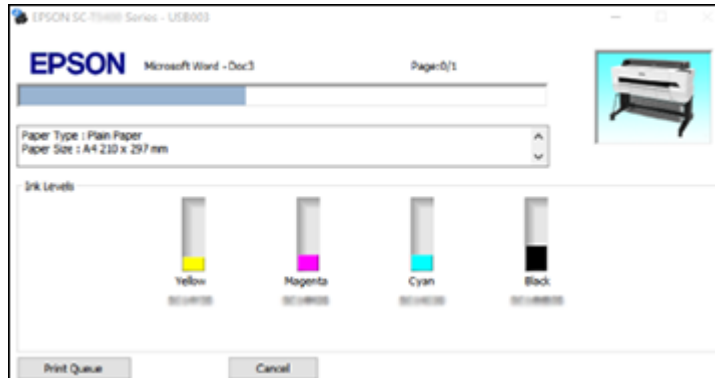

- To cancel printing, click **Cancel**.
- To see print jobs waiting to print, click **Print Queue**.

Parent topic: [Printing Your Document or Photo - Windows](#)

Saving, Sharing, and Customizing the Printer Settings

You can save groups of print settings or media settings so you can reuse them for future print jobs. You can export these settings as a file so you can share them with other users. You can also edit the settings displayed in the printer software screens.

[Saving and Sharing Print Settings - Windows](#)

[Editing Print Setting Displays - Windows](#)

Parent topic: [Printing with Windows](#)

Saving and Sharing Print Settings - Windows

You can save your print settings so you can use them for future print jobs.

1. Make sure the selected settings on the Printer Settings, Layout, and Advanced tabs are set to what you want to save.
2. Under the Select Setting dropdown menu, select **Custom Settings**.

You see a window like this:

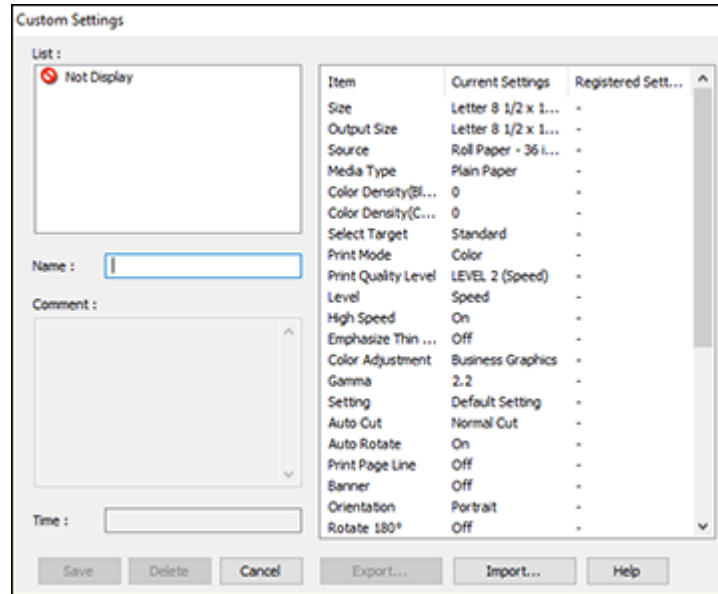

3. Verify that your settings are correct, enter a name for the group of settings in the **Name** field, and click **Save**.
4. Do the following as necessary:
 - If you need to delete a group of settings you have created, select the name of the group of settings from the list and click **Delete**.
 - To export the settings, select the name of the group of settings, click **Export**, select a location, and enter a file name.
 - To import a group of settings, click **Import**, select the file you want to use, and click **Open**. Then use the settings to print.

Once custom settings are saved, you can select the name of the group of settings from the Select Setting dropdown menu and use them to print.

Parent topic: [Saving, Sharing, and Customizing the Printer Settings](#)

Related tasks

[Selecting Basic Print Settings - Windows](#)

[Printing Your Document or Photo - Windows](#)

Editing Print Setting Displays - Windows

You can arrange the displayed print settings so you can easily select the settings you use most often.

1. Click the **Utility** tab in the printer software.
2. Select **Menu Arrangement**.

You see this window:

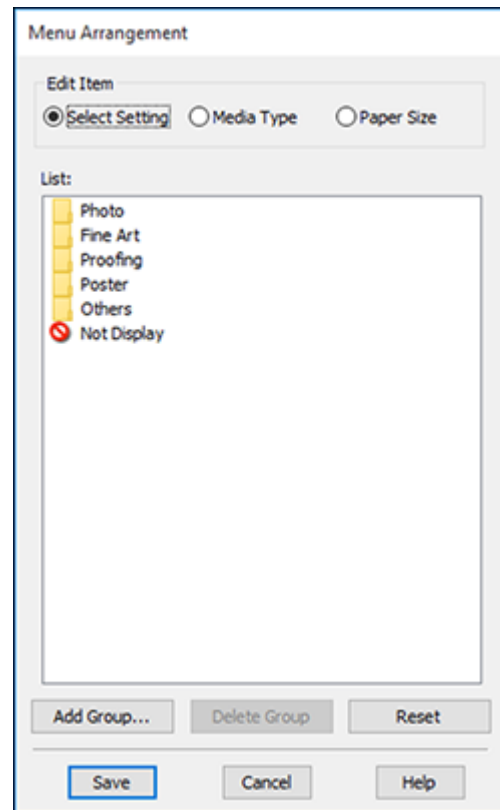

3. Select the item you want to edit.
4. Order or group items in the **List** box as follows:
 - To move and reorder items, drag and drop them in the list.
 - To add a new group (folder), click **Add Group**.
 - To delete a group (folder), select the group and click **Delete Group**.
 - To hide a group, drag and drop it to **Not Display**.



Note: If you delete a group, the group folder is deleted but the items within the folder remain.

5. Click **Save**.

Parent topic: [Saving, Sharing, and Customizing the Printer Settings](#)

Selecting Default Print Settings - Windows

When you change your print settings in a program, the changes apply only while you are printing in that program session. If you want to change the print settings you use in all your Windows programs, you can select new default print settings.

1. Access the Windows Desktop and right-click the  icon for your product in the right side of the Windows taskbar, or click the up arrow and right-click .
2. Select **Printer Settings**.

You see the printer settings window:

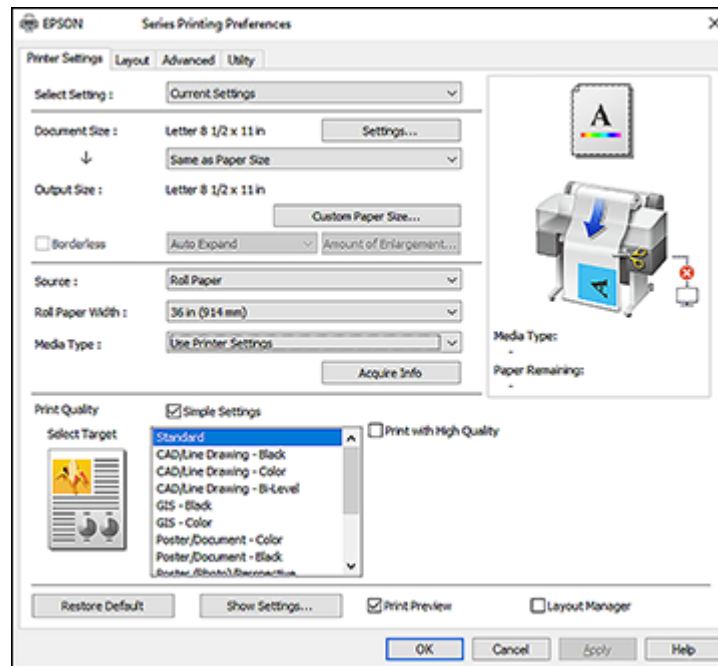

3. Select the print settings you want to use as defaults in all your Windows programs.
4. Click **OK**.

These settings are now the defaults selected for printing. You can still change them as needed for printing in any program session.



Parent topic: [Printing with Windows](#)

Related tasks

[Selecting Basic Print Settings - Windows](#)

Changing the Language of the Printer Software Screens

You can change the language used on the Windows printer software screens.

1. Access the Windows Desktop and right-click the  icon for your product in the right side of the Windows taskbar, or click the up arrow and right-click .

2. Select **Printer Settings**.
You see the printer settings window.
3. Click the **Utility** tab.
You see these options:

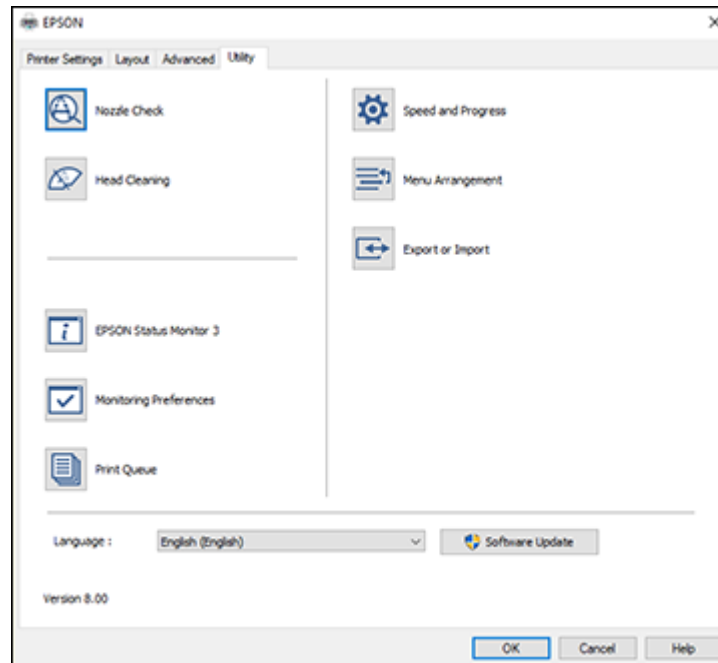



4. Select the language you want to use as the **Language** setting.
5. Click **OK** to close the printer software window.

The printer software screens appear in the language you selected the next time you access them.

Parent topic: [Printing with Windows](#)

Changing Automatic Update Options

Your printer software for Windows automatically checks for updates to the product software. You can change how often the software checks for updates or disable this feature.

1. Access the Windows Desktop and right-click the  icon for your product in the right side of the Windows taskbar, or click the up arrow and right-click .
2. Select **Software Update Settings**.

You see this window:

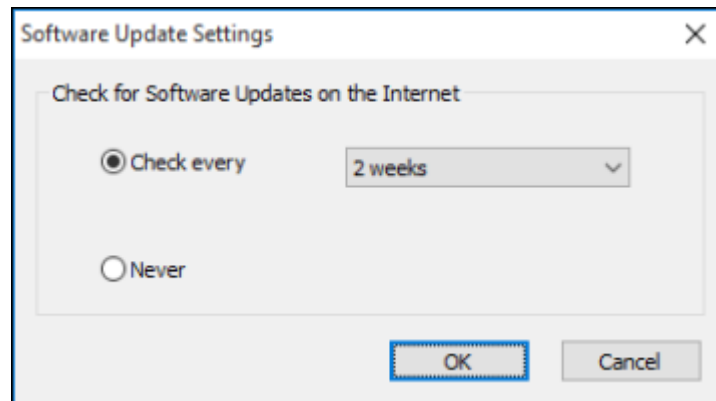

3. Do one of the following:
 - To change how often the software checks for updates, select a setting in the **Check every** menu.
 - To disable the automatic update feature, select the **Never** option.
4. Click **OK** to exit.

Note: If you choose to disable the automatic update feature, you can check for updates manually.

Parent topic: [Printing with Windows](#)

Printing with the Built-in Epson Driver - Windows 10 S

You can print with the built-in Epson printer driver using any printing program on Windows 10 S, as described in these sections.

Note: The built-in Epson driver in Windows 10 S does not include all the available print settings for your product. To print with additional settings, download and install the Epson Print and Scan utility from the Windows Store. You cannot download and install any Epson product software from the Epson website for use with Windows 10 S; you must obtain software only from the Windows Store.

Selecting Print Settings - Windows 10 S

Parent topic: [Printing from a Computer](#)

Selecting Print Settings - Windows 10 S

Select the settings for your print job in your Windows 10 S application.

1. Open a photo or document for printing.
2. Select the print command in your application.

Note: You may need to select a print icon on your screen, the **Print** option in the **File** menu, or another command. See your application's help utility for details.

3. If necessary, select your product name as the printer you want to use.

Note: You may also need to select **Properties** or **Preferences** to view your print settings.

You see a window like this:

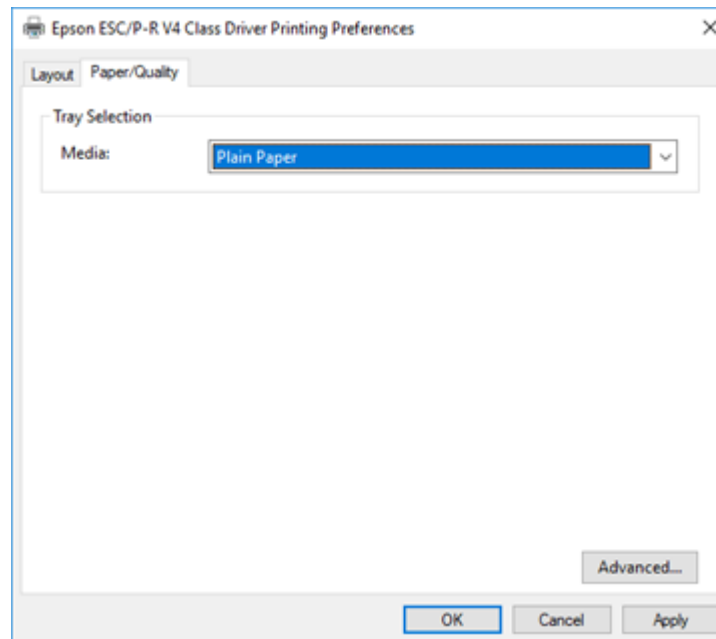

4. Select the type of paper you loaded as the **Media** setting.

Note: The setting may not exactly match the name of your paper. Check the paper type settings list for details.

5. Click the **Advanced** button.

You see a window like this:

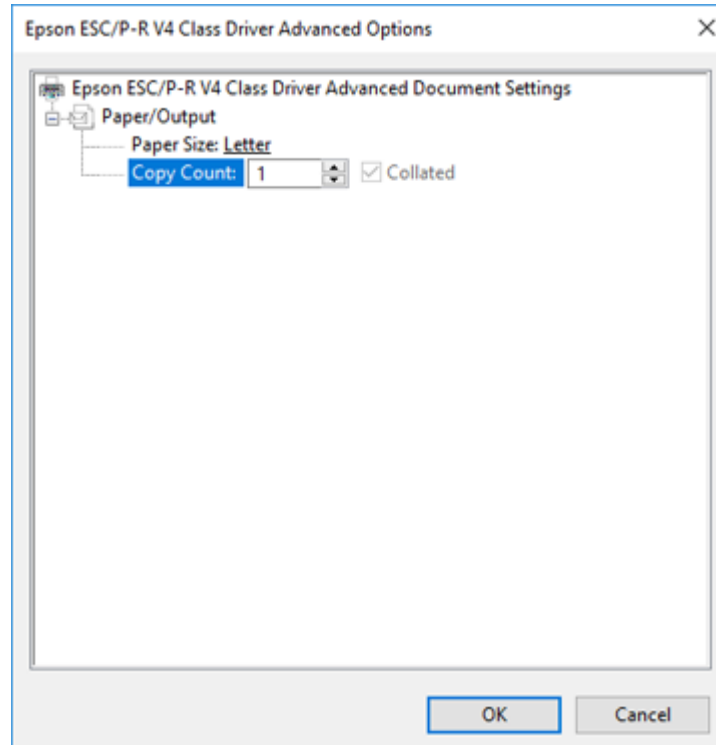

6. Select the size of the paper you loaded as the **Paper Size** setting.
7. To print multiple copies, select or enter the number as the **Copy Count** setting.
8. To print multiple copies of multi-page documents in sets, select the **Collated** checkbox.
9. Click **OK**.

You return to the printing preferences window.

10. Select the **Layout** tab.

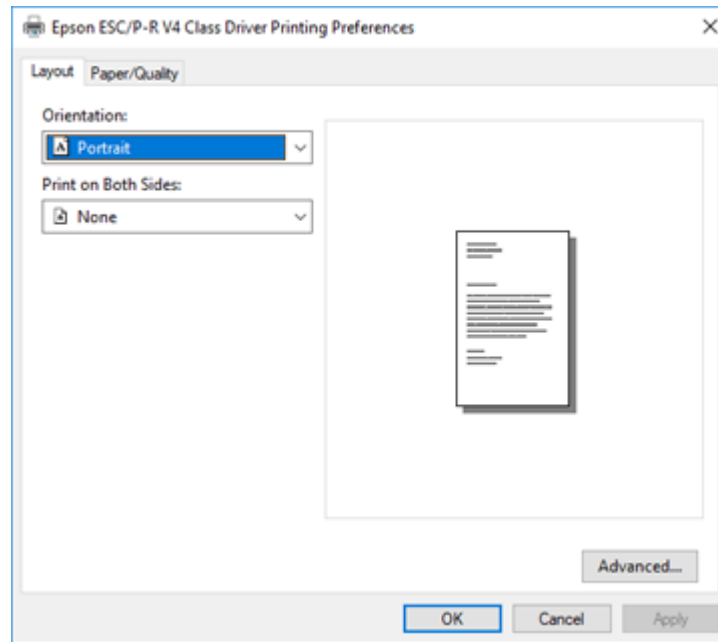

11. Select the orientation of your document as the **Orientation** setting.

12. Click **OK** to save your settings.

You see your application's **Print** window.

13. Click **OK** or **Print** to start printing.

Parent topic: [Printing with the Built-in Epson Driver - Windows 10 S](#)

Printing on a Mac

You can print with your product using any Mac printing program, as described in these sections.

Note: If you have an Internet connection, it is a good idea to check for updates to your product software on Epson's support website.

[Selecting Basic Print Settings - Mac](#)

[Selecting Print Layout Options - Mac](#)

[Selecting Advanced Settings - Mac](#)

[Managing Color - Mac](#)

[Sizing Printed Images - Mac](#)

[Selecting Printing Preferences - Mac](#)

[Printing Your Document - Mac](#)

Parent topic: [Printing from a Computer](#)

Selecting Basic Print Settings - Mac

Select the basic settings for the document you want to print.

1. Open a document for printing.
2. Select the print command in your application.

Note: You may need to select a print icon on your screen, the **Print** option in the File menu, or another command. See your application's help utility for details.

3. Select your product as the **Printer** setting.

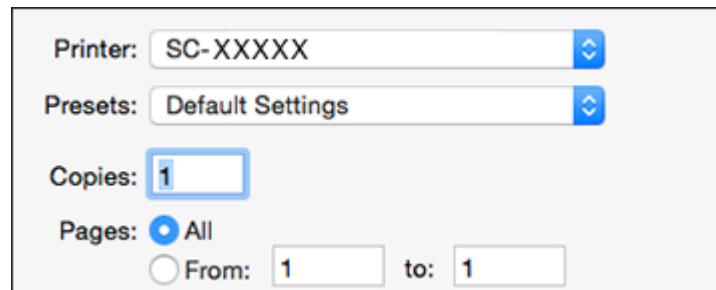

The image shows a screenshot of a Mac print dialog box. It contains the following settings:

- Printer:** A dropdown menu showing "SC-XXXXX" with a blue arrow icon on the right.
- Presets:** A dropdown menu showing "Default Settings" with a blue arrow icon on the right.
- Copies:** A text input field containing the number "1".
- Pages:** A radio button labeled "All" is selected. Below it, there is an unselected radio button labeled "From:" followed by a text input field containing "1", and the word "to:" followed by another text input field containing "1".

4. If necessary, click the arrow next to the Printer setting or the **Show Details** button to expand the print window.

You see the expanded printer settings window for your product:

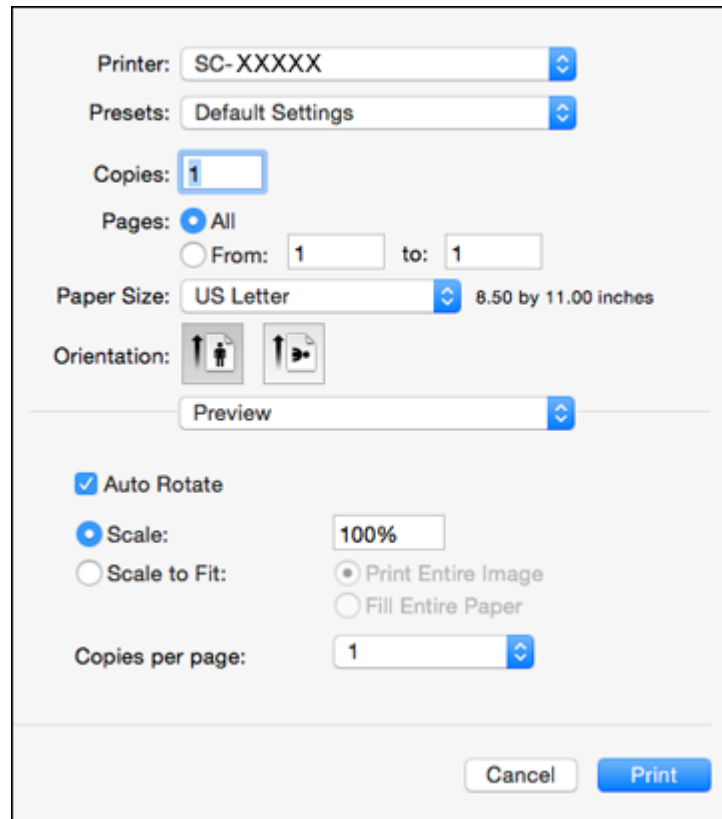

The image shows a Mac OS printer settings dialog box. At the top, there are dropdown menus for 'Printer' (set to 'SC-XXXXX') and 'Presets' (set to 'Default Settings'). Below these are input fields for 'Copies' (set to '1') and 'Pages' (with 'All' selected). The 'Paper Size' is set to 'US Letter' (8.50 by 11.00 inches). There are two orientation icons, with the first one selected. A 'Preview' dropdown is also present. In the lower section, there is a checked 'Auto Rotate' checkbox, a 'Scale' section with 'Scale' selected and '100%' entered, and a 'Scale to Fit' section with 'Print Entire Image' selected. At the bottom, there is a 'Copies per page' dropdown set to '1'. 'Cancel' and 'Print' buttons are at the very bottom.

Note: The print window may look different, depending on the Mac OS version and the application you are using.

5. Select the **Copies** and **Pages** settings as necessary.

Note: If you do not see these settings in the print window, check for them in your application before printing. They may be accessible by selecting **Page Setup** from the File menu.

6. Select the size of the paper you loaded as the **Paper Size** setting.

Note: You can reduce or enlarge the size of the printed image by selecting **Paper Handling** from the pop-up menu and selecting a scaling option. If you want to print a borderless print, select a paper size with **Borderless** in the name.

7. Choose portrait or landscape as the **Orientation** setting.
8. Select **Printer Settings** from the pop-up menu.

Note: In certain programs, you may need to select **Advanced** before you can select **Printer Settings**. For more information about printer settings, click the ? button.

You see a screen like this:

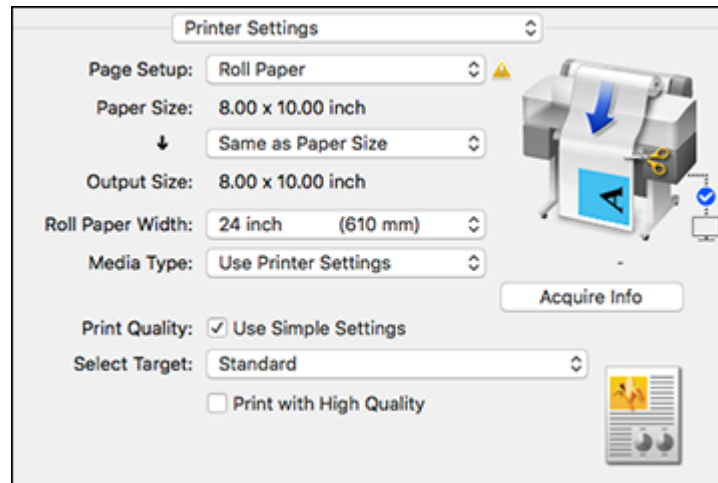

Note: Depending on the Mac OS version you are using, you may not see a **Printer Settings** option. If not, select **Printer Features** from the pop-up menu and scroll down to view all of the driver options.

9. If necessary, select the **Page Setup** setting that matches the paper source you are using..

Note: If you select **Roll Paper**, select the width of the roll as the **Roll Paper Width** setting.

10. If you want your printout to be a different size than the displayed Paper Size setting, select the **Output Size** setting in the dropdown menu.

Note: Select **Specify Size** to set a user-defined output size.

11. Select the **Media Type** setting that matches the paper you loaded.

Note: If you want to use paper settings that have been set in the printer's control panel, select **Use Printer Settings**.

Note: Click **Acquire Info** to refresh the settings if you loaded or changed paper after opening the print window.

12. Select the **Select Target** setting that matches the document you are printing.

Note: If you want the printer driver to determine print settings based on the document type, select the **Simple Settings** checkbox. Deselect the checkbox if you want to select your own color correction, print mode, or other settings.

13. If you want to prioritize quality over print speed, select **Print with High Quality** .

14. If you deselect the **Simple Settings** checkbox, the following options are available:

- **Color:** choose a printout color
- **Color Mode:** choose a color mode to fine-tune printout colors
- **Level:** choose speed or quality as the printing priority
- **High Speed:** select to speed up printing, but quality may be reduced
- **Emphasize Thin Lines:** select to smooth out jagged edges in low-resolution images

Note: The **Emphasize Thin Lines** setting may reduce print speed, especially if the printer is connected wirelessly. If you enable this setting, use a wired connection.

Note: Available options depend on the selected **Select Target** setting.

15. To see a preview of how your document will print, select **Print Preview**. (The preview appears after you click **Print** but before printing starts.)

[Paper Size Options - Mac](#)

[Paper Source Options - Mac](#)

[Print Mode Options - Mac](#)

[Color Mode Options - Mac](#)

[Level Options - Mac](#)

Parent topic: [Printing on a Mac](#)

Related tasks

[Selecting Advanced Settings - Mac](#)

[Printing Your Document - Mac](#)

Paper Size Options - Mac

You can select any of the Paper Size options in the Printer Settings menu to size your printed image.

Same as Paper Size

Sizes your printed image to fit the selected paper size.

Fit to Roll Paper Width

Sizes your printed image to fit the width of the roll paper you loaded.

Output Size

Sizes your printed image to fit the selected output size.

Specify Size

Sizes your printed image to a specified size.

Retain Scale

Retains the size of the original image.

Banner

Select when using an application designed for banners.

Parent topic: [Selecting Basic Print Settings - Mac](#)

Paper Source Options - Mac

You can select any of the available options in the Source menu to print on the paper loaded in that source.

Roll Paper

Selects roll paper loaded in the roll paper holder.

Sheet

Selects the cut sheet loaded in the paper feeder.

Parent topic: [Selecting Basic Print Settings - Mac](#)

Print Mode Options - Mac

You can select a Print Mode option to determine the color of your printouts.

Color

Select to print your document in color.

Black/Grayscale

Select to print your document in black and white (grayscale is supported).

Black (Bi-Level)

Select to print CAD drawings in black and white (grayscale is not supported).

Colored Paper (Yellow)

Select if you are printing your document on yellow paper. This option is used for some poster applications.

Parent topic: [Selecting Basic Print Settings - Mac](#)

Color Mode Options - Mac

You can adjust the **Color Mode** setting to fine-tune the colors in your printout or turn off color management in your printer software.

EPSON Standard (sRGB)

Optimizes the sRGB space and corrects the color.

Business Graphics

Performs color correction to optimize your images based on the sRGB space.

Line Drawing

Optimizes color correction for line drawings by processing the border between lines and the background as discontinuous.

GIS

Performs optimal printing for topographic maps and other geographic information system (GIS) data.

Off (No Color Adjustment)

Turns off color management in your printer software so you can manage color using only your application software.

Note: An ICC profile is required if color management is turned off.

Click **Settings** to open the **Color Controls** window, where you can specify values for adjusting brightness, contrast, saturation, and individual Cyan, Magenta, and Yellow color tones. You can choose from two Gamma settings, and use either a color circle or slide bar to adjust color.

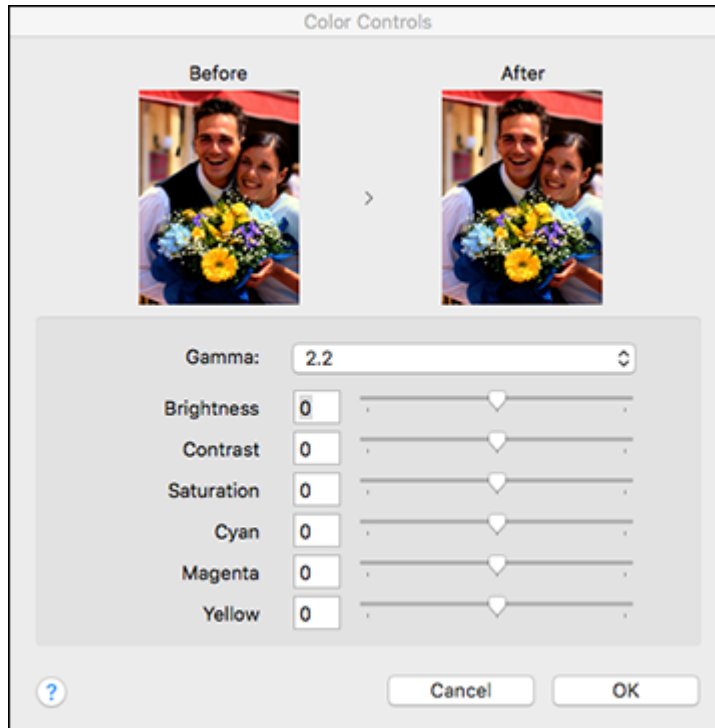

Parent topic: [Selecting Basic Print Settings - Mac](#)

Level Options - Mac

You can select a print speed or print quality priority for your printouts.

Speed

Select to prioritize print speed over print quality; quality may be reduced.

Quality

Select to prioritize print quality over print speed.

Max Quality

Select to use the maximum print quality; print speed may be slower.

Parent topic: [Selecting Basic Print Settings - Mac](#)

Selecting Print Layout Options - Mac

You can select a variety of layout options by selecting **Layout** from the pop-up menu on the print window.

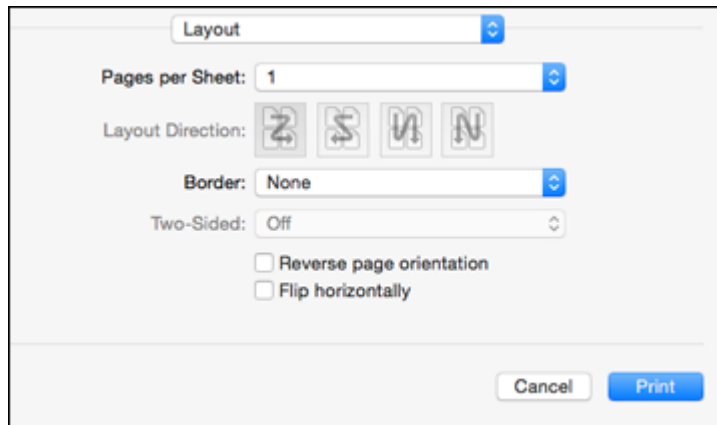

- To print multiple pages on one sheet of paper, select the number of pages in the **Pages per Sheet** pop-up menu. To arrange the print order of the pages, select a **Layout Direction** setting.
- To print borders around each page on the sheet, select a line setting from the **Border** pop-up menu.
- To invert or flip the printed image, select the **Reverse page orientation** or **Flip horizontally** settings.

Parent topic: [Printing on a Mac](#)

Selecting Advanced Settings - Mac

You can select roll paper settings and adjust color density from the Advanced menu.

1. Select **Advanced** from the dropdown menu.

You see this window:

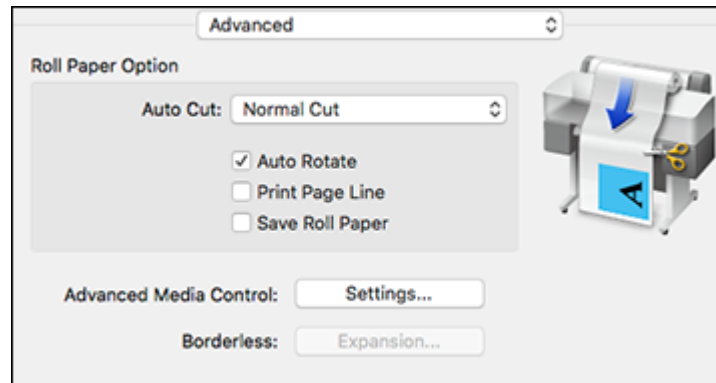

Note: Some settings may not be available, depending on the selected paper source and the Roll Paper option you selected for your paper size.

2. Select one of the following **Auto Cut** settings:

- **Off:** Select this option to cut your prints manually.
- **Normal Cut:** Creates a margin at the top and bottom of your image and automatically cuts the paper. These margins vary by media type and may be changed from their defaults using custom media settings.

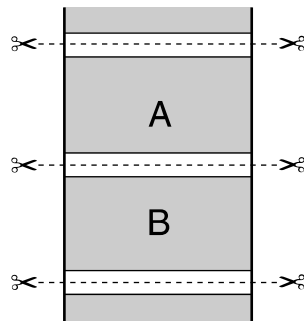

- **Single Cut:** Prints images end-to-end with no gap between them. Borderless images may overlap slightly.

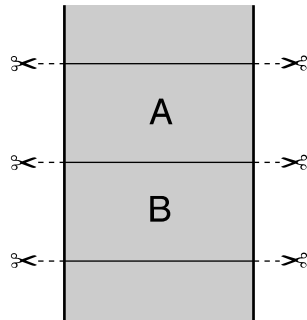

- **Double Cut:** Increases the space between each image and trims each print individually, providing the cleanest edge for borderless printing.

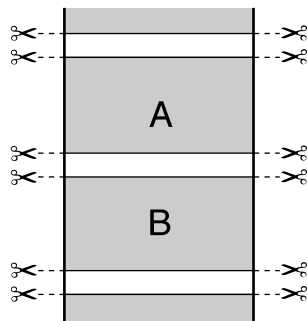

3. Select the following settings as necessary:
 - Select the **Auto Rotate** checkbox to automatically position the image or print data to fit the roll paper.
 - Select the **Print Page Line** checkbox to print lines between pages as a guide for manual cutting.
 - When **Auto Cut** is enabled, select the **Save Roll Paper** checkbox to have the printer cut the roll paper at the end of the image as positioned on the page.

4. If you want to adjust color density, click **Settings**, adjust the **Black** and **Color** settings, and click **OK**.

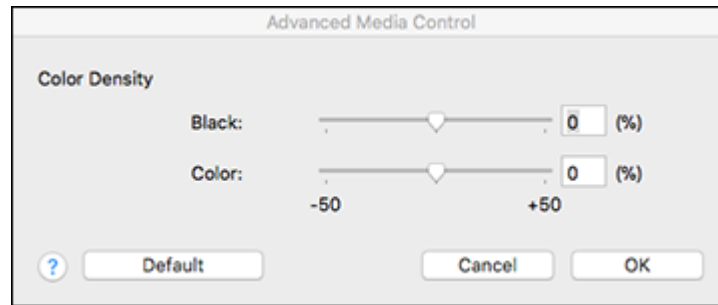

5. Select **Expansion** to adjust the amount of image expansion when printing borderless images.

Note: This option is available only when you choose a **Paper Size** setting with a **Borderless** option.

Parent topic: [Printing on a Mac](#)

Managing Color - Mac

You can adjust the Color Matching settings to fine-tune the colors in your printout, or turn off color management in your printer software.

1. Select **Color Matching** from the pop-up menu in the print window.

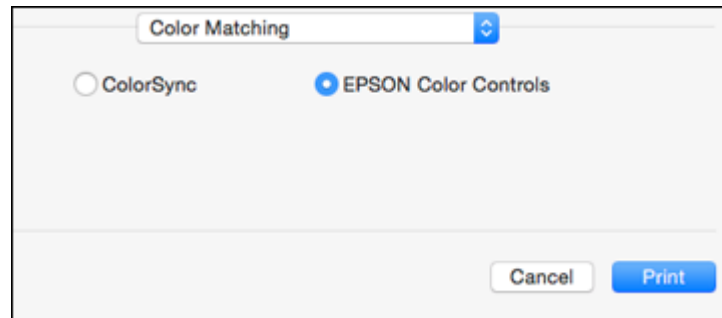

2. Select one of the available options.

[Color Matching Options - Mac](#)

Parent topic: [Printing on a Mac](#)

Color Matching Options - Mac

You can select from these settings on the **Color Matching** menu.

ColorSync

Prints using standard color profiles for your product and paper to help match image colors.

EPSON Color Controls

Lets you manage color using controls in your printer software or turn off color management.

Parent topic: [Managing Color - Mac](#)

Sizing Printed Images - Mac

You can adjust the size of the image as you print it by selecting **Paper Handling** from the pop-up menu on the Print window.

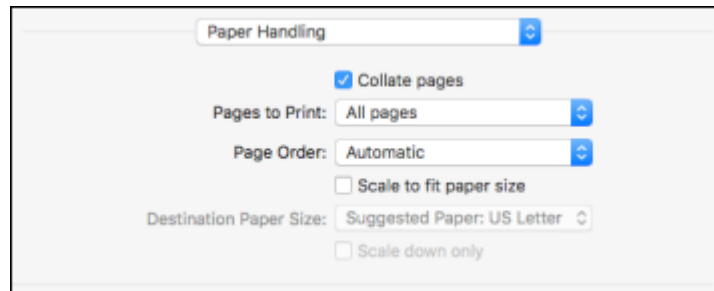

- To collate multiple copies into sets of documents, select the **Collate pages** checkbox.
- To print only selected pages in a multi-page document, select an option from the **Pages to Print** pop-up menu.
- To adjust the order in which pages are printed, select an option from the **Page Order** pop-up menu.
- To scale the image to fit on a specific paper size, select the **Scale to fit paper size** checkbox and select a paper size from the **Destination Paper Size** pop-up menu.
- To restrict scaling of the image to reduced sizing, select the **Scale down only** checkbox. (Deselect this checkbox when enlarging the image.)

Parent topic: [Printing on a Mac](#)

Selecting Printing Preferences - Mac

You can select printing preferences that apply to all the print jobs you send to your product.

1. In the Apple menu or the Dock, select **System Preferences**.
2. Select **Print & Fax**, **Print & Scan**, or **Printers & Scanners**, select your product, and select **Options & Supplies**.
3. Select **Options**.

You see a screen like this:

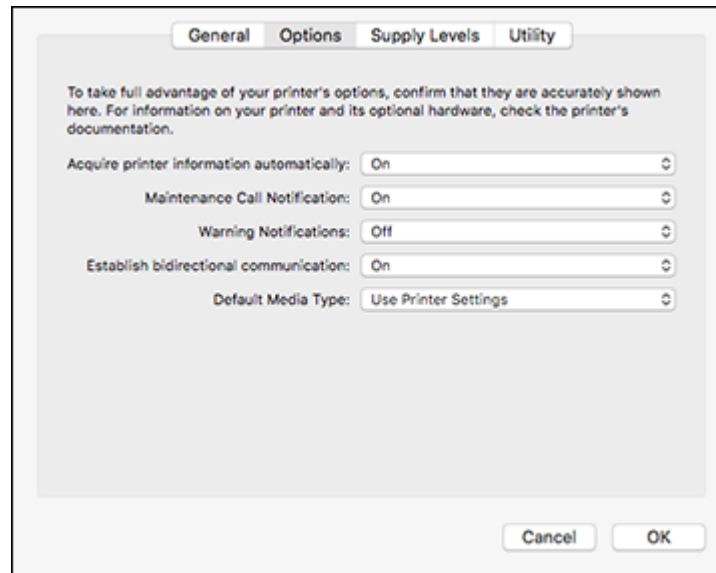

4. Select any of the available printing options.
5. Click **OK**.

[Printing Preferences - Mac](#)

Parent topic: [Printing on a Mac](#)

Printing Preferences - Mac

You can select from these settings on the **Options** tab.

Acquire printer information automatically

Ensures that the paper size and paper type settings are automatically updated if paper is loaded or changed after closing the print window.

Maintenance Call Notification

Alerts you if the maintenance box is nearing capacity or needs to be replaced.

Warning Notifications

Lets you choose whether or not to receive warning notifications from the printer software for various operating conditions.

Establish bidirectional communication

Allows the product to communicate with the computer. Do not change the default setting unless you experience issues when using a shared printing pool.

Default media type

Select the Media Type that you want to use as the default in the printer driver.

Parent topic: [Selecting Printing Preferences - Mac](#)

Printing Your Document - Mac

Once you have selected your print settings, you are ready to print.

Click **Print** at the bottom of the print window.

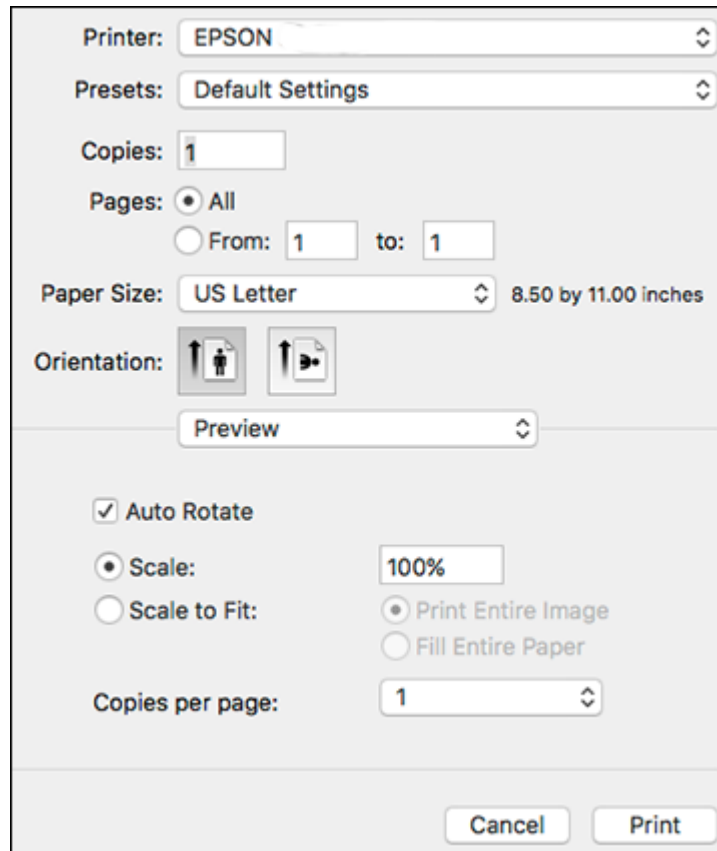

[Checking Print Status - Mac](#)

Parent topic: [Printing on a Mac](#)

Checking Print Status - Mac



During printing, you can view the progress of your print job, control printing, and check ink status.

1. Click the printer icon when it appears in the Dock.

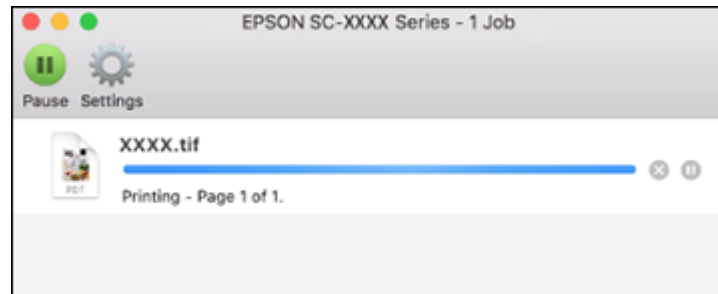
You see the print status window:



2. Select the following options as necessary for your Mac OS version:

- To cancel printing, click the print job and click  or **Delete**.
- To pause a print job, click the print job and click  or **Hold**. To resume a print job, click the paused print job and click  or **Resume**.
- To pause printing for all queued print jobs, click **Pause** or **Pause Printer**.
- To display other printer information, click **Settings** or **Supply Levels**.

Parent topic: [Printing Your Document - Mac](#)

Printing CAD Drawings

Your product can print CAD drawings from CAD software applications. You can print them from the printer driver or change settings in the product to emulate HP-GL/2 or HP RTL modes.

Note: Not all HP-GL/2 and HP RTL features are supported on the product.

[Printing CAD Drawings from the Printer Driver](#)

[Printing CAD Drawings in HP-GL/2 or HP RTL Mode](#)

Parent topic: [Printing from a Computer](#)

Printing CAD Drawings from the Printer Driver

You can print CAD drawings using your printer driver. This printing method is best for high quality views and drawings.

Note: If lines in your drawing are not printed properly, print the drawing using HP-GL/2 or HP RTL mode using the product control panel.

1. Open the file you want to print in your CAD software.
2. Click **Plot** and select your product as the printer.
3. Click **Properties**.
4. On the **Device and Document Settings** tab, click **Custom Properties**.

You see the printer driver window:

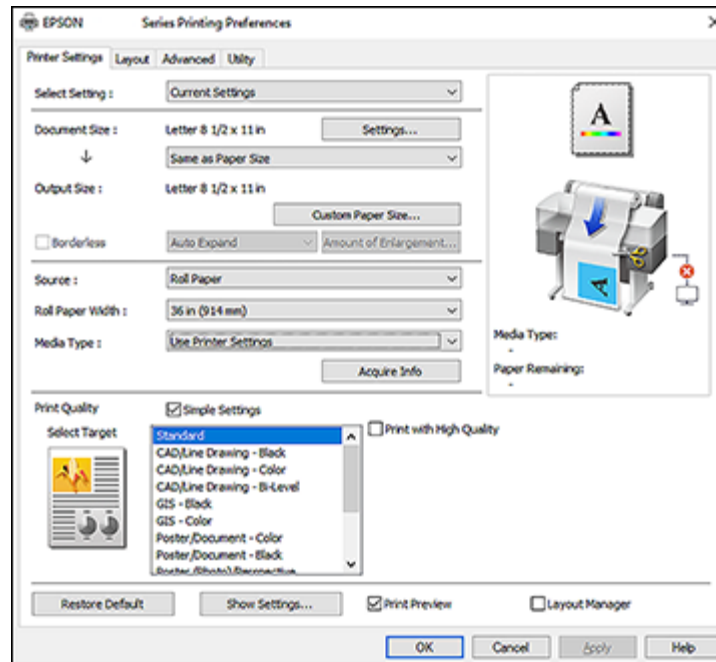

5. Select the **Document Size** and **Output Size** settings as necessary.
6. Select the **Source** setting.

Note: If you select **Roll Paper**, select the width of the roll as the **Roll Paper Width** setting.

7. Select the **Media Type** setting.

8. Choose one of the CAD/Line Drawing options as the **Select Target** setting.
9. Select any other printing settings as necessary and click **OK**.
10. Start printing your drawing from the CAD software.

Parent topic: [Printing CAD Drawings](#)

Printing CAD Drawings in HP-GL/2 or HP RTL Mode

You can change settings on your product's control panel to print CAD drawings using HP-GL/2 or HP RTL mode. This printing method is best for maps and blueprints, or when lines need to be emphasized.

Note: Not all HP-GL/2 and HP RTL features are supported on the product.

1. Press the  home button on your product, if necessary.
2. On the LCD screen, select **Settings** > **General Settings** > **Printer Settings** > **Universal Print Settings**.

You see this screen:



3. Make sure the **Paper Source** setting is set to **Roll Paper**.

Note: If roll paper is not selected when HP-GL2 or HP RTL print data is sent, an error occurs.

4. Select any other settings as necessary.
5. Select the left arrow to return to the previous screen.

6. Select **HP-GL/2 Unique Settings**.

You see this screen:



7. Change the settings as necessary.
8. Select the left arrow to return to the previous screen.
9. Select **Printing Language**.
 - If you are printing over USB, select **USB** and change the **Printing Language** setting to **HP-GL/2**.
 - If you are printing over a network, select **Network** and change the **Printing Language** setting to **HP-GL/2**.

Note: Make sure you return the **Printing Language** setting to **Auto** when you are done printing in HP-GL/2 mode.

10. Open the file you want to print in your CAD software.
11. Click **Plot** and select your product as the printer.
12. Start printing your drawing from the CAD software.

Parent topic: [Printing CAD Drawings](#)

Printing from a USB Memory Device

You can save JPG or TIFF images on a USB memory device and then connect the device to the printer for printing.

Note: USB memory devices with security settings (such as password protection) are not supported.

[USB Memory Device Requirements](#)

[Connecting and Printing from a USB Memory Device](#)

USB Memory Device Requirements

Make sure your USB memory device meets these requirements.

Note: Connections that use an extension cable, a USB hub, or a card reader cannot be guaranteed.

- Format type: FAT32, FAT16, or exFAT
- No security functions such as encryption or passwords

Parent topic: [Printing from a USB Memory Device](#)

Connecting and Printing from a USB Memory Device

You can print from a USB memory device connected to your printer.

1. Connect the USB memory device containing the saved data to the USB memory device port on the control panel.

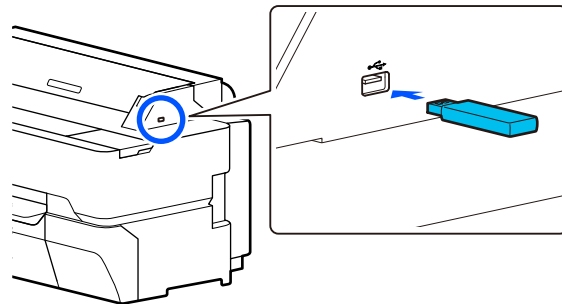

2. Press the  home button, if necessary.
3. Select **Memory Device**.
4. Select **JPEG** to display a list of thumbnails or **TIFF** to display a list of files.
5. Do one of the following to select a single image to print:
 - **JPEG**: Select an image and select **Proceed to Print**. Select **Single View** to view each image individually.
 - **TIFF**: Select the file name.

You see a screen like this:

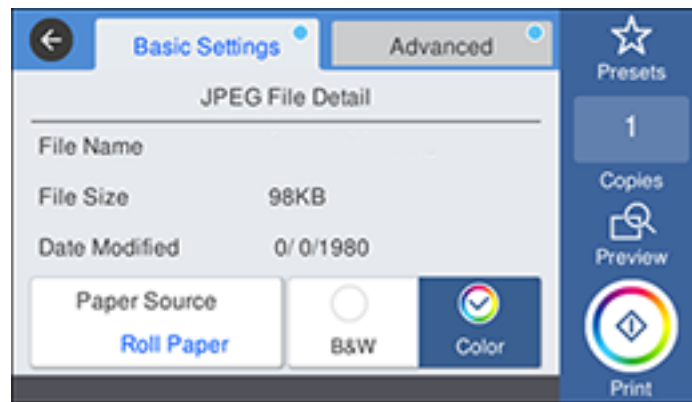

6. Select the paper source and either **Black/White** or **Color**.
7. Select the **Advanced** tab and select any necessary settings.

Note: You can select **Presets** to use a previously saved group of settings.
8. Select the number of copies and use the on-screen keyboard to enter the amount, if necessary.
9. Select **Print** to begin printing.

[Memory Device Settings Menu](#)

Parent topic: [Printing from a USB Memory Device](#)

Memory Device Settings Menu

Basic Settings

Setting	Options	Description
Copies	1 to 99	Specifies the number of copies to print
Paper Source	Roll Paper Cut Sheet (1 sheet)	Selects the paper source.
Color Mode	Black/White Color	Selects the color mode to use when printing

Advanced

Setting	Options	Description
Quality	Speed Fine Super Fine	Specifies the print quality
Page Margins option	Clip By Margins	Adds the value selected for the page margin inside the size selected for the base output size
	Oversize	Adds the value selected for the page margin outside the size selected for the base output size (when set to a standard size)
	Borderless	Enlarges the print size slightly to print a borderless image on roll paper
Bidirectional	On Off	Select On to print in both directions, resulting in faster print speed but reduced accuracy

Setting	Options	Description
Color Mode	EPSON Standard (sRGB)	Optimizes the sRGB space and corrects the color
	Business Graphics	Performs color correction to optimize your images based on the sRGB space
	GIS	Performs color correction when printing topographical maps
	Line Drawing	Perform color correction when printing CAD drawings and other line drawings
	Off (No Color Management)	Turns off color management in the printer
Reduce/Enlarge	Auto Fit Page	Select On to fit the short edge of the image to the width of the paper Note: This setting is not available if paper is not loaded into the printer.
	Custom Size	Select Actual Size to print using the image size or select a different output size

Parent topic: [Connecting and Printing from a USB Memory Device](#)

Using Your Printer as a Copier

You can connect a supported Epson scanner to your printer and print out enlarged scans on roll paper.

The following Epson scanners are supported:

- DS-530
- DS-7500
- DS-70000

Note: Visit the Epson website for the most updated list of supported scanners.

[Connecting a Scanner to Your Printer](#)

[Placing Originals in the Scanner](#)

[Printing Enlarged Copies from the Scanner](#)

Connecting a Scanner to Your Printer

You can connect a supported scanner directly to the printer to print out enlarged copies.

1. Turn off the printer and the scanner.

2. Connect one end of the USB cable supplied with the scanner to the scanner port and the other end to the **OPTION** port on the back of the printer.

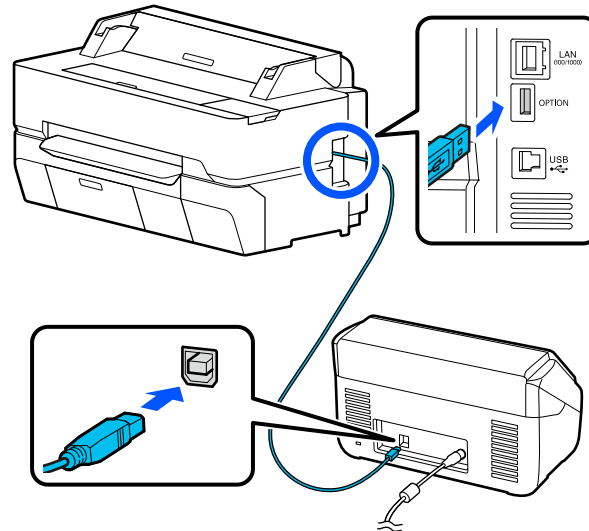

Parent topic: [Using Your Printer as a Copier](#)

Placing Originals in the Scanner

See your scanner's *User's Guide* for instructions on placing originals in the scanner.

Follow these guidelines to prevent reduced print quality or other scanning problems:

- You can copy only one side of a double-sided document at a time, even if your scanner supports double-sided scanning. Place the side you want copied facedown on the scanner glass or in the automatic document feeder (ADF).
- Make sure there are no originals in the ADF if you want to scan an original from the scanner glass.
- Use the ADF to scan multi-page originals.
- Do not use the ADF if the original is printed on thick paper or cardstock.
- Do not use the ADF if **JIS B1** or **A0** is selected as the **Reduce/Enlarge** setting.
- If you make multiple copies from an original placed on the scanner glass, the original is scanned for each copy. Make sure all copies have finished printing before opening the scanner cover.

Parent topic: [Using Your Printer as a Copier](#)

Printing Enlarged Copies from the Scanner

After the scanner and printer are connected and originals are placed in the scanner, you can print enlarged copies from the printer.

1. Turn on the printer and the scanner.

The **Enlarged Copy** option appears on the LCD screen:

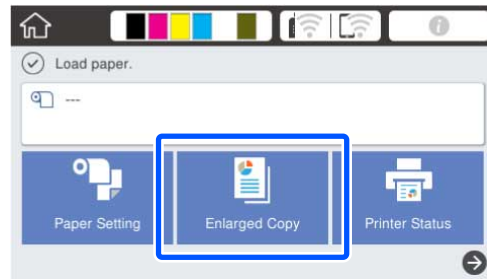

Note: If you do not see the **Enlarged Copy** option, make sure the cables connecting the printer and scanner are secure and the scanner is turned on.

2. Make sure roll paper is loaded in the printer.

Note: Only roll paper is supported for enlarged copies.

3. Select **Enlarged Copy**.

You see a screen like this:



4. Select the size of your original as the **Original Size** setting.
5. Select a **Reduce/Enlarge** option to set the output size.

Note: If you select **Auto Fit Page**, the copy is enlarged to fit the width of the roll paper.

6. Select any other settings as necessary.
7. Select the number of copies as the **Copies** setting.
8. Select **Copy** on the printer LCD screen or press the scan button on the scanner to begin copying.

[Supported Copy Sizes](#)

Parent topic: [Using Your Printer as a Copier](#)

Supported Copy Sizes

The following original and output sizes are supported for enlarged copies:

Type	Size
Original size	5 × 7 inches (127 × 178 mm) A3 (11.7 × 16.5 inches [297 × 420 mm]) A4 (8.3 × 11.7 inches [210 × 297 mm]) A5 (5.8 × 8.2 inches [148 × 210 mm]) B4 (13.9 × 9.84 inches [353 × 250 mm]) B5 (7.2 × 10.1 inches [182 × 257 mm]) Letter (8.5 × 11 inches [216 × 279 mm])
Output size	A0 (33.1 × 44 inches [841 × 1189 mm])* A1 (23.4 × 33.1 inches [594 × 841 mm]) A2 (16.5 × 23.4 inches [420 × 594 mm]) B1 (27.8 × 39.4 inches [707 × 1000 mm])* B2 (19.7 × 27.8 inches [500 × 707 mm]) 17 × 22 inches (432 × 559 mm) 22 × 34 inches (559 × 864 mm) 34 × 44 inches (864 × 1120 mm)*

Note: The available original sizes depend on the scanner you are using.

*Not supported on the SureColor T3475

Parent topic: [Printing Enlarged Copies from the Scanner](#)

Using the Control Panel Menus

Follow the instructions in these sections to access the printer menu system and select settings.

[Accessing the Printer's Menus](#)

[Paper Setting Menu](#)

[Basic Settings Menu](#)

[Printer Settings Menu](#)

[Network Settings Menu](#)

[System Administrator Settings Menu](#)

[Maintenance Menu](#)

[Printer Status/Print Menu](#)

Accessing the Printer's Menus

You can use the printer menus to adjust the settings that control how your printer works.

1. Press the  home button, if necessary.
2. Select **Settings** on the LCD screen.

You see this screen:



3. Press the up or down arrow to scroll through the menus, or swipe up or down on the LCD screen.

Note: To return to the previous screen, press the left arrow button.

4. Press the up or down arrow to move through the settings, or swipe up or down on the LCD screen.
5. To select a setting, select **OK** any time the **OK** option is displayed. You can also select a setting to toggle it on or off.
6. When you finish changing settings on a menu, press the left arrow button to go back or press the  home button to completely exit the menu.

Parent topic: [Using the Control Panel Menus](#)

Paper Setting Menu

Select **Paper Setting** to customize paper options.

Roll Paper menu

Setting	Options	Description
Remove	—	Rewinds the loaded roll paper until it is ejected from the paper feeder
Feed/Cut Paper	Backward Forward Cut	Moves the paper backward or forward, or cuts it using the built-in cutter

Setting	Options	Description
Media Adjust	Easy Adjustment	Select Start to automatically run the paper feed adjustment and print head alignment
	Paper Feed Adjust	Select Auto to automatically adjust the paper feed Select Manual if an error appears during automatic adjustment or if you are not satisfied with the results of the automatic adjustment Select Print length adjustment to precisely adjust the paper feed amount Note: You will need a ruler to perform print length adjustment.
	Print Head Alignment	Select Auto to automatically align the print head Select Manual if an error appears during automatic alignment or if you are not satisfied with the results of the automatic alignment
Advanced Media Setting	Various options	See the Advanced Media Setting table below
Manage Remaining Amount	Setup	Select On to display and record the amount of remaining roll paper
	Remaining Amount	Enter the total length of paper currently on the roll (16.4 to 492 feet [5 to 150 m])
	Remaining Alert	Select the amount of remaining roll paper before a warning is displayed (3.3 to 49.2 feet [1 to 15 m])
Change Paper Type	Paper Type	Select Plain Paper , Coated Paper (Generic) , or Premium Glossy Sheet . Select Others to choose another paper type.
	Paper Type	Select the width of the loaded paper, or User-Defined if the width is not listed

Advanced Media Setting menu (in the **Roll Paper** menu)

Setting	Options	Description
Platen Gap	1.2 1.6 2.1	Adjusts the distance between the print head and the paper; displayed when Custom Paper is selected as the Paper Type setting
Top/Bottom Margins	Standard Top 3 mm/Bottom 3 mm Top 15 mm/Bottom 15 mm Top 35 mm/Bottom 15 mm	The Standard margins are as follows for the top and bottom: <ul style="list-style-type: none"> • CAD/line drawings: 3 mm • Other: 30 mm Select a different value as necessary. Note: Left and right margins are always 3 mm.
Paper Suction	-4 to +3	Select this to adjust the distance between the paper and the print head. Choose lower values for thinner papers.
Back Tension	Auto Standard High Extra High	Select High or Extra High if paper wrinkles during printing Note: If the paper still wrinkles when you select High , select Extra High and then change the level of suction by adjusting the Settings > General Settings > Printer Settings > Paper Source Settings > Roll Paper Setup > Back Tension 2 setting.
Drying Time	Drying Time per Pass	Select from 0 to 10 seconds for the amount of time the print head pauses to allow drying after each pass
	Drying Time per Page	Select from 0 to 60 minutes for the amount of time the printer pauses to allow drying after each page is printed

Setting	Options	Description
Paper Size Check	On Off	Select On to detect the paper width when paper is loaded. Select Off if a paper setting error occurs when paper is correctly loaded. Note: If this setting is set to Off , the printer may print beyond the edges of the paper, causing ink to get on the printer.

Cut Sheet (1 sheet) menu

Setting	Options	Description
Remove	—	Ejects the loaded cut sheet
Media Adjust	Easy Adjustment	Select Start to automatically run the paper feed adjustment and print head alignment
	Paper Feed Adjust	Select Auto to automatically adjust the paper feed Select Manual if an error appears during automatic adjustment or if you are not satisfied with the results of the automatic adjustment
	Print Head Alignment	Select Auto to automatically align the print head Select Manual if an error appears during automatic alignment or if you are not satisfied with the results of the automatic alignment
Change Paper Type/Paper Size	Paper Type	Select Plain Paper , Coated Paper (Generic) , or Premium Glossy Sheet . Select Others to choose another paper type.
	Paper Size	Select a paper size or select User-Defined if your desired size is not listed

Advanced Media Setting menu (in the Cut Sheet (1 sheet) menu)

Setting	Options	Description
Platen Gap	1.2 1.6 2.1	Adjusts the distance between the print head and the paper; displayed when Custom Paper is selected as the Paper Type setting
Paper Suction	-4 to +3	Select this to adjust the distance between the paper and the print head. Choose lower values for thinner papers.
Paper Size Check	On Off	Select On to detect the paper width when paper is loaded; displayed when Custom Paper is selected as the Paper Type setting . Select Off if a paper setting error occurs when paper is correctly loaded. Note: If this setting is set to Off , the printer may print beyond the edges of the paper, causing ink to get on the printer.
Auto Cut	On Off	Select On to automatically cut roll paper after each page is printed, or select Off to cut paper manually
Remove Skew	On Off	Select On to enable paper skew reduction

Parent topic: [Using the Control Panel Menus](#)

Related tasks

[Loading Roll Paper](#)

[Creating Custom Paper Configurations](#)

[Selecting the Paper Settings for Each Source - Control Panel](#)

Related topics

[Cutting Roll Paper](#)

Basic Settings Menu

Select **Settings** > **General Settings** > **Basic Settings** to customize various display and power settings.

Setting	Options	Description
LCD Brightness	1 to 9	Adjusts LCD screen brightness
Sound	Mute	Select On to mute control panel sounds
	Normal Mode	Button Press: Adjusts the volume of control panel sounds Error Notice: Adjusts the volume of error notifications Sound Type: Adjusts the type of control panel sounds
Sleep Timer	1 to 60 minutes	Selects the amount of time until the printer enters sleep mode
Power Off Timer	Various times Off	Selects the amount of time until the printer turns off automatically
Circuit Breaker Interlock Startup	On Off	Selects whether to turn the printer on or off when the circuit breaker switch is turned on
Date/Time Settings	Date/Time	Enters the date and time
	Time Difference	Sets the time difference for coordinated universal time (UTC)
Language	Various languages	Selects the language used on the LCD screen
Operation Time Out	On Off	Select On to return to the Home screen after a few minutes of inactivity
Keyboard	Various settings	Selects the keyboard arrangement for text input screens
Length Unit	m ft/in	Selects the unit of length displayed on the LCD screen

Parent topic: [Using the Control Panel Menus](#)

Related tasks

[Changing the LCD Screen Language](#)

[Selecting the Date and Time](#)

Printer Settings Menu

Select **Settings > General Settings > Printer Settings** to customize paper and printing options.

Setting	Options	Description
Paper Source Settings	Various options	See the Paper Source Settings table below
Custom Paper Settings	1 to 10	See the Custom Paper Settings table below
Printing Language*	USB Network	Select the printing language to use for each connection mode Auto : select for most printing situations HP-GL/2 : select if HP-GL/2 or HP RTL print data sent from a CAD application does not automatically switch the printing mode
Universal Print Settings*	Various options	See the Universal Print Settings table below
HP-GL/2 Unique Settings*	Various options	See the HP-GL/2 Unique Settings table below
Memory Device Interface	Enable Disable	Select Disable to prevent printing directly from a USB device
Thick Paper	On Off	Select On to widen the platen gap to prevent scuffing if you are printing on thick paper
Self Check and Cleaning	Off Once Twice Three times	Select the number of times to automatically perform a print head check and cleaning when the printer turns on and before printing; selecting Off prevents the print head check and the automatic cleaning
Bidirectional	On Off	Select On if you want the print head to move left and right during printing Select Off to decrease misalignment of ruled lines, but slow down printing

Setting	Options	Description
PC Connection via USB	Enable Disable	Select Enable to allow access to the printer from a USB-connected computer
USB I/F Timeout Setting	5 to 300 seconds	Specifies the length of time before ending communication from a USB-connected computer

*The **Printing Language**, **Universal Print Settings**, and **HP-GL/2 Unique Settings** menus can be locked by an administrator. If you cannot access or change these settings, contact your administrator for assistance.

Paper Source Settings

Setting	Options	Description
Error Notice	Paper Size Notice Paper Type Notice	Select On to display an error message when the output size or paper type settings are different between the driver and printer
Roll Paper Setup	Detect Paper Meandering	Select On to display an error message and stop printing if the printer detects the paper is skewed
	Print Cutting Guideline	Select On to print cut lines on roll paper (if Auto Cut is turned off)
	Cut for Borderless Print	Select Two Cuts to insert a margin and cut twice between pages; or One Cut to cut once between pages
	Quick Cut	Select On to cut once between pages while the next page is still printing
	Cut Mode	Select Quiet to reduce the speed and noise when cutting paper
	Margin Refresh	Select On to automatically remove ink stains from previous borderless prints by trimming the leading edge of the paper
	Back Tension 2	Select the level of tension when the Back Tension setting is set to Extra High

Custom Paper Setting

Setting	Options	Description
Change Name	—	Use the keyboard to enter a name for the custom paper setting (this name is displayed in the Paper Type list)
Change Reference Paper	Various options	Select the media type for the paper closest to the one you are using
Advanced Media Setting options		
	Platen Gap	Select a larger value if print results are smudged by print head strikes
	Top/Bottom Margins	The Standard margins are as follows for the top and bottom: <ul style="list-style-type: none"> • CAD/line drawings: 3 mm • Other: 30 mm Select a different value as necessary. Left and right margins are always 3 mm.
	Paper Suction	Select this to adjust the distance between the paper and the print head; lower values for thinner papers.
	Back Tension	Select High or Extra High if paper wrinkles during printing
	Drying Time	Drying Time per Pass: Select from 0 to 10 seconds for the amount of time the print head pauses to allow drying after each pass Drying Time per Page: Select from 0 to 60 minutes for the amount of time the printer pauses to allow drying after each page is printed

Setting	Options	Description
	Paper Size Check	Select On to detect the paper width when paper is loaded Select Off if a paper setting error occurs when paper is correctly loaded. If this setting is set to Off , the printer may print beyond the edges of the paper, causing ink to get on the printer.
	Auto Cut	Select On to automatically cut roll paper after each page is printed, or select Off to cut paper manually
	Remove Skew	Select On to enable paper skew reduction
Restore Default	—	Restores the custom setting to the defaults

Universal Print Settings

Adjust these settings as necessary when printing in HP-GL/2 or HP RTL mode, or when using AirPrint.

Setting	Options	Description
Paper Source	Roll Paper Cut Sheet (1 sheet)	Select the paper source from which you want to print
Quality	Standard Speed Fine Super Fine Draft	Select the print quality
Color Mode	Color Black/White	Select the color you want for printing

Setting	Options	Description
Page Margins option	Clip By Margins	Adds the value selected for the page margin inside the hard clip area of the PS command of the data, or the size selected for the base output size
	Oversize	Adds the value selected for the page margin outside the hard clip area of the PS command of the data (when Auto is selected) Adds the value selected for the page margin outside the size selected for the base output size (when set to a standard size)
Page Margin	3 mm 5 mm	Select the top, bottom, left, and right margin values for roll paper Note: Margins are 3 mm for cut sheets regardless of the setting.
Smoothing	On Off	Select On to print at the maximum resolution for the selected paper type Note: This may result in longer printing time or insufficient memory errors.
Base Output Size	Various options	When Auto (the default setting) is selected, the hard clip area of the PS command of the data becomes the base output size Select User-Defined when printing in a custom size
Resolution	Standard 300 dpi 600 dpi 1200 dpi	Selects the print resolution; when Standard (the default setting) is selected, available resolutions depend on the selected paper type

Setting	Options	Description
Color Mode (Common)	EPSON Standard (sRGB)	Optimize the sRGB space and correct the color
	Business Graphics	Perform color correction to optimize your images based on the sRGB space
	GIS	Perform color correction when printing topographical maps
	Line Drawing	Perform color correction when printing CAD drawings and other line drawings
	Off (No Color Management)	No color correction is performed

HP-GL/2 Unique Settings

Adjust these settings as necessary when printing in HP-GL/2 or HP RTL mode.

Setting	Options	Description
Rotate	0° 90° 180° 270°	Rotate the coordinates of the drawn data counterclockwise before printing
Origin Setup	Left Edge Center	Set the data coordinate origin
Mirror Image	On	Select to horizontally flip the image using the center of the output size width as the basis line
	Off	Select to print without flipping the image
Line Merge	On	Select to merge the intersection of overlapping lines within the image according to the MC command of the data
	Off	Select to move lines to be printed later to the front at intersections

Setting	Options	Description
Color Mode (HP-GL/2)	EPSON Standard (sRGB)	Optimize the sRGB space and correct the color
	Business Graphics	Perform color correction to optimize your images based on the sRGB space
	GIS	Perform color correction when printing topographical maps
	Line Drawing	Perform color correction when printing CAD drawings and other line drawings
	Off (No Color Management)	No color correction is performed
Select Palette	Software	Print according to the pen configurations set in the application and ignore the built-in printer palette
	Default	Print according to the built-in printer palette settings (logical pen with a pen width of 0.35 mm and 256 colors)
	Palette A Palette B	Print according to the built-in printer palette settings specified under Define Palette
Print Color Palette	Print	Select to print the selected palette in A3 size
Define Palette	Palette A Palette B	Define a built-in palette by specifying the pen width and color for the 16 types of logical pens
Restore Default HP-GL/2 Unique Settings	No Yes	Select Yes to restore all HP-GL/2 Unique Settings to their defaults

Parent topic: [Using the Control Panel Menus](#)

Related tasks

[Printing CAD Drawings in HP-GL/2 or HP RTL Mode](#)

[Creating Custom Paper Configurations](#)

[Selecting the Paper Settings for Each Source - Control Panel](#)

Network Settings Menu

Select **Settings > General Settings > Network Settings** to configure your printer's network settings.

Setting	Options	Description
Wi-Fi Setup	Router Wi-Fi Direct	See the link below for more information
Wired LAN Setup	—	See the link below for more information
Network Status	Wired LAN/Wi-Fi Status	Displays current communication status and connection settings
	Wi-Fi Direct Status	Displays the number of connected devices and connection settings
	Print Status Sheet	Prints the current network connection information
Connection Check	—	Confirms the network status. You can also print a connection check report.
Advanced	—	Displays advanced information, such as TCP/IP settings. You can enable or disable other network settings.

Parent topic: [Using the Control Panel Menus](#)

Related tasks

[Selecting Wireless Network Settings from the Control Panel](#)

[Enabling Wi-Fi Direct Mode](#)

System Administrator Settings Menu

Select **Settings > General Settings > System Administrator Settings** to configure security settings and update firmware.

Setting	Options	Description
Security Settings	Admin Settings	Lets you add or change the administrator password If you choose to add a password, set the Lock Setting to On to enable password entry for certain features and settings.
Restore Default Settings	Network Settings	Select Yes to restore all network settings to their defaults
	Clear All Data and Settings	Select Yes to restore all settings to their defaults (except date/time, length unit, and language settings)
Firmware Update	Update	Select Start Checking to access the Epson website and search for a firmware update. The printer must be connected to the internet. Follow the prompts to update the firmware, which can take up to 5 minutes or longer. Note: Do not turn off or unplug the printer during a firmware update or you may damage the printer.
	Notification	Select On to allow the printer to automatically check for new firmware; a message is displayed on the LCD screen if new firmware is found

Parent topic: [Using the Control Panel Menus](#)

Related tasks

[Setting a Password and Locking the Control Panel](#)

Maintenance Menu

Select **Settings** > **Maintenance** to run nozzle checks, cleaning cycles, and other maintenance operations.

Caution: Follow the instructions in the topic links below the table to use these menu settings correctly.

Setting	Description
Print Quality Adjustment	Perform when there are streaks in printouts, ruled lines are duplicated, or text is blurred
Print Head Nozzle Check	Prints a nozzle check pattern so you can check for clogged nozzles
Head Cleaning	Perform if the nozzle check pattern has faint or missing areas
Ink Cartridge(s) Replacement	Moves the print head to the correct position so you can replace ink cartridges. Displays the ink cartridge replacement procedure.
Replace Maintenance Box	Displays the maintenance box replacement procedure
Replace Cutter	Displays the cutter replacement procedure
Powerful Cleaning*	Perform if the nozzle check pattern still has faint or missing areas after performing a head cleaning three times in a row
Discharging/Charging Ink*	Perform if you are transporting or storing the printer in 14°F (–10°C) or lower temperatures. Follow the prompts to eject the ink. The printer turns off automatically after the procedure.

*The **Powerful Cleaning** and **Discharging/Charging Ink** settings can be locked by an administrator. If you cannot access or change these settings, contact your administrator for assistance.

Parent topic: [Using the Control Panel Menus](#)

Related tasks

[Checking the Nozzles Using the Product Control Panel](#)

[Cleaning the Print Head Using the Product Control Panel](#)

[Replacing the Cutter](#)

[Replacing the Borderless Pads](#)

[Discharging Ink](#)

[Removing and Installing Ink Cartridges](#)

[Replacing the Maintenance Box](#)
[Using the Powerful Cleaning Utility](#)

Printer Status/Print Menu

Select **Settings > Printer Status/Print** to view current printer and network settings.

Setting	Options	Description
Print Status Sheet	Configuration Status Sheet	Prints a summary of current printer settings
Network	Wired LAN/Wi-Fi Status	Displays current communication status and connection settings
	Wi-Fi Direct Status	Displays the number of connected devices and connection settings
	Print Status Sheet	Prints the current network connection information

Parent topic: [Using the Control Panel Menus](#)

Replacing Ink Cartridges and Maintenance Boxes

If a message appears or the  icon appears above an ink color on the LCD screen, the cartridge is low or expended. When an ink cartridge is expended, printing stops and you need to replace the cartridge. You may also need to replace a cartridge that is more than six months old, or if your printouts do not look their best, even after cleaning and aligning the print head.

The maintenance box stores ink that gets flushed from the system during print head cleaning. If a message appears or the  icon appears above the maintenance box icon on the LCD screen, the amount of available space in the maintenance box is low. When the maintenance box is full, you need to replace it.

Note: Please dispose of your used Epson branded ink cartridges responsibly and in accordance with local requirements. If you would like to return your used ink cartridges to Epson for proper disposal, please go to [epson.com/recycle](https://www.epson.com/recycle) for more information.

- [Check Cartridge and Maintenance Box Status](#)
- [Purchase Epson Ink Cartridges and Maintenance Box](#)
- [Removing and Installing Ink Cartridges](#)
- [Replacing the Maintenance Box](#)

Check Cartridge and Maintenance Box Status

Your product and its software will let you know when an ink cartridge is low or expended, or when the maintenance box needs to be replaced.

- [Checking Ink Cartridge and Maintenance Box Status on the LCD Screen](#)
- [Checking Ink Cartridge and Maintenance Box Status with Windows](#)
- [Checking Cartridge and Maintenance Box Status - Mac](#)

Parent topic: [Replacing Ink Cartridges and Maintenance Boxes](#)

Checking Ink Cartridge and Maintenance Box Status on the LCD Screen

When one of your ink cartridges is low or expended, or the maintenance box is almost full, you see a message on the LCD screen.

You can also check the status of the ink cartridges and maintenance box from the product control panel. If the  icon appears on an ink color or the maintenance box, you need to replace them soon.

1. Press the  home button, if necessary.

2. Do one of the following:
 - Select the ink color icons at the top of the home screen.
 - Select **Printer Status > Supply Status**.

You see a screen like this:

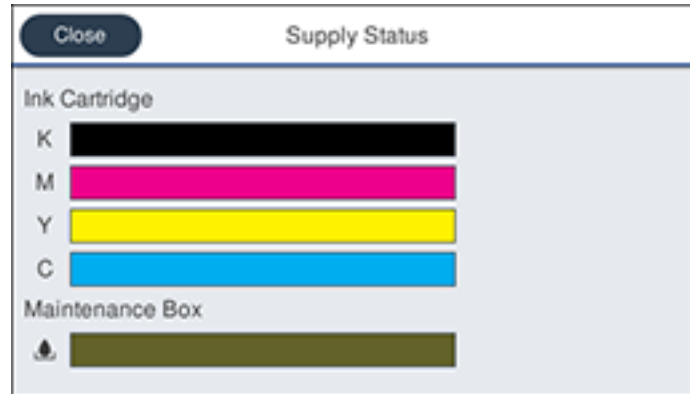

Note: The displayed ink and maintenance box levels are approximate.

Parent topic: [Check Cartridge and Maintenance Box Status](#)



Related tasks

[Removing and Installing Ink Cartridges](#)

[Replacing the Maintenance Box](#)

Checking Ink Cartridge and Maintenance Box Status with Windows

You can check your ink cartridge or maintenance box status at any time using a utility on your Windows computer.

1. To check your status, access the Windows Desktop and click the  icon for your product in the right side of the Windows taskbar, or click the up arrow and click . Then click your product name.

You see a screen like this:

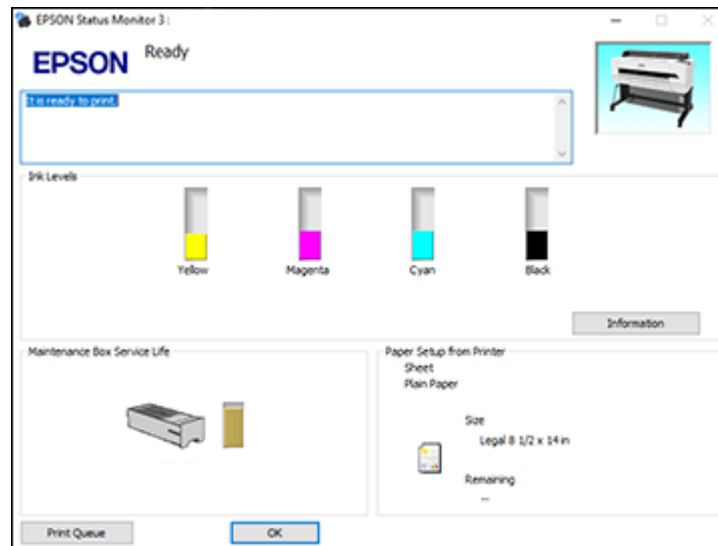

2. Replace or reinstall the ink cartridge or maintenance box as indicated on the screen.

Note: If any of the ink cartridges installed in the product is broken, incompatible with the product model, or improperly installed, Epson Status Monitor will not display an accurate ink status.

Parent topic: [Check Cartridge and Maintenance Box Status](#)

Related tasks

[Removing and Installing Ink Cartridges](#)

[Replacing the Maintenance Box](#)

Checking Cartridge and Maintenance Box Status - Mac

You can check the status of your ink cartridges and maintenance box using a utility on your Mac.

1. In the Apple menu or the Dock, select **System Preferences**. Select **Print & Fax**, **Print & Scan**, or **Printers & Scanners**, select your product, and select **Options & Supplies**. Select **Utility** and select **Open Printer Utility**.
2. Select **EPSON Status Monitor**.

You see this window:

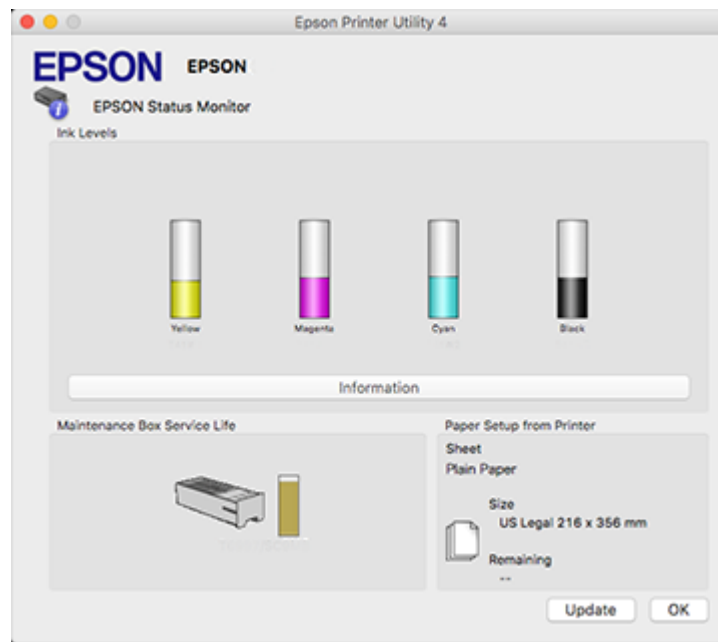

3. Do the following as necessary:

- You can update the ink cartridge and maintenance box status by clicking **Update**.
- Replace or reinstall the maintenance box or any ink cartridge as indicated on the screen.

Note: If any of the cartridges installed in the product is broken, incompatible with the product model, or improperly installed, Epson Status Monitor will not display an accurate cartridge status.

Parent topic: [Check Cartridge and Maintenance Box Status](#)

Related tasks

[Removing and Installing Ink Cartridges](#)

[Replacing the Maintenance Box](#)

Purchase Epson Ink Cartridges and Maintenance Box

You can purchase genuine Epson ink, maintenance boxes, and paper at epson.com (U.S. sales), epson.ca (Canadian sales), or epson.com.jm (Caribbean sales). You can also purchase supplies from an Epson authorized reseller. To find the nearest one, call 800-GO-EPSON (800-463-7766) in the U.S. or 800-807-7766 in Canada.

Note: This product is designed to work with genuine Epson inks. Non-Epson ink or any other ink not specified for this printer could cause damage not covered by Epson's warranties.

[Ink Cartridge and Maintenance Box Part Numbers](#)

Parent topic: [Replacing Ink Cartridges and Maintenance Boxes](#)

Ink Cartridge and Maintenance Box Part Numbers

Use these part numbers when you order or purchase a new ink cartridge or maintenance box.

Note: For best printing results, use up a cartridge within 6 months of opening the package.

Maintenance box part number: T699700

Ink color	110 ml	350 ml	700 ml
Black	T41W520	T41P520	T41N520
Cyan	T41W220	T41P220	T41N220
Magenta	T41W320	T41P320	T41N320
Yellow	T41W420	T41P420	T41N420

Parent topic: [Purchase Epson Ink Cartridges and Maintenance Box](#)

Removing and Installing Ink Cartridges

Make sure you have your replacement cartridges handy before you begin. You must install new cartridges immediately after removing the old ones.

Note: Replace all expended ink cartridges. You cannot print if any of the ink cartridges are expended or missing.

1. Turn on your product.

2. Open the ink cartridge cover.

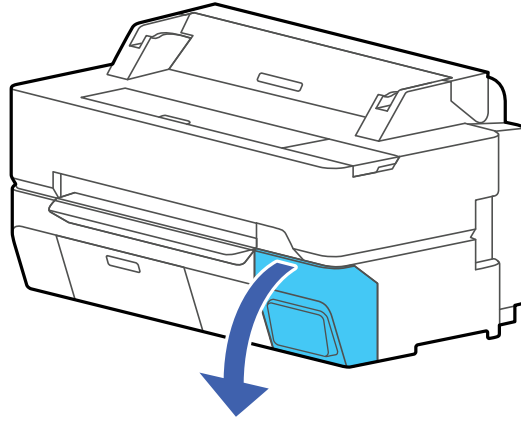

3. Remove the new ink cartridge from the bag and gently shake it horizontally for about 10 seconds (approximately 30 times).

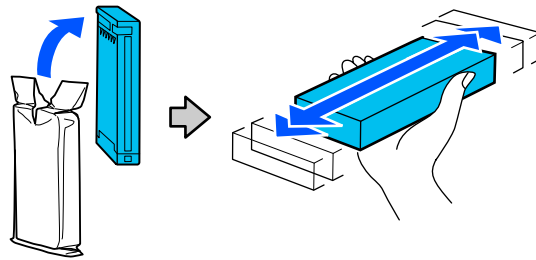

Caution: Do not touch the chip on the cartridge.

4. Using the indentation on top of the cartridge, pull the old cartridge out of the printer.

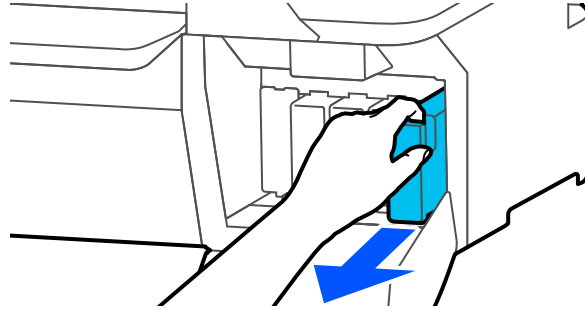

5. With the label facing you, slide the new ink cartridge all the way into the slot.

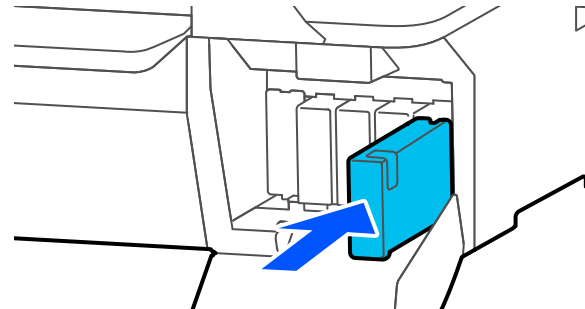

Note: Make sure to insert the cartridge into the correct color location

6. Repeat steps 3 to 5 as necessary to replace any other cartridges.

7. Close the ink cartridge cover.

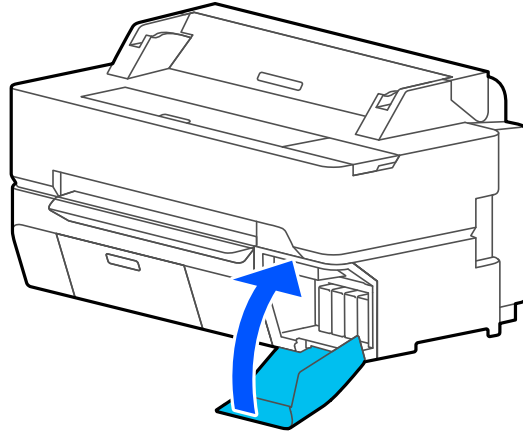

Caution: If you remove an ink cartridge for later use, protect the ink supply area from dirt and dust and store it in the same environment as the printer. The valve in the ink supply is designed to contain any excess ink, but do not touch the ink supply port or surrounding area.

Parent topic: [Replacing Ink Cartridges and Maintenance Boxes](#)

Related concepts

[Purchase Epson Ink Cartridges and Maintenance Box](#)

Replacing the Maintenance Box

Replace the maintenance box when a message or icon is displayed on the LCD screen telling you that the maintenance box is near or at the end of its service life.

Note: The SureColor T5475 has two maintenance boxes located behind the maintenance box cover.

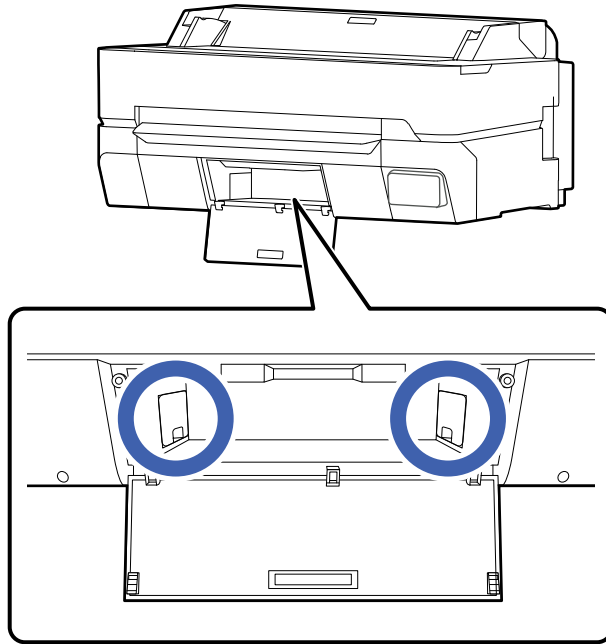

Note: You can view the replacement procedure on the LCD screen. Press the  home button if necessary and select **Settings > Maintenance > Replace Maintenance Box > See Guide**.

1. Open the maintenance box cover.

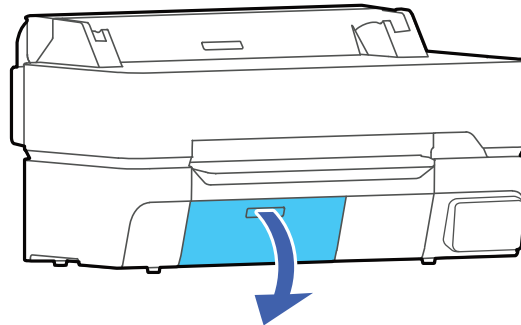

2. Pull out the maintenance box.

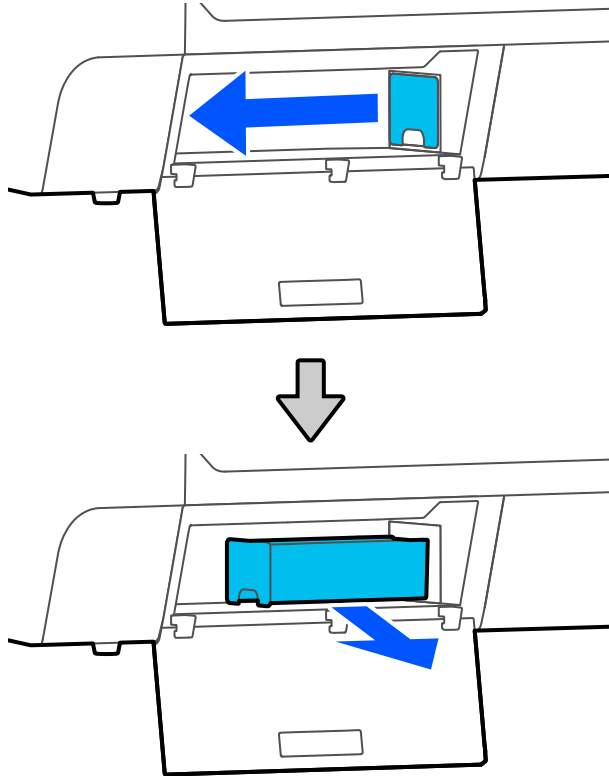

Warning: If ink gets on your skin, wash it thoroughly with soap and water. If ink gets into your eyes, flush them immediately with water. If ink gets into your mouth, spit it out and see a doctor right away.

3. Place the used maintenance box in the clear plastic bag (included with the replacement maintenance box) and make sure it is closed tightly.

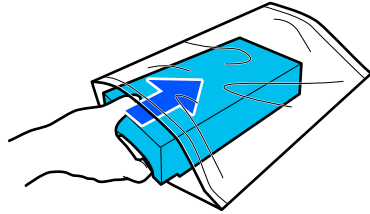

4. Remove the new maintenance box from the package.
5. Insert the new maintenance box into the printer.

Caution: Do not touch the chip on the maintenance box or you may damage the product.

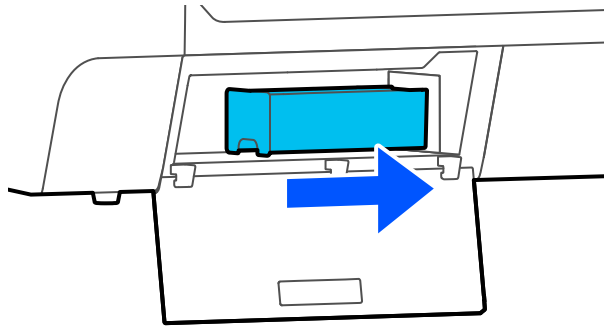

Note: Repeat the above procedure for the second maintenance box on the SureColor T5475, if necessary. If you are only replacing one of the maintenance boxes, make sure it is the correct one.

6. Close the maintenance box cover.

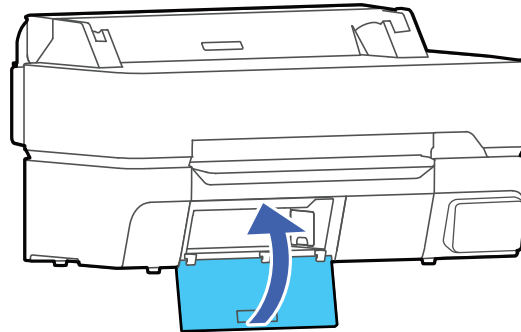

Parent topic: [Replacing Ink Cartridges and Maintenance Boxes](#)

Related concepts

[Purchase Epson Ink Cartridges and Maintenance Box](#)

Related references

[Optional Equipment and Replacement Parts](#)

Adjusting Print Quality

If your print quality declines, you may need to run a utility to clean or align the print head.

If running these utilities does not solve the problem, you may need to replace the ink cartridges.

[Print Head Maintenance](#)

[Using Easy Adjustment](#)

[Adjusting Paper Feed Using the Product Control Panel](#)

[Adjusting Print Length Using the Product Control Panel](#)

[Aligning the Print Head Using the Product Control Panel](#)

[Cleaning the Roll Paper Feeder](#)

Print Head Maintenance

If your printouts become too light, or you see dark or light bands across them, you may need to clean the print head nozzles. Cleaning uses ink, so clean the nozzles only if print quality declines.

You can check for clogged nozzles before you clean them so you don't clean them unnecessarily.

Note: You cannot clean the print head if an ink cartridge is expended, and may not be able to clean it when a cartridge is low. You must replace the cartridge first.

[Print Head Nozzle Check](#)

[Print Head Cleaning](#)

Parent topic: [Adjusting Print Quality](#)

Related tasks

[Removing and Installing Ink Cartridges](#)

Print Head Nozzle Check

You can print a nozzle check pattern to check for clogged nozzles.

[Checking the Nozzles Using the Product Control Panel](#)

[Checking the Nozzles Using a Computer Utility](#)

Parent topic: [Print Head Maintenance](#)

Checking the Nozzles Using the Product Control Panel

You can check the print head nozzles using the control panel on your product.

1. Make sure roll paper or cut sheet paper is loaded in the printer.
2. Press the  home button, if necessary.
3. Select **Settings** > **Maintenance** > **Print Head Nozzle Check**.

You see a screen like this:

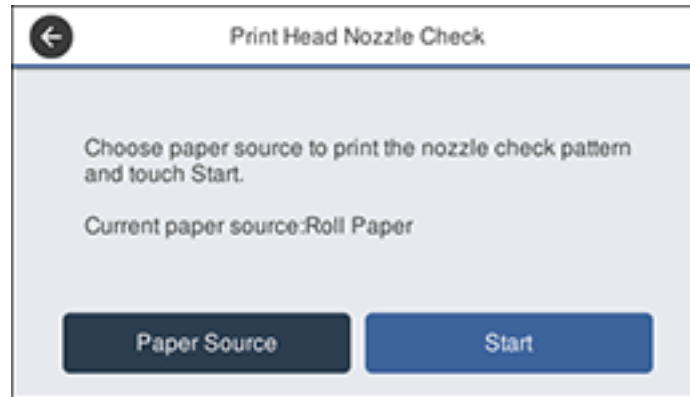

4. If you want to change the paper source that the nozzle check pattern prints on, select **Paper Source**. Otherwise, select **Start** to print the nozzle check pattern.

The nozzle check pattern prints.

5. Check the printed pattern to see if there are gaps in the lines.

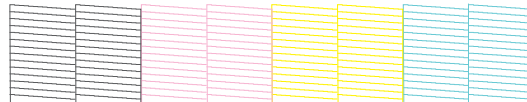

Print head is clean

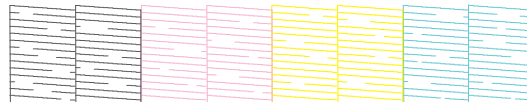

Print head needs cleaning



6. Do one of the following:

- If there are no gaps in the pattern, select the  icon.
- If there are gaps or the pattern is faint, select the  icon on the **Head Cleaning** screen. Select **Start** to clean the print head.

If you don't see any improvement after cleaning the print head three times, perform a **Powerful Cleaning**.

Parent topic: [Print Head Nozzle Check](#)

Related tasks



[Checking the Nozzles Using a Computer Utility](#)

[Cleaning the Print Head Using the Product Control Panel](#)

[Using the Powerful Cleaning Utility](#)

Checking the Nozzles Using a Computer Utility

You can check the print head nozzles using a utility on your Windows or Mac computer.

1. Make sure roll paper or cut sheet paper is loaded in the printer.
2. Do one of the following:
 - **Windows:** Access the Windows Desktop and click the  icon for your product in the right side of the Windows taskbar, or click the up arrow and click .
 - **Mac:** In the Apple menu or the Dock, select **System Preferences**. Select **Print & Fax**, **Print & Scan**, or **Printers & Scanners**, select your product, and select **Options & Supplies**. Select **Utility** and select **Open Printer Utility**.
3. Select **Nozzle Check**.

You see a window like this:

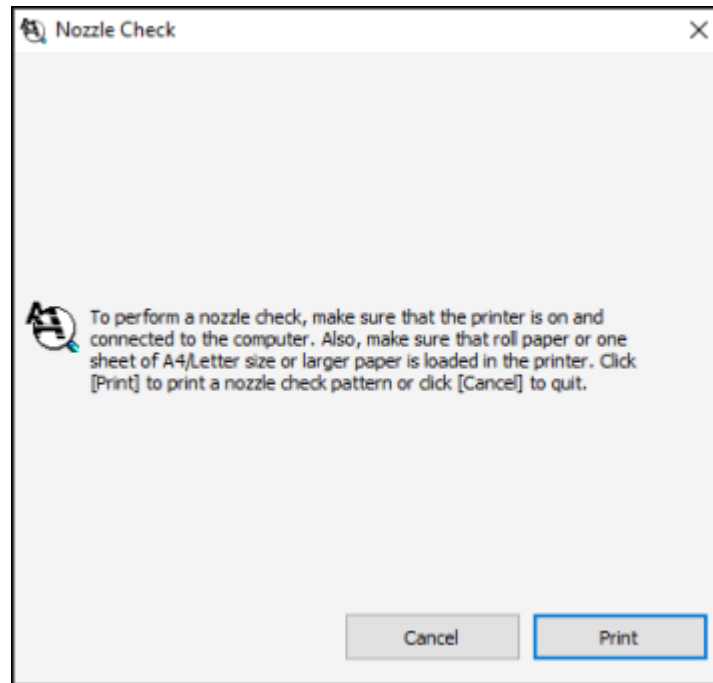

4. Click **Print**.
The nozzle pattern prints.

5. Check the printed pattern to see if there are gaps in the lines.

Print head is clean

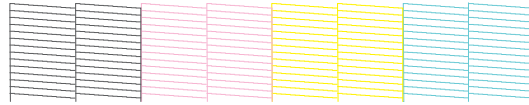

Print head needs cleaning

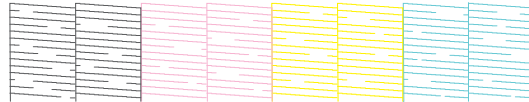

6. If there are no gaps in the pattern, click **Finish**.

If there are gaps or the pattern is faint, click **Clean**.

If you don't see any improvement after cleaning the print head three times, perform a **Powerful Cleaning**.

Parent topic: [Print Head Nozzle Check](#)

Related tasks

[Checking the Nozzles Using the Product Control Panel](#)

[Cleaning the Print Head Using a Computer Utility](#)

[Using the Powerful Cleaning Utility](#)

Print Head Cleaning

If print quality has declined and the nozzle check pattern indicates clogged nozzles, you can clean the print head.

Note: Your printer automatically checks the print head nozzles when the printer is turned on and before printing; and cleans them when it detects clogged nozzles. To change this setting, select **Settings > General Settings > Printer Settings > Self Check and Cleaning**.

Note: You cannot clean the print head if an ink cartridge is expended, and may not be able to clean it when a cartridge is low. You must replace the cartridge first.

[Cleaning the Print Head Using the Product Control Panel](#)

[Cleaning the Print Head Using a Computer Utility](#)

[Using the Powerful Cleaning Utility](#)

Parent topic: [Print Head Maintenance](#)

Cleaning the Print Head Using the Product Control Panel

You can clean the print head using the control panel on your product.

1. Make sure roll paper or cut sheet paper is loaded in the printer.
2. Press the  home button, if necessary.
3. Select **Settings > Maintenance > Head Cleaning**.

You see a screen like this:

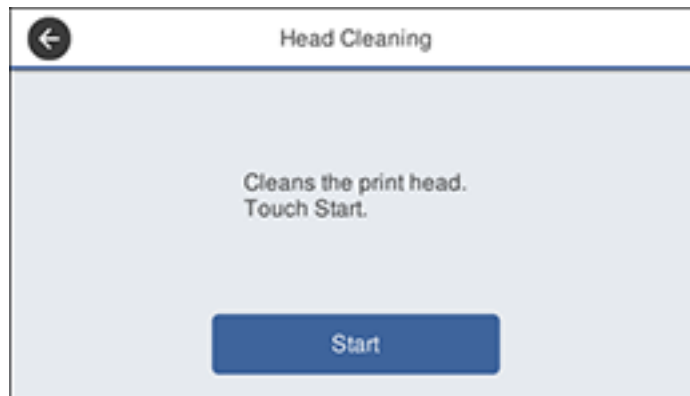

4. Select **Start** to begin the cleaning cycle.

When the cleaning cycle is finished, the  power light stops flashing and a confirmation screen appears.

Caution: Never open any covers or turn off the product during a cleaning cycle or you may damage it.

5. Select **Yes** to print a nozzle check pattern.

The nozzle pattern prints.

6. Check the printed pattern to see if there are gaps in the lines.

Print head is clean

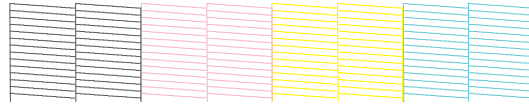

Print head needs cleaning

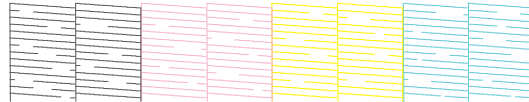

7. Follow the instructions on the screen to clean the print head, check the nozzles, and repeat the process as necessary.

If you don't see any improvement after cleaning the print head three times, perform a **Powerful Cleaning**.

Parent topic: [Print Head Cleaning](#)

Related tasks



[Cleaning the Print Head Using a Computer Utility](#)

[Using the Powerful Cleaning Utility](#)

[Checking the Nozzles Using the Product Control Panel](#)

Cleaning the Print Head Using a Computer Utility

You can clean the print head using a utility on your Windows computer or Mac.

1. Make sure roll paper or cut sheet paper is loaded in the printer.
2. Do one of the following:
 - **Windows:** Access the Windows Desktop and click the  icon for your product in the right side of the Windows taskbar, or click the up arrow and click .
 - In the Apple menu or the Dock, select **System Preferences**. Select **Print & Fax**, **Print & Scan**, or **Printers & Scanners**, select your product, and select **Options & Supplies**. Select **Utility** and select **Open Printer Utility**.
3. Select **Head Cleaning**.

You see a window like this:

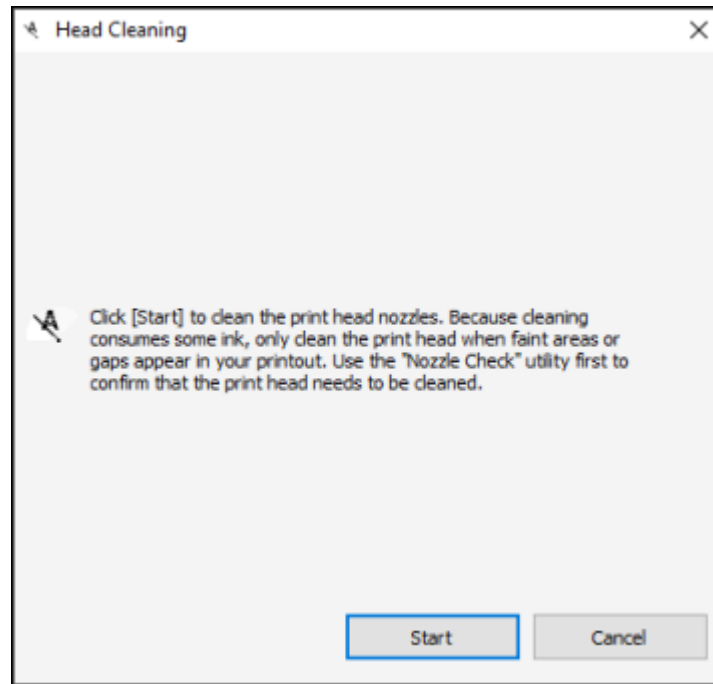

4. Click **Start** to begin the cleaning cycle.

When the cleaning cycle is finished, the  power light stops flashing and a confirmation screen appears.

Caution: Never open any covers or turn off the product during a cleaning cycle or you may damage it.

5. Click **Print Nozzle Check Pattern**.

The nozzle pattern prints.

6. Check the printed pattern to see if there are gaps in the lines.

Print head is clean

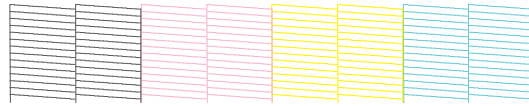

Print head needs cleaning

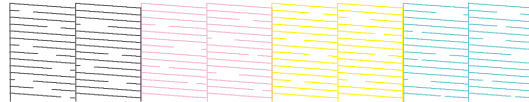

If you don't see any improvement after cleaning the print head three times, perform a **Powerful Cleaning**.

Parent topic: [Print Head Cleaning](#)

Related tasks

[Cleaning the Print Head Using the Product Control Panel](#)

[Using the Powerful Cleaning Utility](#)

[Checking the Nozzles Using a Computer Utility](#)

Using the Powerful Cleaning Utility

If print head nozzles are still clogged after cleaning the print head three times, run the **Powerful Cleaning** utility from the product control panel. This process consumes a lot of ink to clean the clogged nozzles.

1. Press the  home button, if necessary.
2. Select **Settings** > **Maintenance** > **Powerful Cleaning**.

You see a screen like this:

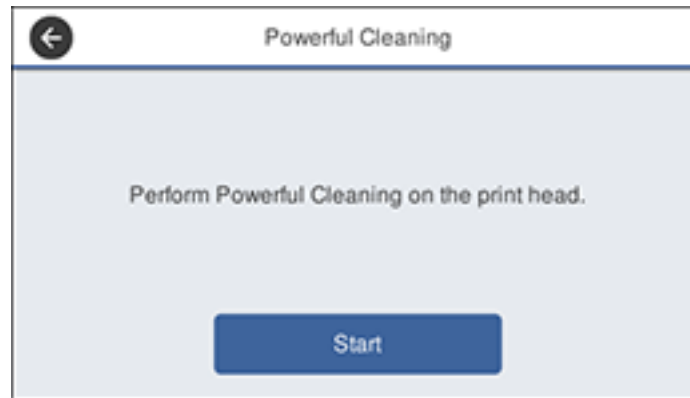

3. Select **Start** to begin the cleaning cycle.

When the cleaning cycle is finished, the  power light stops flashing and a confirmation screen appears.

Caution: Never open any covers or turn off the product during a cleaning cycle or you may damage it.

4. Select **Yes** > **Start** to print a nozzle check pattern.

The nozzle pattern prints.

5. Check the printed pattern to see if there are gaps in the lines.

Print head is clean

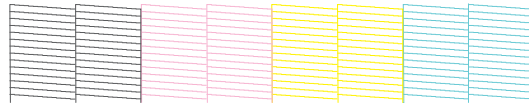

Print head needs cleaning

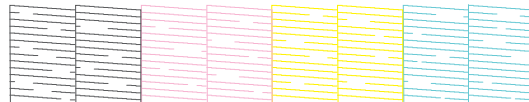

If nozzles are still clogged, turn off the printer and leave it off overnight. If nozzles are still clogged, contact Epson for support.

Parent topic: [Print Head Cleaning](#)

Related tasks

[Checking the Nozzles Using a Computer Utility](#)

[Checking the Nozzles Using the Product Control Panel](#)

[Cleaning the Print Head Using the Product Control Panel](#)

[Cleaning the Print Head Using a Computer Utility](#)

Using Easy Adjustment

You can use Easy Adjustment to run the Paper Feed Adjust and Print Head Alignment functions and automatically optimize the settings.

Use Easy Adjustment in the following cases:

- You create custom paper settings

Note: Even if the paper types are the same, roll paper and cut sheets will require different optimized paper settings. You should run an Easy Adjustment for roll paper and cut sheet paper types separately.

- You notice streaking, horizontal banding, or uneven colors in your printouts

- You notice duplicate ruled lines, warped lettering, or grainy printing in your printouts

To use Easy Adjustment successfully, do the following:

- Correctly load the paper and select the appropriate paper type
 - Do not use paper with visible curls, wrinkles, waves, folds, or bends
 - Make sure direct sunlight does not enter the printer (it can interfere with the sensor)
 - Do not use transparent or colored media
1. Make sure roll paper or cut sheet paper is loaded in the printer. You need at least this much paper to print the adjustment pattern:
 - Roll paper: 13.5 inches (344 mm)
 - Cut sheet feeder: 1 sheet of paper sized A3+ (13 × 19 inches [329 × 483 mm]) or larger, or 2 sheets of paper smaller than A3+ (13 × 19 inches [329 × 483 mm]), loaded one at a time
 2. Press the  home button, if necessary.
 3. Do one of the following:
 - **Roll paper:** Select Roll paper information area > **Media Adjust** > **Easy Adjustment**.
 - **Cut Sheet:** Select **Paper Setting** > **Cut Sheet (1 sheet)** > **Media Adjust** > **Easy Adjustment**
 4. Select **Start** to begin the adjustment process.

When the adjustment cycle is finished, a confirmation screen appears.

If you get an error message when using Easy Adjustment or want to run the automatic adjustment cycles separately, you can select the **Media Adjust** menu item for your paper source and select either **Paper Feed Adjust - Manual** or **Print Head Alignment - Manual**.

Parent topic: [Adjusting Print Quality](#)

Related tasks

[Aligning the Print Head Using the Product Control Panel](#)

[Adjusting Print Length Using the Product Control Panel](#)

Adjusting Paper Feed Using the Product Control Panel

If your printouts become grainy or blurry, or you see dark or light horizontal bands, you may need to adjust the paper feed using the product control panel.

1. Make sure roll paper or cut sheet paper is loaded in the printer.

Note: You need at least this much paper to print the adjustment pattern:

- Roll paper: 6.1 inches (156 mm)
- Cut sheet feeder: 2 sheets of A4 (8.3 × 11.7 inches [210 × 297 mm]) or larger, loaded one sheet at a time

2. Press the  home button, if necessary.

3. Select one of the following:

- **Roll paper:** Select the roll paper information area and select **Media Adjust > Paper Feed Adjust - Manual**.
- **Cut sheet:** Select **Paper Setting > Cut Sheet (1 sheet) > Media Adjust > Paper Feed Adjust - Manual**

4. Select **Start** to print an adjustment pattern.

The first set of adjustment patterns prints.

Note: If you are printing on roll paper with **Auto Cut** turned off, do not remove or pull out the paper until the second set of alignment patterns prints.

5. Follow the instructions on the LCD screen to select the best patterns for the first set of adjustment patterns and select **OK**.

The second set of adjustment patterns prints.

Note: If you are printing on cut sheets smaller than A2 (16.5 × 23.4 inches [420 × 594 mm]) size, load the second sheet of paper.

6. Follow the instructions on the LCD screen to select the best patterns for the second set of adjustment patterns, and select **OK**.

The screen displays a confirmation message and returns to the home screen.

Parent topic: [Adjusting Print Quality](#)

Related references

[Paper Setting Menu](#)

Related tasks

[Loading Roll Paper](#)

Adjusting Print Length Using the Product Control Panel

If your roll paper printouts need to match the length of the print data exactly, such as with CAD drawings, you can adjust the print length.

Note: You will need a ruler to perform the adjustment. The print length adjustment is saved with the chosen paper type, so make sure you load the correct roll paper.

1. Make sure at least 21.8 inches (555 mm) of roll paper is loaded in the printer.
2. Press the  home button, if necessary.
3. Select the roll paper information area and select **Media Adjust > Paper Feed Adjust > Print length adjustment**.
4. Select **Start** to print the adjustment pattern.
5. Using a ruler, measure the distance between the + symbols.

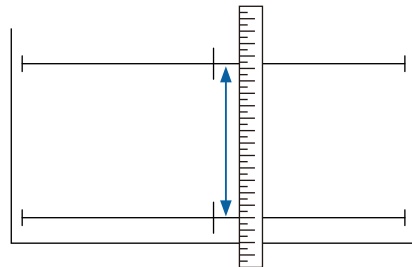

6. Enter the measured length on the LCD screen and select **OK**.
After adjustment, the screen displays a confirmation message.

Parent topic: [Adjusting Print Quality](#)

Related tasks

[Loading Roll Paper](#)

Aligning the Print Head Using the Product Control Panel

If your printouts become grainy or blurry, or you notice misalignment of vertical lines, you may need to align the print head using the product control panel.

1. Make sure roll paper or cut sheet paper is loaded in the printer. You need at least this much paper to print the adjustment pattern:
 - Roll paper: 11.2 inches (285 mm)
 - Cut sheet feeder: 1 sheet of paper sized A4 (8.3 × 11.7 inches [210 × 297 mm]) or larger
2. Press the  home button, if necessary.
3. Do one of the following:
 - **Roll paper:** Select the roll paper information area and select **Media Adjust > Print Head Alignment - Manual**.
 - **Cut sheet:** Select **Paper Setting > Cut Sheet (1 sheet) > Media Adjust > Print Head Alignment - Manual**
4. Select **Start** to print the adjustment pattern.
5. Follow the instructions on the LCD screen to select the best patterns for each set of adjustment patterns and select **OK**.

The screen displays a confirmation message and returns to the home screen.

Parent topic: [Adjusting Print Quality](#)

Related references

[Paper Setting Menu](#)



Related tasks

[Loading Roll Paper](#)

[Loading Single Cut Sheets](#)

Cleaning the Roll Paper Feeder

If ink smears on a printout when printing on roll paper or cut sheets, you can clean the roll paper feeder to remove excess ink.

1. Load the widest available roll paper in the printer.
2. Press the  home button, if necessary.
3. Select **Paper Setting > Roll Paper > Feed/Cut Paper**.
4. Press and hold  **Forward** until there are no ink smears on the ejected roll paper.
5. Select  **Cut** to cut the roll paper.

Parent topic: [Adjusting Print Quality](#)

Related references

[Paper Setting Menu](#)

Related tasks

[Loading Roll Paper](#)

Maintenance and Transportation

See the instructions in these sections to maintain your printer for optimum results, or to move or transport your printer.

[Replacing the Cutter](#)

[Replacing the Borderless Pads](#)

[Cleaning the Platen and Borderless Pad Edges](#)

[Moving or Transporting Your Product](#)

Replacing the Cutter

If you notice that your paper does not cut cleanly, you may need to replace the cutter (part number S902007). You will need a Phillips-head screwdriver.

Caution: Do not remove the protective material from the new cutter until instructed to do so. Do not drop the cutter or knock it against anything or you may chip the blade.

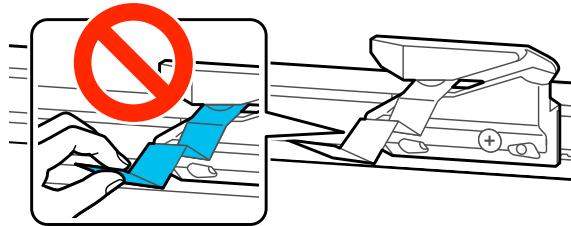

1. Remove all paper from the printer.
2. Press the  home button, if necessary.
3. Select **Settings** > **Maintenance** > **Replace Cutter** > **Start**.
The cutter moves to the replacement position.

4. Use a Phillips-head screwdriver to loosen the screw holding the cutter in place and carefully pull the cutter straight out. Place the cutter in a plastic bag and dispose of it properly.

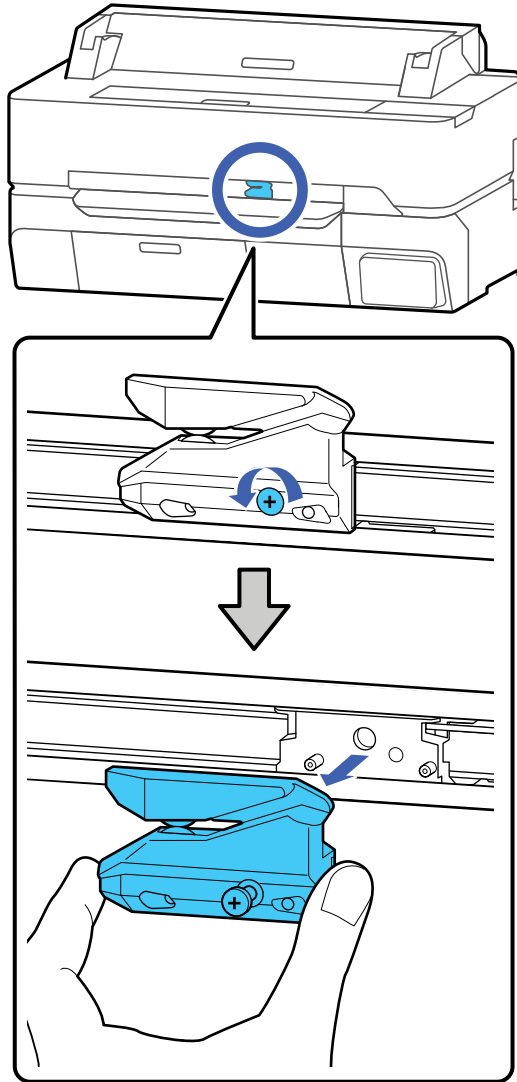

Warning: Keep the cutter out of the reach of children. The blade is sharp and can cause injury.

5. Align the pin on the new cutter with the hole in the product and insert the cutter. Tighten the cutter screw securely.

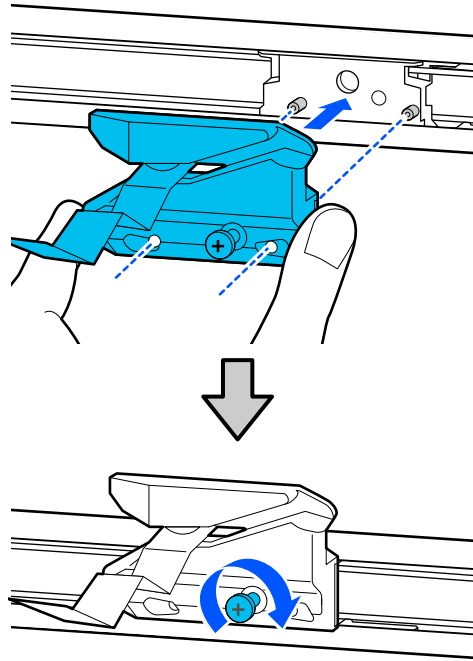

Note: Make sure the screw is tightened securely, otherwise the cut position may shift slightly.

6. Select **OK**.
The cutter moves into position and cuts off the protective piece. Remove the protective piece from the printer.

Parent topic: [Maintenance and Transportation](#)

Related references

[Optional Equipment and Replacement Parts](#)

Replacing the Borderless Pads

If you see smearing or ink on the back of your prints, you may need to replace the pads for borderless printing. Only replace the borderless pads in the areas where you notice ink on your prints. You do not need to replace all of the borderless pads.

You will need a Borderless Replacement Pad Kit (part number C13S400064) to perform the replacement.

1. Turn off the product, wait for the LCD screen to turn off, and unplug the power cable from the electrical outlet.
2. Wait for one minute before continuing.
3. Open the front cover.

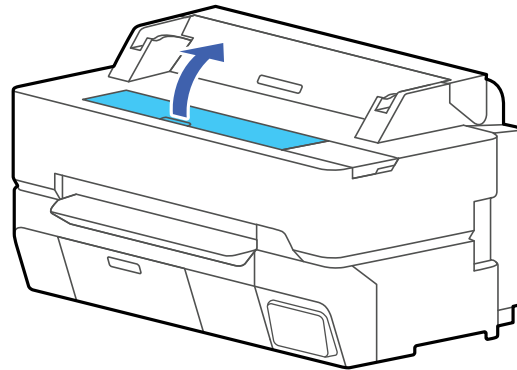

- Using tweezers, pull out the borderless pads in the areas where ink transfer occurs.

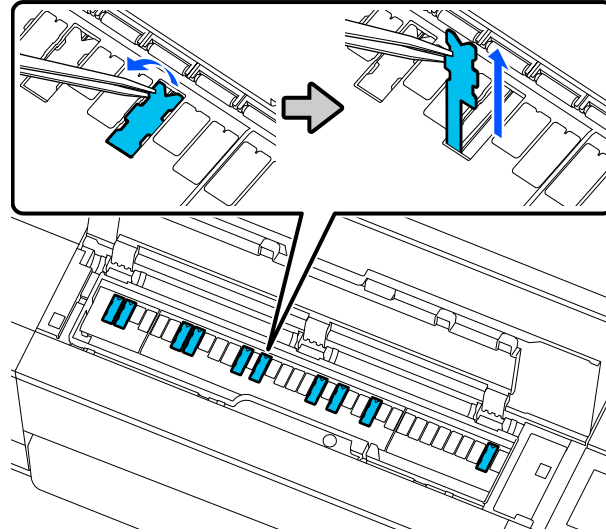

- Use cleaning sticks to wipe off the accumulated ink in the following locations:

Bottom

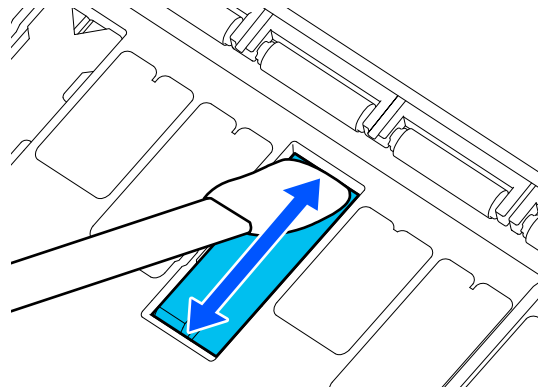

Sides

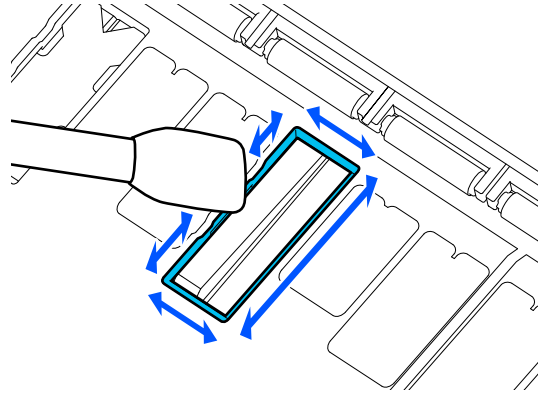

Center groove

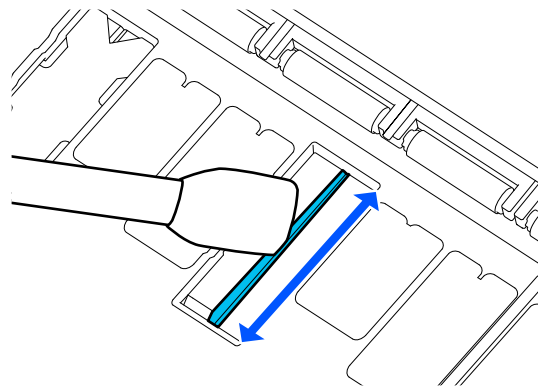

6. Bend a new borderless pad as shown below.

Note: Do not bend the borderless pad except at the designated spot.

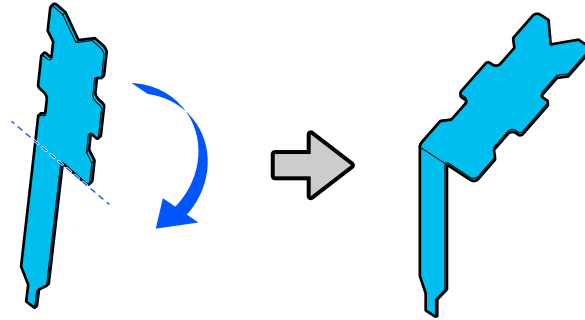

7. Insert the leg of the borderless pad all the way into the hole.

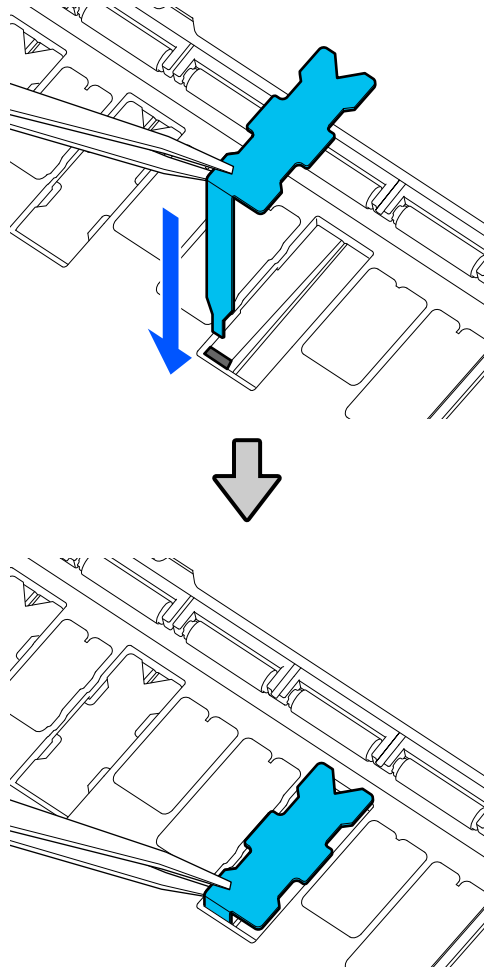

8. Push the protrusions on the sides of the borderless pad into the grooves on the left and right.

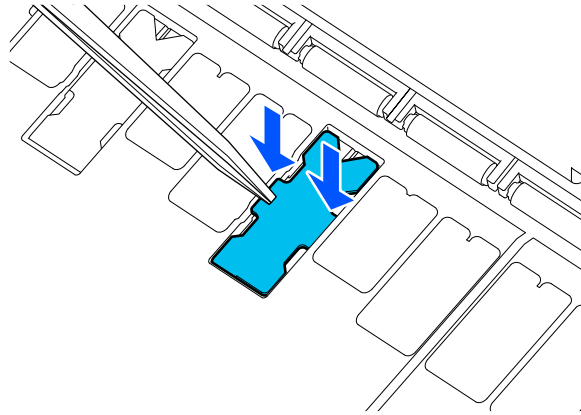

9. Gently press the borderless pad until it is seated in place.

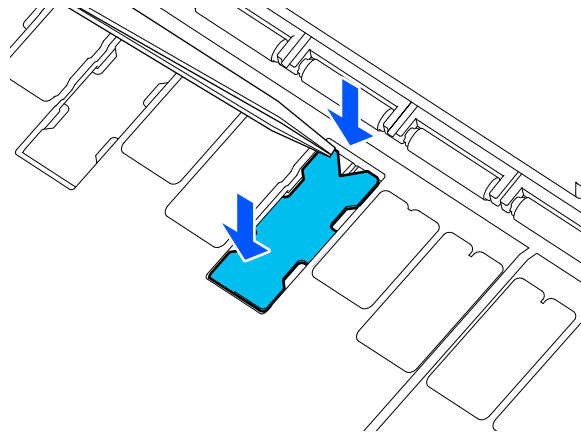

Caution: Make sure that no part of the borderless pad extends above the surrounding surface. The borderless pad may rub against the print head and damage it.

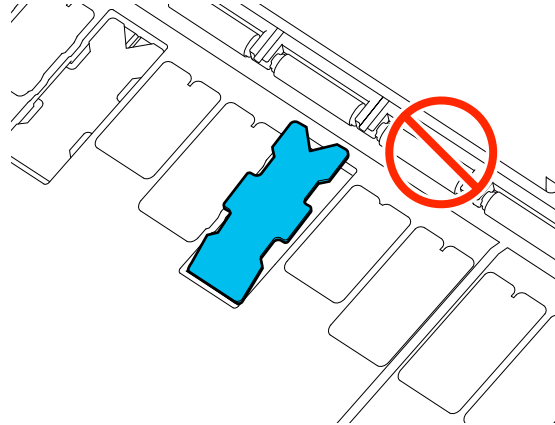

Parent topic: [Maintenance and Transportation](#)

Related references

[Optional Equipment and Replacement Parts](#)

Cleaning the Platen and Borderless Pad Edges

Carefully follow the steps here to clean the platen and borderless pad edges to remove ink, paper particles, and lint.

Caution: If ink remains on these parts, it could transfer to your printouts. Continued use of your product with ink, paper particles, or lint on these surfaces could damage the print heads or clog the nozzles.

1. Turn off the product, wait for the LCD screen to turn off, and unplug the power cable from the electrical outlet.
2. Wait for one minute before continuing.

3. Open the front cover.

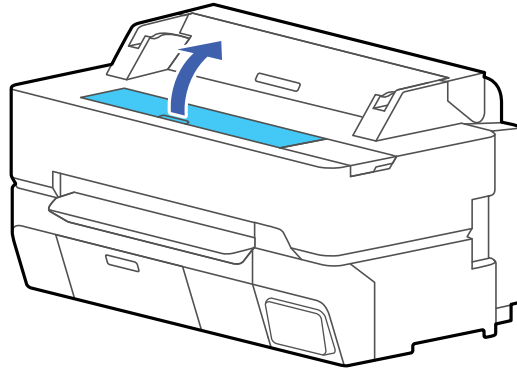

4. Use a soft cloth to remove dust and dirt from the platen. Thoroughly clean the area shown in blue in the image below. Wipe from the inside to the outside of the platen to clean it as shown here.

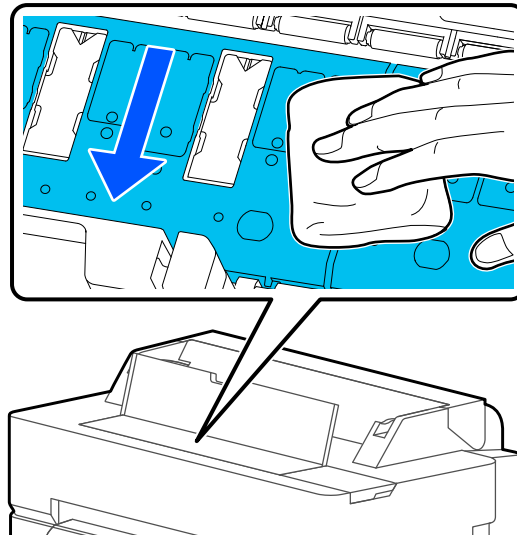

Note: For stubborn dirt, dampen a soft cloth with neutral detergent and wring it out, then clean the platen as shown above. Dry the platen with a soft, dry cloth when you are finished.

5. If any paper particles have accumulated in the holes shown in the illustration below, use a pointed object such as a toothpick to push the material into the holes.

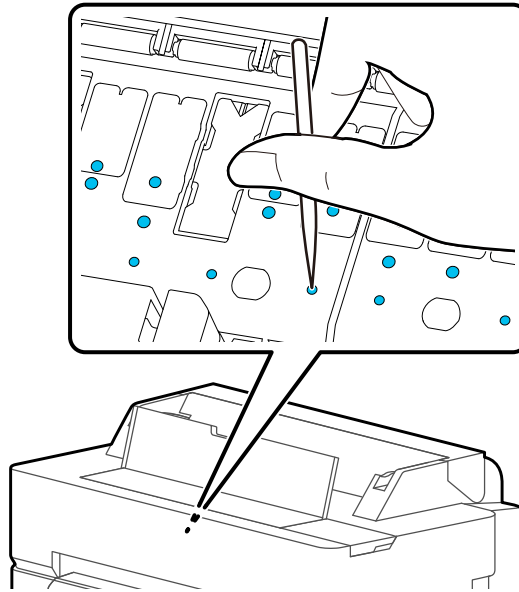

6. Remove any paper particles or dust around the outer edges of the borderless pads using cotton swabs.

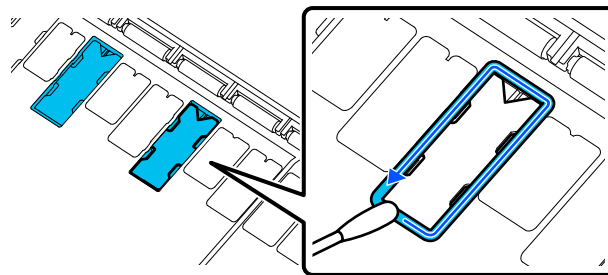

7. Close the front cover, plug in the power cord, and turn the product back on.

Parent topic: [Maintenance and Transportation](#)

Moving or Transporting Your Product

If you need to move or transport your product, prepare it as described here.

Caution: During transportation and storage, follow these guidelines:

- Avoid tilting the product, placing it vertically, or turning it upside down; otherwise ink may leak.
- Leave the ink cartridges installed. Removing the cartridges can dry out the print head and may prevent the product from printing, or ink may leak.

Note: Before storing your product for a long period, replace low, expended, or expired ink to help prevent the print head from drying out. Store your product in a cool, dry place.

1. Remove all the paper from the product.
2. Turn off the product.
3. Unplug the power cable.
4. Disconnect any connected cables.
5. Close all covers on the product.
6. If you are moving the product without the stand, you will need two people for the SureColor T3475, and three for the SureColor T5475. Lift the product using the indented areas as shown.

SureColor T3475

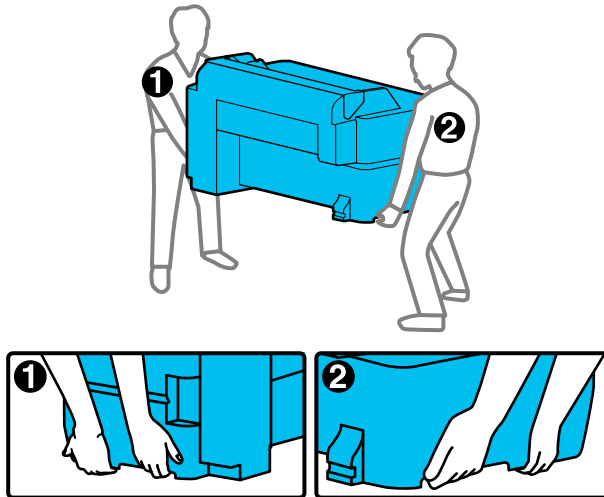

SureColor T5475

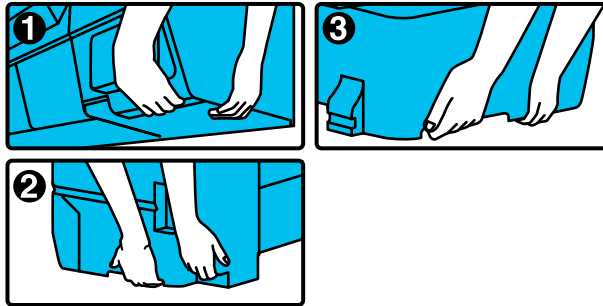
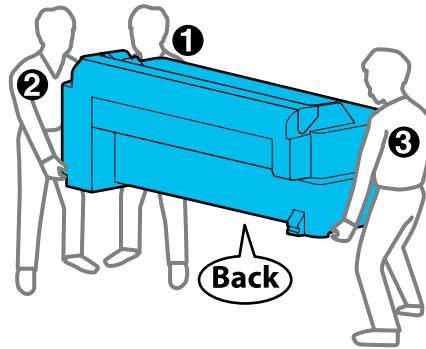

Warning: The product is heavy and requires two or more people to move it. When lifting the SureColor T5475, do not hold the printer by the area shown below:

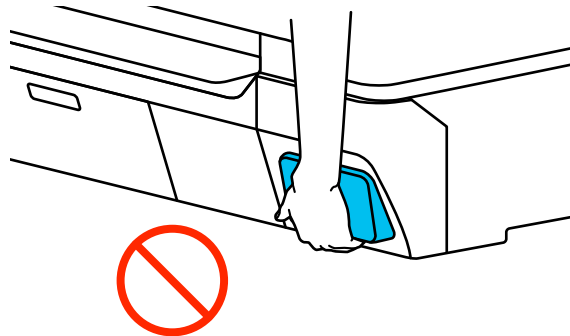

7. If you are moving the product on the stand, do the following:
 - Close the paper basket.
 - Release the caster locks.
 - Move the product on an even floor surface.
 - Lock the casters in the new location.

Caution: Do not move the product with locked casters. Avoid areas with steps or uneven flooring.

Note: If you are transporting or storing the product below 14°F (–10°C), you must discharge the ink. See the link below for instructions.

8. If you are transporting the product, place it in its original packing materials, if possible, or use equivalent materials with cushioning around the product.
9. After the printer is moved, connect the power cable and turn on the printer.
10. Run a print head nozzle check and clean the print head, if necessary.

[Discharging Ink](#)

Parent topic: [Maintenance and Transportation](#)

Related tasks

[Cleaning the Print Head Using the Product Control Panel](#)

[Checking the Nozzles Using the Product Control Panel](#)

Discharging Ink

If you need to move or transport your product when the temperature is 14°F (–10°C) or lower, you must first discharge the ink to keep the print head in optimum condition.

Note: The maintenance box needs enough capacity to discharge the ink. Replace the maintenance box first if the remaining capacity is low.

1. Turn on the product.
2. Remove all the paper from the product.
3. Press the  home button, if necessary.
4. Select **Settings > Maintenance > Discharging/Charging Ink > Start**.

The ink begins to discharge. The power turns off automatically when the discharge process is complete.

Caution: Do not open any product cover or turn off the product while ink is discharging.

Parent topic: [Moving or Transporting Your Product](#)

Related tasks

[Checking Ink Cartridge and Maintenance Box Status on the LCD Screen](#)

Solving Problems

Check these sections for solutions to problems you may have using your product.

[Checking for Software Updates](#)

[Product Status Messages](#)

[Resetting Control Panel Defaults](#)

[Solving Printer Problems](#)

[Solving Network Problems](#)

[Solving Printing Problems](#)

[Solving Paper Problems](#)

[Solving Print Quality Problems](#)



[Cannot Make Enlarged Copies from Scanner](#)

[Uninstall Your Product Software](#)

[Where to Get Help](#)

Checking for Software Updates

Periodically, it's a good idea to check Epson's support website for free updates to your product software. Visit epson.com/support (U.S.), epson.ca/support (Canada), or epson.com.jm/support (Caribbean) and select your product.

- **Windows:** Your printer software automatically checks for updates. You can also manually update the software by selecting **Software Update** here:
 - Access the Windows Desktop and right-clicking the  icon for your product in the right side of the Windows taskbar, or clicking the up arrow and right-clicking .
 - On the **Maintenance** tab in the printer settings window

You can also update the software by selecting **EPSON Software Updater** in the **EPSON** or **EPSON Software** program group, accessible by the **Start** button, or on the **Start** or **Apps** screens, depending on your version of Windows.

- **OS X:** You can manually update the software by opening the **Applications > Epson Software** folder and selecting **EPSON Software Updater**.
- **macOS 10.12.x to 10.15.x:** You can manually update the software by opening the **App Store**, selecting **Updates**, searching for a software update option for Epson Software, and selecting **Update**.

Parent topic: [Solving Problems](#)

Product Status Messages

You can often diagnose problems with your product by checking the messages on the LCD screen.

LCD screen message	Condition/solution
Cannot recognize ink cartridges. Try installing again.	Remove and reinsert the ink cartridge. If the message persists, insert a new ink cartridge. Make sure the ink cartridges are at room temperature.
Ink is low.	The ink is low. Make sure you have a replacement ink cartridge handy.
The maintenance box is not recognized. Install it correctly.	Remove and reinsert the maintenance box. If the message persists, insert a new maintenance box.
There is not enough space in maintenance box to perform head cleaning. You can continue printing until replacement is required.	The maintenance box does not have enough capacity to store ink discharged in print head cleaning. Do not perform head cleaning until you replace the maintenance box with a new one. The used maintenance box may be reinstalled after cleaning is completed.
Command Error Check the printer driver setting.	Select Cancel to stop printing. Make sure that the printer driver you are using supports your product.
Scanner Error Refer to manual for details.	Release the scanner transportation lock as described in your scanner's <i>User's Guide</i> . Turn the printer and scanner off and on. If the message persists, contact Epson for support.
Recovery Mode	The printer restarted in recovery mode because the firmware update failed. Make sure the computer and printer are connected via USB and try updating the firmware again.
Maintenance Request Replace Parts Soon/End of Parts Service Life (maintenance request code)	A part used in the printer is nearing or at the end of its service life. Contact Epson for support and provide them with the displayed maintenance request code. The error persists until you replace the requested part.

LCD screen message	Condition/solution
Printer Error Printer error. Turn the power off and on again. See documentation or visit epson.com for details. (printer error code)	Turn off the printer, disconnect the power cable from the outlet and from the printer, and reconnect it. Turn on the printer again. If the message persists, contact Epson for support and provide them with the displayed printer error code.

Parent topic: [Solving Problems](#)

Resetting Control Panel Defaults

If you have a problem with settings on the product control panel, you can reset them to their factory defaults. You can choose which settings to reset or reset them all.

Note: This setting can be locked by an administrator. If you cannot access or change this setting, contact your administrator for assistance.

1. Press the  home button, if necessary.
2. Select **Settings** > **General Settings** > **System Administration** > **Restore Default Settings**.

You see a screen like this:

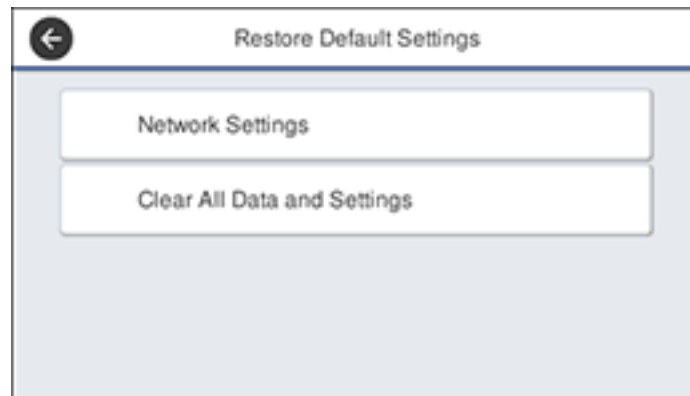

3. Select one of these options:
 - **Network Settings:** Resets all network settings.
 - **Clear All Data and Settings:** Resets all control panel settings except date and time, length unit, and language settings.

You see a confirmation screen.

4. Select **Yes** to reset the selected settings. (Select **No** if you want to cancel the operation.)

Parent topic: [Solving Problems](#)

Related references

[Where to Get Help](#)

Related tasks

[Removing and Installing Ink Cartridges](#)

[Replacing the Maintenance Box](#)

[Connecting a Scanner to Your Printer](#)

Solving Printer Problems

Check these sections if you have problems operating your product.

[Printer Does Not Turn On](#)

[LCD Screen Shuts Off](#)

Parent topic: [Solving Problems](#)

Printer Does Not Turn On

If the printer does not turn on, try these solutions:

- Make sure the power cable is securely connected.
- Make sure the power outlet works by connecting the power cable for another electronic device.

Parent topic: [Solving Printer Problems](#)

LCD Screen Shuts Off

If the LCD screen shuts off intermittently, the printer may be in sleep mode. Try these solutions:

- Press the touchscreen or any of the buttons on the control panel to exit sleep mode.
- You can adjust the delay time before the product enters sleep mode in the Basic Settings menu.

Parent topic: [Solving Printer Problems](#)

Related references

[Basic Settings Menu](#)

Solving Network Problems

Check these solutions if you have problems setting up or using your product on a network.

[Product Cannot Connect to a Wireless Router or Access Point](#)

[Network Software Cannot Find Product on a Network](#)

[Product Does Not Appear in Mac Printer Window](#)

[Cannot Print Over a Network](#)

Parent topic: [Solving Problems](#)

Product Cannot Connect to a Wireless Router or Access Point

If your product has trouble finding or connecting to a wireless router or access point, try these solutions:

- If you are connecting the product via Wi-Fi Protected Setup (WPS) and the Wi-Fi icon on your product's LCD screen is not lit or does not appear, make sure you select one of the WPS options from the product control panel within 2 minutes of pressing the WPS button on your router.
- Verify that your router or access point is operating correctly by connecting to it from your computer or another device.
- Print a network connection report and check the codes and messages on the report to help determine the cause of the problem.
- You may need to disable the firewall and any anti-virus software on your wireless router or access point.
- Try restarting your router following the instructions in your router documentation.

Note: If you are reading these instructions online, you will lose your Internet connection when you restart your router.

- Check to see if access restrictions, such as MAC address filtering, are set on the router or access point. If access restrictions are set, add your product's MAC address to your router's address list. To obtain your product's MAC address, print a network status sheet. Then follow the instructions in your router or access point documentation to add the address to the list.
- If your router or access point does not broadcast its network name (SSID), follow the instructions that came with your product to enter your wireless network name manually.

- If your router or access point has security enabled, determine the kind of security it is using and any required password or passphrase for connection. Then make sure to enter the exact WEP key or WPA passphrase correctly.
- Check if your computer is restricting the available wireless channels. If so, verify that your wireless access point is using one of the usable channels and change to a usable channel, if necessary.
- If you cannot connect your product to a device using Wi-Fi Direct, you may have exceeded the maximum number of devices connected to your product (8). Print a network status sheet or access Web Config on the browser for your device and check the number of connected devices. If 8 devices are already connected, disconnect a device by deleting the product's SSID from the Wi-Fi screen of that device. If fewer than 8 devices are connected, check the accuracy of your other network settings, move your device closer to your product, and try connecting again.
- If you are using a Wi-Fi Direct connection that suddenly disconnects, the Wi-Fi direct password on your device may have been changed. If necessary, delete the existing **DIRECT-xxxxxxx** connection settings from your device and enter a new password. See your device documentation for instructions.
- If you connected your product to a Windows computer using Wi-Fi Direct and it automatically selected Access Point Mode, you may have trouble accessing a low-priority Internet connection. Check the network connection or adapter settings in the Windows Control Panel and set the **Internet metric** setting to **100** for your version of the Internet Protocol.

Parent topic: [Solving Network Problems](#)

Related tasks

[Printing a Network Connection Report](#)

Network Software Cannot Find Product on a Network

If EpsonNet Setup cannot find your product on a network, try these solutions:

- Make sure your product is turned on and connected to your network. Verify the connection using your product control panel.
- Check if your network name (SSID) contains non-ASCII characters. Your product cannot display non-ASCII characters.
- Print a network connection report and check the codes and messages on the report to help determine the cause of the problem.
- Make sure your product is not connected to a guest network.
- If necessary, reinstall your product software and try running EpsonNet Setup again:
 1. Reset your product's network settings to their factory defaults.
 2. **Windows only:** Uninstall your product software.

3. Restart your router following the instructions in your router documentation.

Note: If you are reading these instructions online, you will lose your Internet connection when you restart your router, so note the next step before restarting it.

4. Download your product software from the Epson website using the instructions on the *Start Here* sheet.
- If you have replaced your router, reinstall your product software to connect to the new router.

Note: If you are using a 5 GHz wireless router, set the router to operate in dual band (2.4 GHz and 5 GHz) mode. If your router uses a single network name (SSID) for both the 2.4 GHz and 5 GHz band, give each band its own network name (SSID) instead, such as Home Network 2.4 GHz and Home Network 5 GHz. See your router documentation or contact your internet service provider for instructions.

- Check to see if your wireless router or access point has an enabled Privacy Separator function that is preventing detection of your device over the network. See your router or access point documentation for instructions on disabling the Privacy Separator function.

Parent topic: [Solving Network Problems](#)

Related concepts

[Uninstall Your Product Software](#)

Related tasks

[Resetting Control Panel Defaults](#)

[Printing a Network Connection Report](#)

Product Does Not Appear in Mac Printer Window

If your product does not appear in the Mac printer window, try these solutions:

- Turn your product off, wait 30 seconds, then turn it back on again.
- If you are connecting the product via Wi-Fi Protected Setup (WPS) and the Wi-Fi icon on your product's LCD screen is not lit, make sure you select one of the WPS options from the product control panel within 2 minutes of pressing the WPS button on your router.
- If you are connecting the product wirelessly via EpsonNet Setup and the Wi-Fi icon does not appear lit on your LCD screen, make sure your product software was installed correctly. If necessary, reinstall your software.

Note: If you are using a 5 GHz wireless router, set the router to operate in dual band (2.4 GHz and 5 GHz) mode. If your router uses a single network name (SSID) for both the 2.4 GHz and 5 GHz band, give each band its own network name (SSID) instead, such as Home Network 2.4 GHz and Home Network 5 GHz. See your router documentation or contact your internet service provider for instructions.

Parent topic: [Solving Network Problems](#)

Cannot Print Over a Network

If you cannot print over a network, try these solutions:

- Make sure that your product is turned on.
- Make sure you install your product's network software as described in your product documentation.
- Print a network status sheet and verify that the network settings are correct. If the network status is **Disconnected**, check any cable connections and turn your product off and then on again.
- Print a network connection report and check the codes and messages on the report to help determine the cause of the problem.
- If you are using TCP/IP, make sure the product's IP address is set correctly for your network. If your network does not assign IP addresses using DHCP, set the IP address manually.
- Make sure your computer and product are both using the same wireless network.
- If network printing is slow, print a network status sheet and check the signal strength. If it is poor, place your product closer to your router or access point. Avoid placing your product near a microwave oven, cordless phone, or large metal object, such as a filing cabinet.

Note: If you are using a 5 GHz wireless router, set the router to operate in dual band (2.4 GHz and 5 GHz) mode. If your router uses a single network name (SSID) for both the 2.4 GHz and 5 GHz band, give each band its own network name (SSID) instead, such as Home Network 2.4 GHz and Home Network 5 GHz. See your router documentation or contact your internet service provider for instructions.

- Try restarting your router following the instructions in your router documentation.

Note: If you are reading these instructions online, you will lose your Internet connection when you restart your router.

- Check if there are any paused print jobs.
- Make sure your printer is selected as the default printer.

- Check if the selected printer port is correct.
- Check to see if your wireless router or access point has an enabled Privacy Separator function that is preventing printing from a device over the network. See your router or access point documentation for instructions on disabling the Privacy Separator function.
- If you are connecting the product via Wi-Fi Protected Setup (WPS) and the Wi-Fi icon on your product's LCD screen is not lit, make sure you select one of the WPS options from the product control panel within 2 minutes of pressing the WPS button on your router.
- Check your wired LAN router or access point to see if the LED for the port to which your product is connected is on or flashing. If the link LED is off, try the following:
 - Make sure the Ethernet cable is securely connected to your product and to your router, access point, switch, or hub.
 - Try connecting your product to a different port or a different router, access point, switch, or hub.
 - Try connecting with a different Ethernet cable.
 - Try printing to your product from another computer on the network.

Note: If you are using a 5 GHz wireless router, set the router to operate in dual band (2.4 GHz and 5 GHz) mode. If your router uses a single network name (SSID) for both the 2.4 GHz and 5 GHz band, give each band its own network name (SSID) instead, such as Home Network 2.4 GHz and Home Network 5 GHz. See your router documentation or contact your internet service provider for instructions.

- If you are connecting the product via EpsonNet Setup and the Wi-Fi icon does not appear lit on the LCD screen, make sure your product software was installed correctly. If necessary, reinstall your software.

Parent topic: [Solving Network Problems](#)

Related tasks

[Printing a Network Status Sheet](#)

[Printing a Network Connection Report](#)

Solving Printing Problems

Check these sections if you have problems printing with your product.

[Nothing Prints](#)

[Print Head Moves But Nothing Prints](#)

Parent topic: [Solving Problems](#)

Nothing Prints

If you have sent a print job and nothing prints, try these solutions:

- Make sure your printer is turned on.
- Make sure there are no error messages on the product's LCD screen.
- If you have **Print Preview** enabled in your printer driver, the preview appears after you click Print but before printing starts. Disable this setting if you want printing to start immediately.
- Make sure any interface cables are connected securely at both ends. If you have a spare cable, try connecting with the spare cable.
- Check the model and specifications of the interface cable to see if the cable is appropriate for your computer and printer.
- If you connected your printer to a USB hub, make sure it is a first-tier hub. If it still does not print, connect your printer directly to your computer instead of the hub.
- Make sure the USB hub is recognized correctly on the computer. Disconnect all USB hubs from the computer and connect the printer directly to the computer's USB port.
- Make sure the USB cable length does not exceed 10 feet (3 m).

Parent topic: [Solving Printing Problems](#)

Related references

[Interface Specifications](#)

Print Head Moves But Nothing Prints

If the print head is moving and nothing prints, try these solutions:

- Print a nozzle check pattern. If the pattern does not print correctly, clean the print head again. (If the printer has not been used for a long time the nozzles may be clogged.)
- If you see a message about motor self adjustment on the product's LCD screen, the printer is adjusting its internal motor. Wait a few moments for the message to disappear and do not turn off the printer.

Parent topic: [Solving Printing Problems](#)

Related concepts

[Print Head Nozzle Check](#)

[Print Head Cleaning](#)

Solving Paper Problems

Check these sections if you have problems using paper with your product.

[Paper Feeding Problems](#)

[Paper Cutting/Ejection Problems](#)

[Paper is Creased](#)

[Roll Paper Jam Problems](#)

[Cut Sheet Paper Jam Problems](#)

Parent topic: [Solving Problems](#)

Paper Feeding Problems

If you have problems feeding paper, try these solutions:

- Make sure paper is loaded in the correct orientation. Load cut sheets vertically (short edge first).
- For best results, follow these guidelines:
 - Use new, smooth, high-quality paper that is not damp, curled, creased, old, too thin, or too thick.
 - Follow any special loading instructions that came with the paper.
- If roll paper does not feed, cut the end straight across and uncurl it by rolling it backward, if necessary. Then reload the paper.
- Make sure there are no gaps between the roll paper and the paper stops on the spindle.
- If wrinkles appear on roll paper, adjust the **Back Tension** setting.
- If you cannot insert paper easily into the paper feed slot, make sure the paper is perfectly flat and not curled.
- Do not load more than one piece of cut sheet paper.
- Make sure your paper meets the specifications for your product.
- Make sure you selected the **Media Type** setting in the printer driver that matches the paper you loaded in the product.
- Make sure that paper is not jammed inside the product.
- Make sure you are using the product at the proper room temperature.

Parent topic: [Solving Paper Problems](#)

Related references

[Paper Specifications](#)

[Paper Setting Menu](#)

Related tasks

[Selecting Basic Print Settings - Mac](#)

[Selecting Basic Print Settings - Windows](#)

[Loading Roll Paper](#)

[Loading Single Cut Sheets](#)

Related topics

[Cutting Roll Paper](#)

Paper Cutting/Ejection Problems

If your printout does not cut cleanly or does not eject into the paper basket, try these solutions:

- Replace the cutter.
- Manually cut the paper after the image is printed. Make sure the **Auto Cut** setting is turned off.
- Use your hands to lightly press the paper into the paper basket as it is ejected from the printer.
- If the paper creases as it ejects into the paper basket, close the paper basket and support the printout with your hands before it touches the floor.

Parent topic: [Solving Paper Problems](#)

Paper is Creased

If the paper is creased when it exits the printer, try these solutions:

- Make sure you are printing at normal room temperatures (59 to 77° F [15 to 25° C])
- Make sure the paper stops are flush with the edges of the paper with no gap.
- Perform an Easy Adjustment.
- Adjust the **Back Tension** setting to **High** or **Extra High**.

Parent topic: [Solving Paper Problems](#)

Roll Paper Jam Problems

If roll paper has jammed in the printer, follow the steps here to clear the jam.

1. Open the cut sheet cover and roll paper cover.

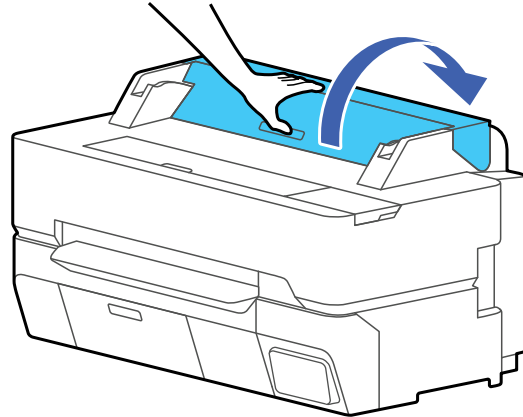

2. Cut the paper above the paper feeder.

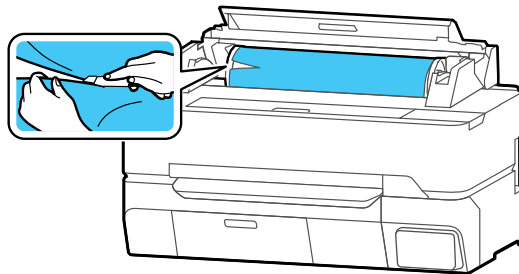

3. Close the roll paper cover and the cut sheet cover.

4. Remove the jammed paper from the front of the product.

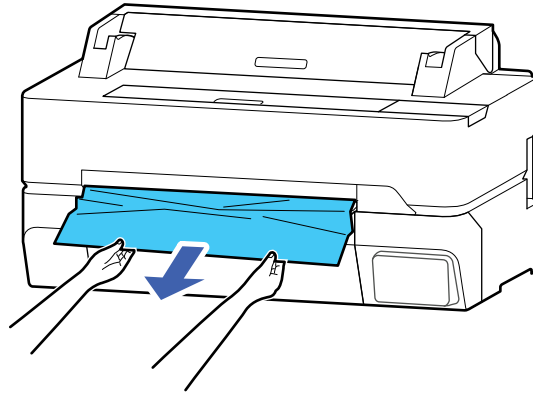

5. Open the front cover and remove any other jammed paper as necessary.

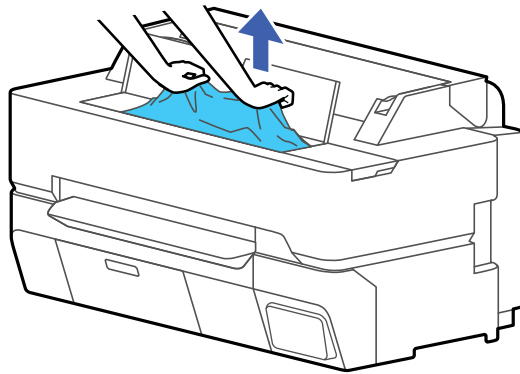

Caution: Do not touch the print head.

6. Close the front cover.
7. Turn the printer off, wait a moment, and then turn it back on.
8. Cut the edge of the roll paper straight horizontally and reload the roll paper.

Note: Make sure to cut off any jagged or folded sections of paper.

Parent topic: [Solving Paper Problems](#)

Related tasks

[Loading Roll Paper](#)

Cut Sheet Paper Jam Problems

If cut sheet paper has jammed in the product, follow the steps here to clear the jam.

1. Remove any jammed paper from the front of the product.

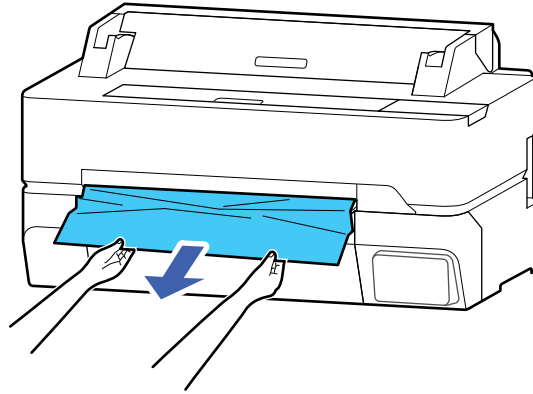

2. Open the front cover.

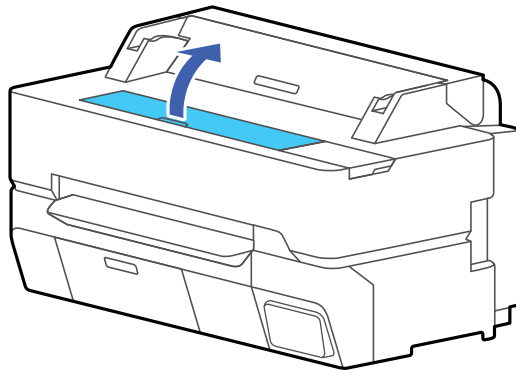

3. Remove any other jammed paper as necessary.

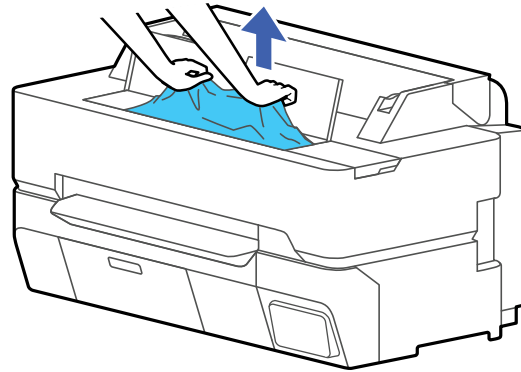

Caution: Do not touch the print head.

4. Close the front cover.
5. Turn the printer off, wait a moment, and then turn it back on.
6. Reload a cut sheet.

Parent topic: [Solving Paper Problems](#)

Related tasks

[Loading Single Cut Sheets](#)

Solving Print Quality Problems

Check these sections if you have problems with print quality.

[Overall Print Quality is Poor](#)

[Lines Are Misaligned](#)

[Prints are Scuffed or Smearred](#)

[Prints are Not Positioned Properly](#)

Parent topic: [Solving Problems](#)

Overall Print Quality is Poor

If you notice that your print quality is uneven, too light, too dark, or there are lines in the print (banding), try these solutions:

- Run a nozzle check to see if any of the print head nozzles are clogged. Then clean the print head, if necessary. If nozzles are still clogged after cleaning three times, perform a Powerful Cleaning.
- Check the **Color Density** setting.
- Perform an Easy Adjustment, or run a manual Print Head Alignment and Paper Feed Adjustment.
- Make sure your paper meets the specifications for your product.
- Make sure the paper is not wrinkled, folded, or bent.
- Make sure your ink cartridges have not expired. For best results, use ink cartridges before the expiration date printed on the package (within six months of installation in the printer). Replace expired cartridges with new ones.
- Shake the cartridges before installing them in the printer.
- Remove and shake the cartridges every three months.
- Make sure you selected the correct **Media Type** setting in the printer driver that matches the paper loaded in the printer.
- Compare the print result with the image on your computer screen. Since monitors and printers produce colors differently, printed colors and screen colors do not always look the same.
- Make sure that all printer covers are closed during printing.
- Keep all printer covers closed unless you are loading or unloading media to prevent dust from accumulating inside the printer.
- Check the ink levels on the LCD screen. Replace any cartridges that are low on ink.
- Enable color management in the software application or in the printer driver.
- If you are using non-Epson media, make sure you create a custom paper configuration for the media.
- Check the quality setting that you selected in the printer driver. Using a faster printing method may decrease the overall print quality.

Parent topic: [Solving Print Quality Problems](#)

Related concepts

[Print Head Nozzle Check](#)

[Print Head Cleaning](#)

Related tasks

[Removing and Installing Ink Cartridges](#)

[Managing Color - Mac](#)

[Creating Custom Paper Configurations](#)

[Adjusting Paper Feed Using the Product Control Panel](#)

[Aligning the Print Head Using the Product Control Panel](#)

[Selecting Basic Print Settings - Windows](#)

[Selecting Basic Print Settings - Mac](#)

Lines Are Misaligned

You may see vertical lines in the (bi-directional) print output. If this occurs, try these solutions:

- Perform a Print Head Alignment.
- If the problem persists after Print Head Alignment, uncheck the **Simple Settings** checkbox in the printer driver, select **Level - Max Quality**, and clear the **High Speed** checkbox. Then try printing again.
- Make sure you selected the correct **Media Type** setting in the printer driver that matches the paper loaded in the printer.

Parent topic: [Solving Print Quality Problems](#)

Related tasks

[Aligning the Print Head Using the Product Control Panel](#)

[Selecting Basic Print Settings - Mac](#)

[Selecting Basic Print Settings - Windows](#)

Prints are Scuffed or Smearred

If your prints are scuffed or smeared, try these solutions:

- Make sure your paper meets the specifications for your product.
- Make sure you selected the correct **Media Type** setting in the printer driver that matches the paper loaded in the printer.
- Do not use paper with folds or creases and always use new media.
- If you are using cut sheet paper, check that changes in humidity and temperature have not made the paper wavy or curled up on the edges. Flatten the paper before loading it or use new paper.
- If the surface of the paper is scuffed, select a wider **Platen Gap** setting.

- If you are printing on thick paper, make sure the **Thick Paper** setting is enabled in the **Printer Settings** menu.
- If the bottom edge is scuffed, try widening the bottom margin.
- If ink is smeared on your prints, clean the rollers. Load blank paper and perform a paper guide cleaning.
- If you are using non-Epson media, make sure you create a custom paper configuration for the media and run **Easy Adjustment**.
- Depending on the print density and type of paper you are using, the ink may take a while to dry. Do not stack the prints until the ink is completely dry. You can adjust the drying time in the **Printer Settings** menu.
- Adjust the ink density in the printer driver settings and on the control panel for custom paper configuration settings.
- If the back of your prints are smeared with ink, clean the platen and replace any borderless printing pads as necessary.

Parent topic: [Solving Print Quality Problems](#)

Related references

[Paper Setting Menu](#)

[Printer Settings Menu](#)

[Paper Specifications](#)

Related tasks

[Selecting Basic Print Settings - Mac](#)

[Selecting Basic Print Settings - Windows](#)

[Creating Custom Paper Configurations](#)

[Cleaning the Roll Paper Feeder](#)

[Cleaning the Platen and Borderless Pad Edges](#)

[Replacing the Borderless Pads](#)

Prints are Not Positioned Properly

If your prints are not positioned properly on the media, try these solutions:

- Make sure your print settings in the control panel and the printer driver match.
- Make sure the **Document Size** or **Paper Size** setting in the printer driver matches the paper loaded in the product.

- Check for paper skew errors on the LCD screen. Make sure the **Detect Paper Meandering** setting is set to **On**.
- Margin settings made in the printer driver have priority over margin settings made in the control panel.

Parent topic: [Solving Print Quality Problems](#)

Related references

[Printer Settings Menu](#)

Related tasks

[Selecting Basic Print Settings - Mac](#)

[Selecting Basic Print Settings - Windows](#)

Cannot Make Enlarged Copies from Scanner

If you cannot make enlarged copies from a scanner connected to your printer, try these solutions:

- Make sure all cables are securely connected and the scanner is turned on.
- Make sure the scanner connected to the printer is compatible. Visit the Epson website for the most updated list of supported scanners.

Parent topic: [Solving Problems](#)

Related tasks

[Connecting a Scanner to Your Printer](#)

Uninstall Your Product Software

If you have a problem that requires you to uninstall and re-install your software, follow the instructions for your operating system.

[Uninstalling Product Software - Windows](#)

[Uninstalling Product Software - Mac](#)

Parent topic: [Solving Problems](#)

Uninstalling Product Software - Windows

You can uninstall and then re-install your printer software to solve certain problems.

1. Turn off the product.
2. Disconnect any interface cables.

3. Do one of the following:

- **Windows 10:** Right-click  and select **Control Panel > Programs > Programs and Features**. Select the uninstall option for your Epson product, then select **Uninstall/Change**.

Note: If you see a **User Account Control** window, click **Yes** or **Continue**.

Select your product again, if necessary, then select **OK**, and click **Yes** to confirm the uninstallation.

- **Windows 8.x:** Navigate to the **Apps** screen and select **Control Panel > Programs > Programs and Features**. Select the uninstall option for your Epson product, then select **Uninstall/Change**.

Note: If you see a **User Account Control** window, click **Yes** or **Continue**.

Select your product again, if necessary, then select **OK**, and click **Yes** to confirm the uninstallation.

- **Windows (other versions):** Click  or **Start**, and select **All Programs** or **Programs**. Select **Epson**, select your product, then click **EPSON Printer Software Uninstall**.

Note: If you see a **User Account Control** window, click **Yes** or **Continue**.

In the next window, select your product and click **OK**. Then follow any on-screen instructions.

4. Restart your computer, then re-install your software.

Note: If re-installing your product software does not solve a problem, contact Epson support.

Parent topic: [Uninstall Your Product Software](#)

Related references

[Where to Get Help](#)

Uninstalling Product Software - Mac

In most cases, you do not need to uninstall your product software before re-installing it. However, you can download the Uninstaller utility from the Epson support website to uninstall your product software as described here.

Note: If re-installing your product software does not solve a problem, contact Epson support.

1. To download the Uninstaller utility, visit epson.com/support (U.S.), epson.ca/support (Canada), or epson.com.jm/support (Caribbean) and select your product.
2. Click **Downloads**.
3. Select your operating system, click **Utilities**, locate the Uninstaller utility, and click **Download**. (If you do not see an Uninstaller utility, search for "Uninstaller" using the site search field.)
4. Run the file you downloaded.
5. Double-click the **Uninstaller** icon.
6. In the Epson Uninstaller screen, select the checkbox for each software program you want to uninstall.
7. Click **Uninstall**.
8. Follow the on-screen instructions to uninstall the software.
9. Reinstall your product software.

Note: If you uninstall the printer driver and your product name remains in the **Print & Fax**, **Print & Scan**, or **Printers & Scanners** window, select your product name and click the – (remove) icon to remove it.

Parent topic: [Uninstall Your Product Software](#)

Related references

[Where to Get Help](#)

Where to Get Help

Epson provides technical support and information on the installation, configuration, and operation of professional printing products through the Epson Preferred Limited Warranty Plan. Dial (888) 377-6611, 6 AM to 6 PM, Pacific Time, Monday through Friday. Days and hours of support are subject to change without notice.

Note: If you experience difficulty with the toll-free number, call (562) 276-1305 (U.S.).

Before you call, make sure you have your printer serial number and proof of purchase.

Visit epson.com/support (U.S.) or epson.ca/support (Canada) and select your product for solutions to common problems. You can download drivers, firmware, and documentation, get FAQs and troubleshooting advice, or e-mail Epson with your questions.

Note: For help using any other software on your system, see the documentation for that software for technical support information.

Purchase Supplies and Accessories

You can purchase genuine Epson ink, paper, and accessories from an Epson authorized reseller. To find the nearest reseller, visit proimaging.epson.com (U.S.) or proimaging.epson.ca (Canada), select your product series and product, and click the **Where to Buy** button. Or call 800-GO-EPSON (800-463-7766) in the U.S. or 800-807-7766 in Canada.

Parent topic: [Solving Problems](#)

Technical Specifications

These sections list the technical specifications for your product.

Note: Epson offers a recycling program for end of life Epson products. Please go to [this site](#) (U.S) or [this site](#) (Canada) for information on how to return your Epson products for proper disposal.

[Windows System Requirements](#)

[Mac System Requirements](#)

[Paper Specifications](#)

[Printable Area Specifications](#)

[Ink Cartridge Specifications](#)

[Dimension Specifications](#)

[Electrical Specifications](#)

[Environmental Specifications](#)

[Interface Specifications](#)

[Network Interface Specifications](#)

[Safety and Approvals Specifications](#)

Windows System Requirements

To use your product and its software, your computer should meet these requirements.

Microsoft Windows OS version (32- and 64-bit compatible)	Windows 10, Windows 8.x, Windows 7, Windows Vista, Windows Server 2016, Windows Server 2012 R2, Windows Server 2012, Windows Server 2008 R2, Windows Server 2008, Windows Server 2003 R2, Windows Server 2003 SP2 or later
CPU	Core 2 Duo 3.05 GHz or better
Memory	1GB or more
Hard disk space available	32GB or more
Display resolution	WXGA (1280 × 800) or higher

Note: For the latest product software available for your operating system, visit the Epson support site at epson.com/support (U.S.), epson.ca/support (Canada), or epson.com.jm/support (Caribbean), select your product, and select **Downloads**.

Parent topic: [Technical Specifications](#)

Mac System Requirements

To use your product and its software, your Mac should meet these requirements.

OS X version	Mac OS X 10.6.8 through macOS 10.15.x
CPU	Core 2 Duo 3.05 GHz or better
Memory	4GB or more
Hard disk space available	32GB or more
Display resolution	WXGA+ (1440 × 900) or higher

Note: For the latest product software available for your operating system, visit the Epson support site at epson.com/support (U.S.), epson.ca/support (Canada), or epson.com.jm/support (Caribbean), select your product, and select **Downloads**.

Parent topic: [Technical Specifications](#)

Paper Specifications

Note: Since the quality of any particular brand or type of paper may be changed by the manufacturer at any time, Epson cannot guarantee the quality of any non-Epson brand or type of paper. Always test a sample of paper stock before purchasing large quantities or printing large jobs.

Roll paper

Core size	2 inches (51 mm) or 3 inches (76.2 mm)
Outer diameter	Up to 6.7 inches (170 mm)
Width	SureColor T3475: 10 to 24 inches (254 to 610 mm) SureColor T5475: 10 to 36 inches (254 to 914 mm)

Thickness 0.003 to 0.011 inch (0.08 to 0.3 mm)

Weight Up to 26.4 lbs (12 kg)

Cut sheet paper (1 sheet)

Width **SureColor T3475:** 8.26 to 24 inches (210 to 610 mm)

SureColor T5475: 8.26 to 36 inches (210 to 914 mm)

Length 11 to 62.2 inches (279.4 to 1580 mm)

Thickness 0.003 to 0.011 inch (0.08 to 0.3 mm)

Parent topic: [Technical Specifications](#)

Printable Area Specifications

Roll paper

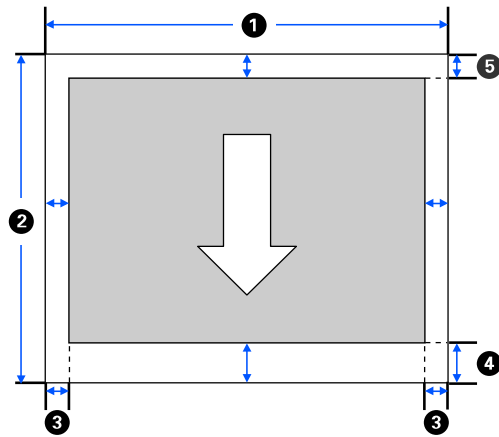

Note: Margins may change depending on the **Top/Bottom Margins** setting that you select. The numbers below are the standard settings.

- 1 Printable width:
SureColor T3475: 10 to 24 inches (254 to 610 mm)
SureColor T5475: 10 to 36 inches (254 to 914 mm)
- 2 Printable length: 11 to 708.66 inches (279.4 to 18000 mm)
- 3 Left/right margin: 0.12 inch (3 mm) minimum (0 inches [0 mm] with borderless printing)
- 4 Bottom margin: 0.12 to 1.38 inches (3 to 35 mm)
- 5 Top margin: 0.12 to 0.59 inches (3 to 15 mm)

Cut sheet (1 sheet)

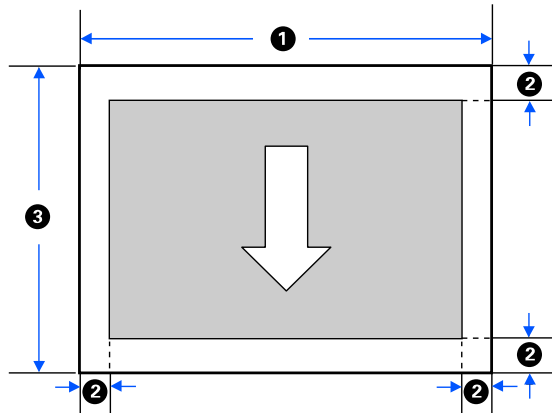

- 1 Printable width:
SureColor T3475: 8.27 to 24 inches (210 to 610 mm)
SureColor T5475: 8.27 to 36 inches (210 to 914 mm)
 - 2 Left/right/bottom margin: 0.12 inch (3 mm) (left/right margins will be 0 inches [0 mm] with borderless printing)
 Top margin: 0.78 inch (20 mm)
- Note:** Top and bottom margins vary depending on print quality settings.
- 3 Printable length: 11 to 50.87 inches (279.4 to 1292 mm)

Parent topic: [Technical Specifications](#)

Ink Cartridge Specifications

Note: We recommend that you use genuine Epson cartridges and do not refill them. The use of other products may affect your print quality and could result in printer damage.

The cartridges included with the printer are designed for printer setup and not for resale. After some ink is used for charging, the rest is available for printing. Yields vary considerably based on images printed, print settings, paper type, frequency of use, and temperature. For print quality, a variable amount of ink remains in the cartridge after the "replace cartridge" indicator comes on.

Type	Epson ink cartridges
Pigment ink	Cyan, Magenta, Yellow, Black
Cartridge life	See the expiration date on the package or cartridge
Print quality guarantee	1 year after installation in the printer
Temperature	Transportation (in package): -4 to 140 °F (-20 to 60°C) Storage (in package and after installation): -4 to 104 °F (-20 to 40°C) 1 month at 104°F (40°C) Ink freezes below -4°F (-20°C) Ink thaws and is usable after 4 hours at 77°F (25°C)

Cartridge dimensions

110 ml:

Width: 0.98 inches (25 mm)

Depth: 7.87 inches (200 mm)

Height: 4.33 inches (110 mm)

350 ml:

Width: 1.57 inches (40 mm)

Depth: 7.87 inches (200 mm)

Height: 4.33 inches (110 mm)

700 ml:

Width: 1.57 inches (40 mm)

Depth: 12 inches (305 mm)

Height: 4.33 inches (110 mm)

Parent topic: [Technical Specifications](#)**Related references**[Ink Cartridge and Maintenance Box Part Numbers](#)

Dimension Specifications

SureColor T3475

Dimensions include the opened paper basket.

Height 41.73 inches (1060 mm)**Width** 42.52 inches (1080 mm)**Depth** 38.03 inches (966 mm)**Weight** Approx. 141.09 lb (64 kg)

(without ink cartridges)

SureColor T5475

Dimensions include the opened paper basket.

Height	41.73 inches (1060 mm)
Width	54.52 inches (1385 mm)
Depth	38.03 inches (966 mm)
Weight (without ink cartridges)	Approx. 167.55 lb (76 kg)

Parent topic: [Technical Specifications](#)

Electrical Specifications

Power supply rating	100 to 240 V
Rated frequency range	50/60 Hz
Rated current	2.8 A
Power consumption	SureColor T3475: <ul style="list-style-type: none">• Printing: approximately 34 W• Ready mode: approximately 13 W• Sleep mode: approximately 1.3 W• Power off mode: approximately 0.25 W SureColor T5475: <ul style="list-style-type: none">• Printing: approximately 38 W• Ready mode: approximately 13 W• Sleep mode: approximately 1.3 W• Power off mode: approximately 0.25 W

Parent topic: [Technical Specifications](#)

Environmental Specifications

Temperature	Operating: 50 to 95 °F (10 to 35 °C) Operating (recommended): 59 to 77 °F (15 to 25 °C) Storage (before unpacking): –4 to 140 °F (–20 to 60 °C) 1 month at 104 °F (40 °C) Storage (after unpacking): 14 to 104 °F (–10 to 40 °C) 1 month at 104 °F (40 °C)
Humidity (non-condensing)	Operating: 20 to 80% RH Operating (recommended): 40 to 60% RH Storage: 5 to 85% RH

Parent topic: [Technical Specifications](#)

Interface Specifications

Interface type	High-Speed USB port compatible with USB 2.0 specification (OPTION port) for scanner connection SuperSpeed USB port compatible with USB 3.0 specification (USB port) for computer connection
-----------------------	--

Parent topic: [Technical Specifications](#)

Network Interface Specifications

Wi-Fi	
Standards	IEEE802.11b/g/n
Securities	WEP (64/128bit) WPA-PSK (TKIP) WPA2-PSK (AES) (complies with WPA2 standards with support for WPA/WPA2 Personal)
Frequency range	2.4 GHz

Communication mode Infrastructure
Wi-Fi Direct (Simple AP) (not supported for IEEE802.11b)

Security Protocols

- SSL/TLS (HTTPS Server/Client, IPPS)
- IEEE802.1X
- IPsec/IP Filtering
- SMTPS (STARTTLS, SSL/TLS)
- SNMPv3

Ethernet

Standards IEEE802.3i (10BASE-T)
IEEE802.3u (100BASE-TX)
IEEE802.3ab (1000BASE-T)
IEEE802.3az (Energy Efficient Ethernet); connected device should comply with IEEE802.3az standards

Note: Use a category 5 or higher shielded twisted pair cable for all interfaces.

Parent topic: [Technical Specifications](#)

Safety and Approvals Specifications

United States Safety: UL62368-1: 2014
EMC: FCC part 15 Subpart B class B

Canada Safety: CSA C22.2 No.62368-1
ICES-003: CAN/CSA-CEI/IEC CISPR 22 Class B (ANSI C63.4-2014)

This equipment contains the following wireless module:

- Model: SureColor T3475/T5475

- Manufacturer: Epson
- Type: WLU6320-D69 (RoHS)

This product conforms to Part 15 of FCC Rules and RSS-210 of the IC Rules. Epson cannot accept responsibility for any failure to satisfy the protection requirements resulting from a non-recommended modification of the product. Operation is subject to the following two conditions: (1) this device may not cause harmful interference, and (2) this device must accept any interference received, including interference that may cause undesired operation of the device.

To prevent radio interference to the licensed service, this device is intended to be operated indoors and away from windows to provide maximum shielding. Equipment (or its transmit antenna) that is installed outdoors is subject to licensing.

This equipment complies with FCC/IC radiation exposure limits set forth for an uncontrolled environment and meets the FCC radio frequency (RF) Exposure Guidelines in Supplement C to OET65 and RSS-102 of the IC radio frequency (RF) Exposure rules. This equipment should be installed and operated so that the radiator is kept at least 7.9 inches (20 cm) or more away from a person's body (excluding extremities: hands, wrists, feet and ankles).

Notice for Argentina

Model: SureColor T3475/T5475

WLAN Module Model: WLU6320-D69 (RoHS)

Brand: EPSON

 CNC ID: C-12902

Notice for Mexico

Operation is subject to the following two conditions: (1) this device may not cause harmful interference, and (2) this device must accept any interference received, including interference that may cause undesired operation of the device.

Product Model: K331A (SureColor T3475/T5475)

WLAN Module Model: WLU6320-D69 (RoHS)

Brand: EPSON

IFT Certification Number: RCPEPWL14-0107

Notice for Paraguay

Imported by:

Fastrax, S.A.

Av. Perú esq. Río de Janeiro, Barrios Las Mercedes, Asunción, Paraguay

Imported by:

Sol Control S.R.L.

Av. Gral. Bernardino Caballero 810 esq. Celsa Speratti, Asunción, Paraguay

Notice for Peru

Product Model: SureColor T3475/T5475 (K331A)

Brand: EPSON

This product uses the following WLAN module:

WLAN Module Model: WLU6320-D69 (RoHS)

FCC ID: BKMFBWLU6320

Product Manufacturer: Seiko Epson Corporation

Address: 3-3-5 Owa Suwa-shi, Nagano-Ken 392-8502, Japan

Parent topic: [Technical Specifications](#)

Notices

Check these sections for important notices about your product.

Note: Epson offers a recycling program for end of life Epson products. Please go to [this site](#) (U.S) or [this site](#) (Canada) for information on how to return your Epson products for proper disposal.

[Important Safety Instructions](#)

[FCC Compliance Statement](#)

[Binding Arbitration and Class Waiver](#)

[Trademarks](#)

[Copyright Notice](#)

Important Safety Instructions

Before using your Epson product, read and follow these safety instructions.

[General Product Safety Instructions](#)

[Ink Cartridge Safety Instructions](#)

[LCD Screen Safety Instructions](#)

[Wireless Connection Safety Instructions](#)

Parent topic: [Notices](#)

General Product Safety Instructions

- Be sure to follow all warnings and instructions marked on the product.
- Use only the type of power source indicated on the product's label.
- Use only the power cord that comes with the product. Use of another cord may cause fires or shock. Do not use the cord with any other equipment.
- Place the product near a wall outlet where the plug can be easily unplugged.
- Connect your product to a properly grounded power outlet. Avoid plugging the product into an outlet on the same circuit as a photo copier or air control system that regularly switches on and off, or on an outlet controlled by a wall switch or timer.
- Make sure the plug is fully inserted into the outlet.

- Do not let the power cord become damaged or frayed. Place it to avoid abrasions, cuts, fraying, crimping, and kinking. Do not place objects on top of it and do not allow it to be stepped on or run over. Be careful to keep the cord straight at each end.
- If you use an extension cord with the product, make sure the total ampere rating of the devices plugged into the extension cord does not exceed the cord's ampere rating. Also, make sure the total ampere rating of all devices plugged into the wall outlet does not exceed the wall outlet's ampere rating.
- If damage occurs to the plug, replace the cord set or consult a qualified electrician. If there are fuses in the plug, make sure you replace them with fuses of the correct size and rating.
- Always turn off the product using the power button, and wait until the power light stops flashing before unplugging the product or cutting off power to the electrical outlet.
- If you will not be using the product for a long period, unplug the power cord from the electrical outlet.
- Place the product on a flat, stable surface that extends beyond its base in all directions. It will not operate properly if it is tilted or at an angle.
- Avoid locations that are subject to rapid changes in heat or humidity, shocks or vibrations, or dust.
- Do not place or store the product outdoors.
- Do not place the product near excessive heat sources or in direct sunlight.
- Leave enough room around the product for sufficient ventilation. Do not block or cover openings in the cabinet or insert objects through the slots.
- Keep the product away from potential sources of electromagnetic interference, such as loudspeakers or the base units of cordless telephones.
- When connecting the product to a computer or other device with a cable, ensure the correct orientation of the connectors. Each connector has only one correct orientation. Inserting a connector in the wrong orientation may damage both devices connected by the cable.
- Do not put your hands inside the product or touch the ink cartridges while printing.
- Do not move the print head by hand; this may damage the product.
- Do not spill liquid on the product or use the product with wet hands.
- Do not insert or unplug the plug with wet hands.
- Do not use aerosol products that contain flammable gases inside or around the product. Doing so may cause fire.
- Except as specifically explained in your documentation, do not attempt to service the product yourself.

- Unplug the product and refer servicing to qualified service personnel under the following conditions: if the power cord or plug is damaged; if liquid has entered the product; if the product has been dropped or the cabinet damaged; if the product does not operate normally or exhibits a distinct change in performance. Adjust only those controls that are covered by the operating instructions.
- Leave the ink cartridges installed. Removing the cartridges can dehydrate the print head and may prevent the product from printing.
- Before storing the product, make sure the print head is positioned at the far right.
- When storing or transporting the product, do not tilt it, stand it on its side, or turn it upside down; otherwise ink may leak.

Note: The lithium batteries in this product contain Perchlorate Material - special handling may apply. [Click here](#) for details.

Parent topic: [Important Safety Instructions](#)

Ink Cartridge Safety Instructions

- Keep ink cartridges out of the reach of children and do not drink the ink.
- Be careful when you handle used ink cartridges; there may be ink remaining around the ink supply port.
- If ink gets on your skin, wash it off with soap and water. If it gets in your eyes, flush them immediately with water.
- Do not put your hand inside the product or touch any cartridges during printing.
- Install a new ink cartridge immediately after removing an expended one. Leaving cartridges uninstalled can dry out the print head and may prevent the product from printing.
- Install ink cartridges in all the ink cartridge slots. You cannot print if any of the slots are empty.
- Dried ink on the supply port may cause ink leaks when the cartridge is reinserted and used. Wipe off any excess ink before reinserting.
- Do not insert or remove replacement cartridges during printing.
- Do not remove the transparent seal from the ink supply port. This may cause the cartridge to become unusable.
- The green IC chip on this ink cartridge retains a variety of cartridge-related information, such as the ink cartridge status, so that the cartridge may be removed and reinserted freely. Do not touch the green IC chip on the side of the cartridge. This may prevent normal operation and printing.

- If you remove an ink cartridge for later use, protect the ink supply area from dirt and dust and store it in the same environment as the product. Note that there is a valve in the ink supply port, making covers or plugs unnecessary, but care is needed to prevent the ink from staining items that the cartridge touches. Do not touch the ink cartridge ink supply port or surrounding area.
- To ensure print quality, use an ink cartridge before the date printed on its package.
- Do not dismantle or alter an ink cartridge. This could damage the print head and may prevent the product from printing.
- Do not drop cartridges or bump them against hard objects; otherwise, the ink may leak.
- Store ink cartridges at room temperature in a location that is not exposed to direct sunlight.
- After bringing an ink cartridge inside from a cold storage site, allow it to warm up at room temperature for at least four hours before using it.

Parent topic: [Important Safety Instructions](#)

LCD Screen Safety Instructions

- Use only a dry, soft cloth to clean the LCD screen. Do not use liquid or chemical cleansers.
- If the LCD screen is damaged, contact Epson. If the liquid crystal solution gets on your hands, wash them thoroughly with soap and water. If the liquid crystal solution gets into your eyes, flush them immediately with water. If discomfort or vision problems remain after a thorough flushing, see a doctor immediately.
- Do not press too hard on the LCD screen or subject it to heavy impacts.
- Do not use a pointy or sharp object, such as a pen or your fingernail, to operate the LCD screen.
- If the LCD screen chips or cracks, do not touch or attempt to remove the broken pieces; contact Epson for support.
- Do not subject your product to sudden changes in temperature or humidity; this may cause condensation to develop inside the LCD screen and degrade its performance.

Parent topic: [Important Safety Instructions](#)

Wireless Connection Safety Instructions

Radio waves from this product may adversely affect the operation of medical equipment or automatically controlled devices, such as pacemakers, automatic doors or fire alarms. When using this product near such devices or inside a medical facility, follow the directions from authorized staff members at the facility, and follow all posted warnings and directions on the device to avoid causing an accident.

Parent topic: [Important Safety Instructions](#)

FCC Compliance Statement

For United States Users

This equipment has been tested and found to comply with the limits for a Class B digital device, pursuant to Part 15 of the FCC Rules. These limits are designed to provide reasonable protection against harmful interference in a residential installation. This equipment generates, uses, and can radiate radio frequency energy and, if not installed and used in accordance with the instructions, may cause harmful interference to radio or television reception. However, there is no guarantee that interference will not occur in a particular installation. If this equipment does cause interference to radio and television reception, which can be determined by turning the equipment off and on, the user is encouraged to try to correct the interference by one or more of the following measures:

- Reorient or relocate the receiving antenna.
- Increase the separation between the equipment and receiver.
- Connect the equipment into an outlet on a circuit different from that to which the receiver is connected.
- Consult the dealer or an experienced radio/TV technician for help.

WARNING

The connection of a non-shielded equipment interface cable to this equipment will invalidate the FCC Certification or Declaration of this device and may cause interference levels which exceed the limits established by the FCC for this equipment. It is the responsibility of the user to obtain and use a shielded equipment interface cable with this device. If this equipment has more than one interface connector, do not leave cables connected to unused interfaces. Changes or modifications not expressly approved by the manufacturer could void the user's authority to operate the equipment.

For Canadian Users

CAN ICES-3(B)/NMB-3(B)

Parent topic: [Notices](#)

Binding Arbitration and Class Waiver

1. DISPUTES, BINDING INDIVIDUAL ARBITRATION, AND WAIVER OF CLASS ACTIONS AND CLASS ARBITRATIONS

1.1 **Disputes.** The terms of this Section 1 shall apply to all Disputes between you and Epson. The term "Dispute" is meant to have the broadest meaning permissible under law and includes any dispute, claim, controversy or action between you and Epson arising out of or relating to this Agreement, Epson branded products (hardware and including any related software), or other transaction involving you and

Epson, whether in contract, warranty, misrepresentation, fraud, tort, intentional tort, statute, regulation, ordinance, or any other legal or equitable basis. "DISPUTE" DOES NOT INCLUDE IP CLAIMS, or more specifically, a claim or cause of action for (a) trademark infringement or dilution, (b) patent infringement, (c) copyright infringement or misuse, or (d) trade secret misappropriation (an "IP Claim"). You and Epson also agree, notwithstanding Section 1.6, that a court, not an arbitrator, may decide if a claim or cause of action is for an IP Claim.

1.2 Binding Arbitration. You and Epson agree that all Disputes shall be resolved by binding arbitration according to this Agreement. **ARBITRATION MEANS THAT YOU WAIVE YOUR RIGHT TO A JUDGE OR JURY IN A COURT PROCEEDING AND YOUR GROUNDS FOR APPEAL ARE LIMITED.**

Pursuant to this Agreement, binding arbitration shall be administered by JAMS, a nationally recognized arbitration authority, pursuant to its code of procedures then in effect for consumer related disputes, but excluding any rules that permit joinder or class actions in arbitration (for more detail on procedure, see Section 1.6 below). You and Epson understand and agree that (a) the Federal Arbitration Act (9 U.S.C. §1, et seq.) governs the interpretation and enforcement of this Section 1, (b) this Agreement memorializes a transaction in interstate commerce, and (c) this Section 1 shall survive termination of this Agreement.

1.3 Pre-Arbitration Steps and Notice. Before submitting a claim for arbitration, you and Epson agree to try, for sixty (60) days, to resolve any Dispute informally. If Epson and you do not reach an agreement to resolve the Dispute within the sixty (60) days, you or Epson may commence an arbitration. Notice to Epson must be addressed to: Epson America, Inc., ATTN: Legal Department, 3840 Kilroy Airport Way, Long Beach, CA 90806 (the "Epson Address"). The Dispute Notice to you will be sent to the most recent address Epson has in its records for you. For this reason, it is important to notify us if your address changes by emailing us at EAlegal@ea.epson.com or writing us at the Epson Address above. Notice of the Dispute shall include the sender's name, address and contact information, the facts giving rise to the Dispute, and the relief requested (the "Dispute Notice"). Following receipt of the Dispute Notice, Epson and you agree to act in good faith to resolve the Dispute before commencing arbitration.

1.4 Small Claims Court. Notwithstanding the foregoing, you may bring an individual action in the small claims court of your state or municipality if the action is within that court's jurisdiction and is pending only in that court.

1.5 WAIVER OF CLASS ACTIONS AND CLASS ARBITRATIONS. YOU AND EPSON AGREE THAT EACH PARTY MAY BRING DISPUTES AGAINST THE OTHER PARTY ONLY IN AN INDIVIDUAL CAPACITY, AND NOT AS A PLAINTIFF OR CLASS MEMBER IN ANY CLASS OR REPRESENTATIVE PROCEEDING, INCLUDING WITHOUT LIMITATION FEDERAL OR STATE CLASS ACTIONS, OR CLASS ARBITRATIONS. CLASS ACTION LAWSUITS, CLASS-WIDE ARBITRATIONS, PRIVATE ATTORNEY-GENERAL ACTIONS, AND ANY OTHER PROCEEDING WHERE SOMEONE ACTS IN A REPRESENTATIVE CAPACITY ARE NOT ALLOWED. ACCORDINGLY, UNDER THE ARBITRATION PROCEDURES OUTLINED IN THIS SECTION, AN ARBITRATOR SHALL NOT COMBINE OR CONSOLIDATE MORE THAN ONE PARTY'S CLAIMS

WITHOUT THE WRITTEN CONSENT OF ALL AFFECTED PARTIES TO AN ARBITRATION PROCEEDING.

1.6 Arbitration Procedure. If you or Epson commences arbitration, the arbitration shall be governed by the rules of JAMS that are in effect when the arbitration is filed, excluding any rules that permit arbitration on a class or representative basis (the "JAMS Rules"), available at <http://www.jamsadr.com> or by calling 1-800-352-5267, and under the rules set forth in this Agreement. All Disputes shall be resolved by a single neutral arbitrator, and both parties shall have a reasonable opportunity to participate in the selection of the arbitrator. The arbitrator is bound by the terms of this Agreement. The arbitrator, and not any federal, state or local court or agency, shall have exclusive authority to resolve all disputes arising out of or relating to the interpretation, applicability, enforceability or formation of this Agreement, including any claim that all or any part of this Agreement is void or voidable. Notwithstanding this broad delegation of authority to the arbitrator, a court may determine the limited question of whether a claim or cause of action is for an IP Claim, which is excluded from the definition of "Disputes" in Section 1.1 above. The arbitrator shall be empowered to grant whatever relief would be available in a court under law or in equity. The arbitrator may award you the same damages as a court could, and may award declaratory or injunctive relief only in favor of the individual party seeking relief and only to the extent necessary to provide relief warranted by that party's individual claim. In some instances, the costs of arbitration can exceed the costs of litigation and the right to discovery may be more limited in arbitration than in court. The arbitrator's award is binding and may be entered as a judgment in any court of competent jurisdiction.

You may choose to engage in arbitration hearings by telephone. Arbitration hearings not conducted by telephone shall take place in a location reasonably accessible from your primary residence, or in Orange County, California, at your option.

a) Initiation of Arbitration Proceeding. If either you or Epson decides to arbitrate a Dispute, both parties agree to the following procedure:

(i) Write a Demand for Arbitration. The demand must include a description of the Dispute and the amount of damages sought to be recovered. You can find a copy of a Demand for Arbitration at <http://www.jamsadr.com> ("Demand for Arbitration").

(ii) Send three copies of the Demand for Arbitration, plus the appropriate filing fee, to: JAMS, 500 North State College Blvd., Suite 600 Orange, CA 92868, U.S.A.

(iii) Send one copy of the Demand for Arbitration to the other party (same address as the Dispute Notice), or as otherwise agreed by the parties.

b) Hearing Format. During the arbitration, the amount of any settlement offer made shall not be disclosed to the arbitrator until after the arbitrator determines the amount, if any, to which you or Epson is entitled. The discovery or exchange of non-privileged information relevant to the Dispute may be allowed during the arbitration.

c) Arbitration Fees. Epson shall pay, or (if applicable) reimburse you for, all JAMS filings and arbitrator fees for any arbitration commenced (by you or Epson) pursuant to provisions of this Agreement.

d) Award in Your Favor. For Disputes in which you or Epson seeks \$75,000 or less in damages exclusive of attorney's fees and costs, if the arbitrator's decision results in an award to you in an amount greater than Epson's last written offer, if any, to settle the Dispute, Epson will: (i) pay you \$1,000 or the amount of the award, whichever is greater; (ii) pay you twice the amount of your reasonable attorney's fees, if any; and (iii) reimburse you for any expenses (including expert witness fees and costs) that your attorney reasonably accrues for investigating, preparing, and pursuing the Dispute in arbitration. Except as agreed upon by you and Epson in writing, the arbitrator shall determine the amount of fees, costs, and expenses to be paid by Epson pursuant to this Section 1.6d).

e) Attorney's Fees. Epson will not seek its attorney's fees and expenses for any arbitration commenced involving a Dispute under this Agreement. Your right to attorney's fees and expenses under Section 1.6d) above does not limit your rights to attorney's fees and expenses under applicable law; notwithstanding the foregoing, the arbitrator may not award duplicative awards of attorney's fees and expenses.

1.7 Opt-out. You may elect to opt-out (exclude yourself) from the final, binding, individual arbitration procedure and waiver of class and representative proceedings specified in this Agreement by sending a written letter to the Epson Address within thirty (30) days of your assent to this Agreement (including without limitation the purchase, download, installation of the Software or other applicable use of Epson Hardware, products and services) that specifies (i) your name, (ii) your mailing address, and (iii) your request to be excluded from the final, binding individual arbitration procedure and waiver of class and representative proceedings specified in this Section 1. In the event that you opt-out consistent with the procedure set forth above, all other terms shall continue to apply, including the requirement to provide notice prior to litigation.

1.8 Amendments to Section 1. Notwithstanding any provision in this Agreement to the contrary, you and Epson agree that if Epson makes any future amendments to the dispute resolution procedure and class action waiver provisions (other than a change to Epson's address) in this Agreement, Epson will obtain your affirmative assent to the applicable amendment. If you do not affirmatively assent to the applicable amendment, you are agreeing that you will arbitrate any Dispute between the parties in accordance with the language of this Section 1 (or resolve disputes as provided for in Section 1.7, if you timely elected to opt-out when you first assented to this Agreement).

1.9 Severability. If any provision in this Section 1 is found to be unenforceable, that provision shall be severed with the remainder of this Agreement remaining in full force and effect. **The foregoing shall not apply to the prohibition against class or representative actions as provided in Section 1.5. This means that if Section 1.5 is found to be unenforceable, the entire Section 1 (but only Section 1) shall be null and void.**

Parent topic: [Notices](#)

Trademarks

EPSON®, SureColor®, and PrecisionCore® are registered trademarks and EPSON Exceed Your Vision is a registered logomark of Seiko Epson Corporation.

Windows is a registered trademark of Microsoft Corporation in the United States and/or other countries.

Apple, App Store, AirPrint, AirPrint logo, iPad, iPhone, iPod touch, Mac, and OS X are trademarks of Apple Inc., registered in the U.S. and other countries.

Wi-Fi Direct® is a registered trademark of Wi-Fi Alliance®.

General Notice: Other product names used herein are for identification purposes only and may be trademarks of their respective owners. Epson disclaims any and all rights in those marks.



Parent topic: [Notices](#)

Copyright Notice

All rights reserved. No part of this publication may be reproduced, stored in a retrieval system, or transmitted in any form or by any means, electronic, mechanical, photocopying, recording, or otherwise, without the prior written permission of Seiko Epson Corporation. The information contained herein is designed only for use with this Epson product. Epson is not responsible for any use of this information as applied to other products.

Neither Seiko Epson Corporation nor its affiliates shall be liable to the purchaser of this product or third parties for damages, losses, costs, or expenses incurred by purchaser or third parties as a result of: accident, misuse, or abuse of this product or unauthorized modifications, repairs, or alterations to this product, or (excluding the U.S.) failure to strictly comply with Seiko Epson Corporation's operating and maintenance instructions.

Seiko Epson Corporation shall not be liable for any damages or problems arising from the use of any options or any consumable products other than those designated as Original Epson Products or Epson Approved Products by Seiko Epson Corporation.

Seiko Epson Corporation shall not be held liable for any damage resulting from electromagnetic interference that occurs from the use of any interface cables other than those designated as Epson approved Products by Seiko Epson Corporation.

This information is subject to change without notice.

[A Note Concerning Responsible Use of Copyrighted Materials](#)
[Default Delay Times for Power Management for Epson Products](#)
[Copyright Attribution](#)

Parent topic: [Notices](#)

A Note Concerning Responsible Use of Copyrighted Materials

Epson encourages each user to be responsible and respectful of the copyright laws when using any Epson product. While some countries' laws permit limited copying or reuse of copyrighted material in certain circumstances, those circumstances may not be as broad as some people assume. Contact your legal advisor for any questions regarding copyright law.

Parent topic: [Copyright Notice](#)

Default Delay Times for Power Management for Epson Products

This product will enter sleep mode after a period of nonuse. This is to ensure that the product meets Energy Star standards of energy efficiency. More energy savings can be achieved by setting the time to sleep to a shorter interval.

Parent topic: [Copyright Notice](#)

Copyright Attribution

© 2020 Epson America, Inc.

04/20

CPD-58953

Parent topic: [Copyright Notice](#)